

 **IZELTAS**[®]

OCAK 2024 FİYAT KATALOĐU



2024

 **YERLİ
ÜRETİM**

GRAND MASTER

TAKIM DOLABI

251 PARA

Ölü: 470x1224x964 mm

Ürün Kodu: 13000005434



IZELTAS®

A - KAPSAM İÇİ

1. Normal kullanım şartlarına uygun kullanılan ancak, imalat veya malzeme hatası tespit edilen ürünler, ömür boyu garanti kapsamında, tamir edilir veya mümkün değilse, derhal yenisi ile değiştirilir.

B - KAPSAM DIŞI

Aşağıda yazılı şartlarda kullanılan aletler, garanti kapsamı dışında olup, yenisi ile değiştirilmezler.

1. Kullanım amacı veya kullanma talimatı dışında kullanılmış olan ürünler.
2. Aşırı zorlama ile, boru takılarak veya çekiçle vurularak darbeli kullanım sonucu deforme olmuş ya da kırılmış olan ürünler.
3. Kullanıcı tarafından üzerinde taşlama, zımparalama, delme veya kaynak yapılarak orijinal hali bozulmuş olan ürünler.
4. Kullanıldıktan sonra, gerekli koruyucu bakımları yapılmadan, tozlu, rutubetli ve çamurlu ortamlarda bekletilerek fonksiyonu kaybolmuş ürünler.
5. Uygun olmayan rutubetli ortamlarda, uzun süre stoklanarak, paslanmış, korozyona uğramış olanlar.
6. Uzun süre kullanılmış veya kullanım ömrünü tamamlamış, buna bağlı olarak eskimiş, yıpranmış, deforme olmuş ürünler.

EMNİYETLİ VE DOĞRU EL ALETİ KULLANIM KURALLARI**A - UYULMASI GEREKEN KURALLAR:**

1. Anahtarın ölçüsünün kullandığınız parçaya göre uygun olduğundan emin olunuz.
2. Kullanım esnasında aletin doğru şekilde yerleştirildiğinden emin olunuz.
3. Aleti sık kontrol ediniz. Aşınmış, zarar görmüş aletleri değiştiriniz.
4. Aleti kullanım şartlarına uygun olarak kullanınız, aşırı yük uygulamayınız.
5. Özellikle çekiçlerde vurma yüzeyinin, vurulan yüzeyden daha büyük olmak zorunda olduğuna dikkat ediniz.
6. Havalı aletlerde daima uygun aksesuarı kullanınız. (Ayrıca basınçlı havanın yağlandığından emin olunuz.)
7. Çalışma şartlarına göre uygun kişisel koruma teçhizatı kullanınız.
8. Tekerlekli takım dolaplarını, daima kapılarını ve hareketli bölümlerini kilitledikten sonra hareket ettiriniz.
9. Tekerlekli takım dolabı üzerinde çalışırken, tekerleklerini frenleyiniz.
10. Yüksek gerilimli çalışma ortamlarında TS EN IEC 60900 Standartına uygun olarak üretilmiş VDE belgeli ürünleri kullanınız.
11. Aletlerin nemli ve ıslak ortamlarda kullanımı ardından mutlaka kurutunuz ve hafif yağlayınız.

B - YAPILMAMASI GEREKEN İŞLEMLER:

1. Boru vb. uzatmalar kullanılarak olması gereken tork gücünü aşmayınız. (Özellikle tüm anahtarlarda)
2. Hiçbir aleti üretim maksadına aykırı işlerde kullanmayınız. (örneğin: tornavidanın levye veya keski gibi kullanımı)
3. Aşırı güç uygulayarak (boru takarak veya çekiçle vurarak) aleti zorlamayınız. (örneğin: anahtarlar ve tornavidalar)
4. Hiçbir zaman, kullandığınız aleti kendinden daha sert olan bir cisme vurmeyiniz. (örneğin: çekiç ve keski)
5. Aletleri değişikliğe uğratmayınız. (Şekli veya bir kısmını)
6. Metrik ölçülü anahtarları, inch ölçülü civatalarda kullanmayız veya tersini yapmayınız.
7. Yıpranmış ve hatalı aletleri kullanmayınız.
8. Tekerlekli tamir dolabı dolu iken, birden fazla çekmeceyi açık tutmayınız, çekmeceler açıkken hareket ettirmeyiniz.
9. Aletin fonksiyonunu iyileştirmek maksadı ile üzerinde zımpara, taş, kaynak vb. işlem yapmayınız.
10. Aletin kullanımı sırasında boya veya kaplamanın çıkacağı etkilere maruz bırakmayınız. Aksi halde korozyon dayanımı negatif etkilenecektir.
11. İzolasyonu zedelenmiş, sapı yıpranmış VDE sertifikalı ürünleri hiçbir şekilde yüksek gerilim ihtiva eden ortamlarda kullanmayınız.
12. Kontrol kaleminin iç mekanizmasını kesinlikle sökmeye çalışmayınız. Kontrol kalemleri 110 – 250 VAC çalışma aralığı için uygundur.
13. Yukarıda bahsedilen şartlara ve doğru kullanıma riayet ederek, her zaman amaca yönelik uygun aletleri kullanınız.

A - INCLUDED CASES

1. Products used in accord with normal use conditions but found to have production or material errors will be repaired or if this is not possible replaced immediately under lifetime warranty.

B - EXCLUDED CASES

Products used under any of the conditions listed below are excluded from the warranty scope and cannot be replaced with new ones:

1. Products used outside the intended purpose or instructions of use;
2. Products deformed or broken due to excessive forcing, pipe attachment or hammer impact;
3. Products whose original form is altered by the user by stoning, grinding, perforation or welding;
4. Products which lost their function due to being left in dusty, moist or muddy environments without necessary protective maintenance after use;
5. Products which became rusted or corroded due to being stored in unsuitable, moist environments for extended periods of time;
6. Products which are used for a long period of time or which have completed their useful life and accordingly have become old, worn out and deformed.

RULES FOR SAFE AND CORRECT USE OF HAND TOOL**A - PRACTICAL RULES:**

1. Make sure size of the wrench is appropriate for the work piece.
2. Make sure the tool is positioned correctly during use.
3. Frequently control the tool. Replace worn or damaged tools.
4. Use the tool in accord with instructions of use. Do not place too much load on the tool.
5. Especially beware of the point that the impact surface of a hammer must be larger than the impacted surface.
6. Always use appropriate accessories for pneumatic tools. (Also make sure the pneumatic system is properly lubricated.)
7. Use personal protection equipment appropriate for work conditions.
8. Always make sure to lock lids and moving parts of wheeled set cabinets before moving them.
9. Make sure to lock brakes of the wheeled set cabinets before working on them.
10. Use VDE certified products made in accord with TS EN IEC 60900 Standard in high voltage work environments.
11. Make sure to dry and lightly lubricate tools after use in moist and wet environments.

B- ACTIONS TO AVOID:

1. In case of use with extensions like pipes, etc. do not exceed the specified torque value (especially in case of all wrenches).
2. Do not use any tool outside of its intended purpose (e.g. do not use a screwdriver as a lever or a chisel).
3. Do not force the tool (e.g. wrenches and screwdrivers) by using excessive force (by pipe attachment or hammer impact).
4. Never use the tool to hit another object harder than the tool (e.g. hammer and chisels).
5. Do not alter the tools (in form or partially).
6. Do not use metric sized wrenches on inch sized bolts or vice-versa.
7. Do not use worn out or faulty tools.
8. Do not leave multiple drawers open when using the wheeled set cabinet and do not move the cabinet while the drawers are open.
9. Do not perform grinding, stoning, welding, etc. on the tool in order to improve its function.
10. Do not expose the tool to conditions that might result in loss of paint or coating during use. Otherwise corrosion resistance of the tool will be affected.
11. Never use VDE certified products with damaged or worn isolation or handle in high voltage work environments.
12. Never attempt to dismantle the internal assembly of the tester. Testers are suitable for use in the 110 – 250 VAC operation range.
13. Always use the right tool for the right job and follow the conditions and rules of correct usage detailed above.

Yarım asırlık 'güven'

Kalite yolculuğu inanmakla başlar.

Türkiye'nin ilk ve en büyük el aletleri üreticisi İZELTAŞ, 1968 yılında Ege'nin gözbebeği İzmir'den işte bu inançla yola çıktı. Yüzde 100 Türk sermayesiyle oluşturulan ve günden güne büyüyen İZELTAŞ, modern teknolojiyle donatılmış dev tesislerinde üretilen dört bin beş yüz den fazla ürünle 40 ülkeye ihracat yaparak hem kendi insanına hem de ülke ekonomisine katkı sağlıyor.

El aletlerinin yanı sıra üretilen dövme parçalar ile başta otomotiv olmak üzere inşaat, denizcilik ve madencilik sektörüne, savunma ve havacılık sanayilerine, ziraat endüstrisine, altyapı işlerine dek birçok kamu ve özel sektör kuruluşuna hizmet sunuyor.

Daha iyisi, daha yenisi için...

Kalıphane, dövme, işleme, ısıtma işlem, krom-nikel kaplama, boyama, plastik daldırma, plastik enjeksiyon ve markalama departmanlarından oluşan dünyadaki ender entegre fabrikalardan İZELTAŞ'ta üretimin her aşamasında kalite kontrolüne tabi tutulan ürünler; fiziksel, metalürjik, kimyasal ve elektriksel testlerden geçirilerek İZELTAŞ güvencesine alınıyor. Ar-Ge ve inovasyon ışığında değişime ve gelişime her daim açık olan İZELTAŞ, bu sayede gücüne güç katıyor.

T.C. Sanayi ve Teknoloji Bakanlığında AR-GE Merkezi belgesine sahip İZELTAŞ, TS EN ISO 9001 Kalite Yönetim Sistemi, ISO/IEC 27001 Bilgi Güvenliği Yönetim Sistemi, TS (OHSAS) 18001 İş Sağlığı ve Güvenliği Yönetim Sistemi, TS EN ISO 14001 Çevre Yönetim Sistemi, TS EN ISO 50001 Enerji Yönetim Sistemleri; TSE, TSEK, VDE GS ürün kalite belgeleri ve yüksek teknolojisi ile sadece Türkiye'de değil, dünyada da farkını ortaya koyuyor.

Önce güvenlik, sonra üretim

İnsan önemli, emek değerlidir. İZELTAŞ, "Önce güvenlik" anlayışından ayrılmadan, çalışanları için önlem almaya, onları iş sağlığı ve güvenliği konusunda eğitmeye devam ediyor. Çünkü; "İnsan vücudunun yedek parçası yoktur"

Size ulaştıktan sonra...

Satış sonrasında tüketici haklarını koruma ve sınırsız hizmet anlayışı İZELTAŞ'ın vazgeçilmez şirket politikalarından birini oluşturuyor.

Dolayısıyla...

- El aletleri' dendiğinde akla gelen ilk isim olabildiysek,
- Yarım asırdır 'aileden biri' olmanın hakkını verebildiysek,
- 'Türk malı' sözünün altına imzamız atabildiysek,
- 'Yıllarca kullanılır' diyerek her zaman tercih edildiysek,

Gücümüzü, şevkimizi ve inancımızı siz değerli bayilerimiz ve tüketicilerimizden alıyoruz.

850 çalışanımızla birlikte üreterek, değer sağlayarak dünya markası olmanın haklı gururunu yaşıyoruz.

Nice başarılı yıllara!

Half a century of reliability

Faith is the essential step on the journey to achieve utmost quality.

As the first and largest hand tool manufacturer of Turkey, İZELTAŞ, had this faith as it started its journey in 1968 in İzmir, the beautiful city in the Aegean region. Its establishment, consisting of 100% national capital, İZELTAŞ has grown in years into an industrial giant with huge facilities equipped with state-of-the-art technologies and over 4500 products. Exporting to more than 40 countries, the company is a prominent contributor to not only the Turkish economy but also the community.

Along with manufacturing hand tools, İZELTAŞ produces forged steel parts for various industries like automotive, construction, maritime, mining, aviation, defence, agriculture and infrastructure.

Newer and better

İZELTAŞ is one of the few fully integrated factories in the world that consists of die tooling, forging, processing, heat processing, chrome-nickel plating, dyeing, pvc coating, plastic injection and marking departments. Every stage of the production is tested for quality assurance using physical, metallurgical, chemical and electrical methods. R&D and innovation are the key words that empower İZELTAŞ as a company which embraces development and improvement as its main philosophy.

İZELTAŞ is an accredited R&D Center by the Ministry of Science, Industry and Technology and has been certified with the following: ISO 9001 Quality Management System, ISO/IEC 27001 Informationsecurity Maniagement System, OHSAS 18001 Occupational Health and Safety Management System, ISO 14001 Environment Management System, ISO 50001 Energy Management System certification, TSE, TSEK and VDE GS product certification.

Safety before production

Humans are the most significant factors of any industry and their labour is precious. Health and safety awareness is the fundamental policy of İZELTAŞ. The company continuously organizes training programs on occupational health and safety which emphasise that safety comes first and it is not possible to fix humans by changing the damaged organs with spare ones.

Customer satisfaction

Another fundamental policy of İZELTAŞ is the customer satisfaction. The company is dedicated to serve its customers and protect their rights as consumers.















Hence...

- We are the first brand that comes to mind in the hand tools industry
- We are valued almost as a part of the families of our consumer
- We have proved ourselves worthy of the statement "Made in Turkey"
- We have been the first choice of the consumers for durability over the years

Our power, enthusiasm and faith are derived from our distinguished dealers and consumers.

We are proud to have become a world brand with our 850 employees who strive everyday to contribute to the productivity of the company, creating an added value for the economy and our community.

To many successful years to come!

Takım Dolapları ve Takım Çantaları / Tool Trolleys, Tool Boxes	6-69	
Anahtarlar / Wrenches	70-92	
Lokma ve Bijon Anahtarları / Sockets and Rim Wrenches	93-120	
Havalı Lokma ve Bijon Anahtarları / Air Pressured Sockets and Rim Wrenches	121-129	
Boru Anahtarları ve Penseler / Pipe Wrenches and Pliers	130-150	
1000V Grubu Ürünler / 1000V Product Group	151-159	
Tornavida ve Allen Anahtarlar / Screwdrivers and Hex Key Wrenches	160-184	
Keskiler ve Çekiçler / Chisels and Hammers	185-192	
Genel El Aletleri / General Hand Tools	193-205	
Maket Bıçakları / Utility Knives	206-210	
Makaslar / Shears	211-218	
Çektirmeler / Pullers	219-225	
Elta Ürünleri / Elta Products	226-240	elta
Yedek Parçalar / Spare Parts	241-245	
Ticari Teşhir Standları / Commercial Display Stands	246-250	
Teknik Bilgiler ve İndeks / Technical Information and Index	251-287	



*"Sadece el aleti üretmiyoruz;
el aletleriyle her şeyi üretiyoruz."*

*"We don't just produce hand tools;
we build everything with hand tools."*

İZELTAS®

TAKIM DOLAPLARI TAKIM ÇANTALARI VE ALET SETLERİ

TOOL TROLLEYS, TOOL BOXES AND
HAND TOOL SETS

Takim Dolapları
Tool Cabinets

Takim Çantaları
Tool Boxes

Servis Masaları
Service Tables

Alet Setleri
Tool Sets

Soyunma Dolapları
Lockers

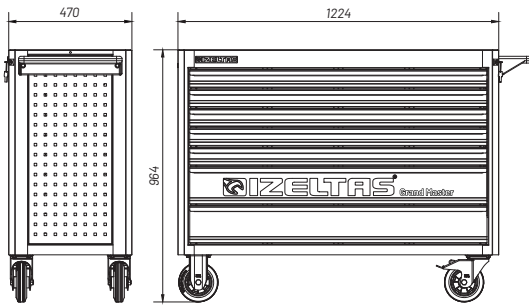

İZELTAS YOUTUBE

Grand Master Seri Takım Dolabı (7 Çekmeceli)
Grand Master Series Workshop Trolley (7 Drawers)

Ölçü/Size: 470x1224x964 mm

- ✓ 18mm masif üst tabla
- 18 mm solid wood top



- ✓ Ergonomik sap
- Ergonomic handle



- ✓ %100 açılabilir teleskobik raylar
- %100 extendable telescopic slides

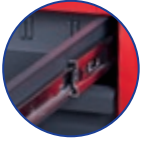

- ✓ 2 sabit, 2 hareketli frenli tekerlek ø 150mm
- 2 swivel castors with brake
- 2 fixed castors ø 150mm



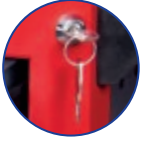

- ✓ Merkezi kilit
- ✓ Mandal sistemi
- ✓ Devrilme emniyet sistemi
- Central lock
- Handgrip Lock system
- Anti tilt system



- ✓ Yüksek dayanımlı elektrostatik toz boya
- High strength electrostatic powder coating.

**Sacdan imal edilmiş, Fırın boya**
Made of sheet metal, Electrostatic paint

KOD/CODE	ÇEKMECE DRAWERS	 3.5 kg	 3.5 kg	 Kg	RENK COLORS	TL/Ad
8246 32 1007	7	1098x400x60	1098x400x135	125.7		31.815,50
13000 005434 Dolu/Full 251 Parça/Pcs	7	5X	2X	125.7	RAL 9005 GOF RAL 3020 GOF	119.292,25

1. Grand Master Seri Çekmece/Drawer



Sol Taraf / Left Side Kod / Code 13000 005590

KOD CODE	İÇERİK CONTENTS	☐	TL/Ad
0330	Kombine Anahtar Uzun Boy Combination Wrench Long Pattern 6 - 7 - 8 - 9 - 10 - 11 - 12 - 13 - 14 - 15 - 16 - 17 - 18 - 19 - 20 - 21 - 22 - 23 - 24 - 25 - 26 - 27 - 28 mm	23	5.020,25

Sağ Taraf / Right Side Kod / Code 13000 005589

KOD CODE	İÇERİK CONTENTS	☐	TL/Ad
0330	Kombine Anahtar Uzun Boy Combination Wrench Long Pattern 29 - 30 - 32 - 34 - 36 - 41 mm	6	3.129,00

2. Grand Master Seri Çekmece/Drawer



Sol Taraf / Left Side Kod / Code 13000 005591

KOD CODE	İÇERİK CONTENTS	☐	TL/Ad
0130	İki Ağız Anahtar Uzun Boy Double Ended Open Jaw Wrench Long Pattern 6x7 - 8x9 - 10x11 - 12x13 - 14x15 - 16x17 - 18x19 - 20x22 - 21x23 - 24x26 - 25x28 - 27x32 - 36x41 mm	13	2.470,50

Sağ Taraf / Right Side Kod / Code 13000 005592

KOD CODE	İÇERİK CONTENTS	☐	TL/Ad
0430	Yıldız İki Ağız Anahtar Double Ended Ring Wrench 6x7 - 8x9 - 10x11 - 12x13 - 14x15 - 16x17 - 18x19 - 20x22 - 21x23 - 24x26 - 25x28 - 27x32 - 36x41 mm	13	4.092,00

3. Grand Master Seri Çekmece/Drawer



Sol Taraf / Left Side Kod / Code 13000 005594

KOD CODE	İÇERİK CONTENTS	☐	TL/Ad
3301	Dış Segman Pense Yaylı Düz Circlip Pliers, External (Flat) 180 - 295 mm	2	
3311	Dış Segman Pense Yaylı Eğri Circlip Pliers, External (Bent) 170 - 275 mm	2	6.896,00
3321	İç Segman Pense Yaysız Düz Circlip Pliers, Internal (Flat) 180 - 310 mm	2	
3331	İç Segman Pense Yaysız Eğri Circlip Pliers, Internal (Bent) 170 - 290 mm	2	

Sağ Taraf / Right Side Kod / Code 13000 005593

KOD CODE	İÇERİK CONTENTS	☐	TL/Ad
0600	Kurbağacak Anahtar 12" Adjustable Wrench	1	
2400	Üniversal Fort Pense 240 mm Waterpump Pliers Universal	1	
2500	Üniversal Ayarlı Pense 250 mm Universal Grip	1	10.002,00
3020	Kombine Pense Opak Seri 180 mm Combination Pliers	1	
3220	180 mm Kargaburun Düz Uçlu Opak Long Nose Pliers	1	
3700	Yan Keski Opak Seri 160 mm Side Cutting Pliers	1	
3425	Hortum Kelepçe Pense Sıkıştırma Tipi 235 mm / Hose Clamp Pliers	1	
07415	6 Sıralı Tel Fırça Ağaç Saplı Hand Brush (Wooden Handle)	1	
6380	Çift Zincirli Yağ Filtresi Sökeceği 60x160 mm Oil Filter Wrench With Double Chain	1	
6820	Tenekeci Makası 250 mm Yaylı Tinman's Snip	1	



4. Grand Master Seri Çekmece/Drawer



Sol Taraf / Left Side

Kod / Code 13000 005595

KOD CODE	İÇERİK CONTENTS	☐	TL/Ad
4903	Allen Anahtar Takımı Altı Köşe Uzun Boy 12 Parça Hex Key Wrench Set Long Pattern	12	
4903	Allen Anahtar Altı Köşe Uzun Boy Hex Key Wrench Long Pattern 14 - 16 - 17 - 19 mm	4	5.381,75
4920	T Tipi Allen Anahtar Takımı 8 Parça Hex Key Wrench T Handle Set	8	

Sağ Taraf / Right Side

Kod / Code 13000 005596

KOD CODE	İÇERİK CONTENTS	☐	TL/Ad
4300	Opak Seri Düz Uçlu Tornavida Screwdriver, Opak, Flat 3x80 - 4x80 - 4x100 - 5x125 - 6x150 mm	5	
4320	Opak Seri Yıldız Uçlu Tornavida Screwdriver, Opak, Phillips 4.5x80 - 6x100 mm	2	
4770	Lokma Uçlu Tornavida Nut Spinner 6 - 7 - 8 - 9 - 10 - 11 - 12 - 13 mm	8	4.915,75
4780	Manyetik Bits Tutucu Tornavida Flexiblee 6.3x120 Screwdriver, Magnetic Bit Holder (Long)	1	
4800	31'li Bits Takım (Plastik Kutulu) Bit Set in Plastic Case	31	
6220	Spiralli Mıknatıs 1000 gr Flexible Magnet Holder	1	



5. Grand Master Seri Çekmece/Drawer

Sol Taraf / Left Side
Kod / Code 13000 005598
Sağ Taraf / Right Side
Kod / Code 13000 005597

KOD CODE	İÇERİK CONTENTS	☐	TL/Ad
0340	Cırcır Kombine Anahtar Combination Wrench With Ratchet 10 - 13 - 17 - 19 mm	4	
1113	1/2" Altı Köşe Lokma Anahtar Socket Wrench 6 Points 10 - 11 - 12 - 13 - 14 - 15 - 16 - 17 - 18 - 19 - 21 - 22 - 23 - 24 26 - 27 - 28 - 30 - 32 mm	19	
1113	1/2" Lokmalı Allen Uç Hexagonal Bit Socket Wrench 5 - 6 - 7 - 8 - 10 - 12 - 14 mm	7	
1113	1/2" Lokmalı Star (Torx®) Uç Star Torx® Bit Socket Wrench T25 - T27 - T30 - T40 - T45 - T50 - T55 - T60	8	9.784,25
1513	1/2" Cırcır Kolu 250 mm (32 Diş) Ratchet Handle	1	
1513	1/2" Ara Kol / Extension Bar 125 - 250 mm	2	
1513	1/2" T Kol 250 mm / Sliding T Handle	1	
1513	1/2" Mafsal 70 mm / Universal Joint	1	
1513	1/2" F x 3/4" M Lokma Adaptörü / Adapter	1	
1519	3/4" F x 1/2" M Lokma Adaptörü / Adapter	1	

KOD CODE	İÇERİK CONTENTS	☐	TL/Ad
1113	1/2" Altı Köşe Havalı Derin Lokma Anahtar Impact Socket Wrench 6 Points 10 - 11 - 12 - 13 - 14 - 15 - 16 - 17 - 18 - 19 - 21 - 22 - 24 - 27 - 30 - 32 mm	16	
1513	1/2" Fx3/4" M Havalı Lokma Adaptörü Impact Socket Adapter	1	
1513	1/2" Havalı Lokma Ara Kol 125 mm Impact Socket Extension Bar	1	
1513	1/2" Havalı Lokma Mafsal 75 mm Impact Socket Universal Joint	1	
1119	3/4" Altı Köşe Havalı Lokma Anahtar Impact Socket Wrench 6 Points 19 - 21 - 22 - 24 - 27 - 30 - 32 - 34 - 36 - 41 - 46 mm	11	16.310,25
1519	3/4" Havalı Lokma Ara Kol 250 mm Impact Socket Extension Bar	1	
1519	3/4" Havalı Lokma Mafsal 108 mm Impact Socket Universal Joint	1	
1519	3/4" F x 1/2" M Havalı Lokma Adaptörü Impact Socket Adapter	1	



6. Grand Master Seri Çekmece/Drawer



Sol Taraf / Left Side

Kod / Code 13000 005600

Sağ Taraf / Right Side

Kod / Code 13000 005599

KOD CODE	İÇERİK CONTENTS	☐	TL/Ad
5010	Iskarpela Düz 22 mm Wood Chisel	1	
5800	Tesviyeci Çekiç Machinist Hammer 2000 - 500 gr	2	
5850	Plastik Çekiç 40 mm Plastic Hammer	1	
05881	Plastik Şerit Metre 5 m Plastic Steel Case Measuring Tapes	1	5.421,50
	Topuklu Keçe Levyesi 400 mm Prybar	1	
5500	Düz Keski 250 mm Flat Cold Chisel	1	
	Antifriz Bomesi Antifreeze tester	1	

KOD CODE	İÇERİK CONTENTS	☐	TL/Ad
1119	3/4" Altı Köşe Lokma Anahtar Socket Wrench 6 Points 22 - 24 - 27 - 30 - 32 - 34 - 36 - 41 - 46 - 50 - 55 - 60 mm	12	
1519	3/4" Cırcır Kolu 510 mm Ratchet Handle	1	
1519	3/4" Ara Kol Extension Bar 200 - 400 mm	2	12.363,50
1519	3/4" T Kol 500 mm Sliding T Handle	1	

7. Grand Master Seri Çekmece/Drawer

Gres Pompası / Grease Gun



Gres Pompası Hortumu / Hose for Grease Gun



Levye Oluklu Kıvrık Uçlu / Tyre Lever, Bent



KOD CODE	İÇERİK CONTENTS	☐	TL/Ad
6230	Gres Pompası (500 cc) Grease Gun	1	886,25
6230	Gres Pompası Hortumu Hose for Grease Gun	1	172,25
6360	Levye Oluklu Kıvrık Uçlu 600 mm Tyre Lever, Bent	2	631,50



Premium Serisi Takım Dolabı (5-7 Çekmeceli)

Premium Series Workshop Trolley (5-7 Drawers)



✓ 7 bölmeli sağlam ve dayanıklı ABS plastik üst malzeme tabla.
● Resistant and solid top cover having 6 divisions

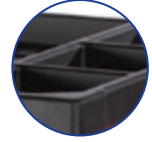

✓ %100 açılabilir teleskobik raylar.
● %100 extendable telescopic slides



✓ Merkezi kilit
✓ Mandal sistemi
✓ Devrilme emniyet sistemi
● Central lock
● Handgrip Lock system
● Anti tilt system



✓ 2 sabit, 2 hareketli frenli tekerlek ø 125mm
● 2 swivel castors with brake
2 fixed castors ø 125mm



✓ Standard tutma sapı
● Standard handle



✓ Plastik köşe koruma
● Plastic corner protection



✓ Yüksek dayanımlı elektrostatik toz boya
● High strength electrostatic powder coating



✓ Havluluk x1
Avadanlık x2 Askılık x1
● Paper Roll Holder
x1 Bottle & Tins Holder x2 Hanger x1

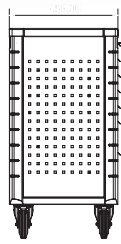
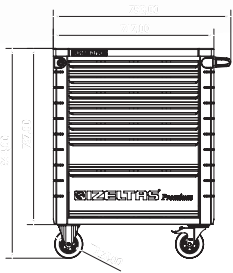
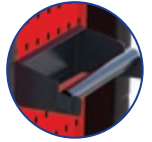



İZELTAS YOUTUBE

Ölçü/Size: 485x717x944 mm

Sacdan imal edilmiş, Fırın boya
Made of sheet metal, Electrostatic paint

RAL 9005 GOF
RAL 3020 GOF

KOD/CODE	ÇEKMECE DRAWERS	 35 kg	 35 kg	 35 kg	Kg	TL/Ad
		400x548x63	400x548x132	400x548x202		
8245 32 1005	5	2X	1X	2X	64	20.641,75
8245 32 1007	7	5X	1X	1X	70	26.721,75
8245 00 7096 Dolu/Full 250 Parça/Pcs	7	5X	1X	1X		67.051,00

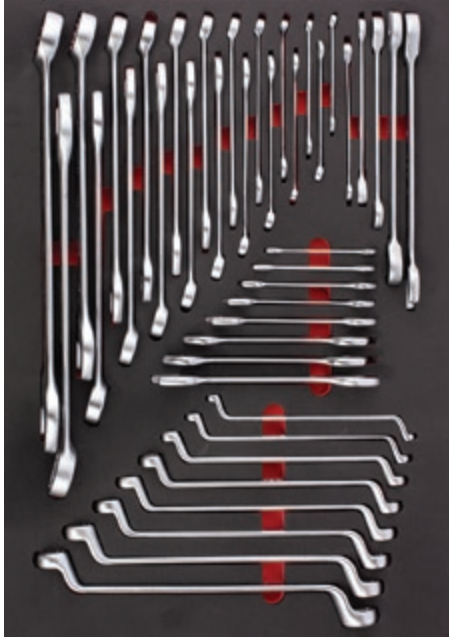

1. Premium Seri Çekmece/Drawer Kod / Code 8245001042

KOD CODE	İÇERİK CONTENTS	☐	TL/Ad
0100	İki Ağız Anahtar Kısa Boy D/E Open Jaw Wrenches Short Pattern 6x7-8x9-10x11-12x13-14x15-16x17-18x19-20x22	8	
0320	Kombine Anahtar Kısa Boy Combination wrenches Short Pattern 6-7-8-9-10-11-12-13-14-15-16-17-18-19-20-21-22-24-27-30-32	21	9.011,50
0430	Yıldız Anahtar Ring Wrenches 6x7-8x9-10x11-12x13-14x15-16x17-18x19-20x22	8	
0340	Cırcır Kombine Anahtar / Combination Wrench With Ratchet 8-10-13-17-19	5	

2. Premium Seri Çekmece/Drawer Kod / Code 8245002094

KOD CODE	İÇERİK CONTENTS	☐	TL/Ad
1107	1/4" Lokmalı Allen Uçlar / Hexagonal Bits Socket 2,5-3-4-5-6-7-8-10	8	
1107	1/4" Lokmalı Torx Uç / Torx Bits Socket T8-T9-T10-T15-T20-T25-T27-T30-T40	9	
1107	1/4" Lokmalı Yıldız Uç / Phillips Bits Socket PH1-PH2-PH3	3	
1107	1/4" Lokmalı Düz Uç / Slotted Bits Socket 3-4-5,5-6,5	4	
1107	1/4" Altı Köşe Derin Lokma / Deep Socket Wrench 6 Point 4-5-5,5-6-7-8-9-10-11-12-13	11	
1113	1/2" Lokmalı Allen Uç / Hexagonal Bits Socket 5-6-7-8-10-12-14	7	
1113	1/2" Lokmalı Torx Uç / Torx Bits Socket T20-T25-T27-T30-T40-T45-T50-T55-T60	9	
1107	1/4" Altı Köşe Lokma Takımı / Socket Wrench Set 1/4" Cırcır kolu / Ratchet Handle 1/4" Mafsal / Universal Joint 1/4" T Kol / Sliding T Handle	15	10.001,00
1113	1/4" Ara Kol / Extension Bar 50-100 mm 1/2" Buji Lokma Lastikli Spark Plug Socket With Rubber 16 mm	1	
1113	1/2" Lokma Takımı / Socket Wrench Set 10 - 11 - 12 - 13 - 14 15 - 16 - 17 - 18 - 19 21 - 22 - 23 - 24 1/2" Cırcır Kolu 32 Diş / Ratchet Handle 1/2" Mafsal / Universal Joint 1/2" T Kol Adaptör / Sliding T Handle Adapter 1/2" Ara Kol / Extension Bar 125-250 mm	24	

3. Premium Seri Çekmece/Drawer Kod / Code 8245003014

KOD CODE	İÇERİK CONTENTS	☐	TL/Ad
3700	Yan Keski Opak Seri / Side Cutting Pliers 160 mm	1	
3020	Kombine Pense Opak Seri / Combination Pliers 180 mm	1	
3220	Kargaburun Düz Uçlu Opak Seri / Nose Pliers Flat 180 mm	1	
4300	Opak Seri Düz Uçlu Tornavida / Screwdriver, Flat 3x80-5x125-7x150	3	4.657,25
4320	Opak Seri Yıldız Uçlu Tornavida / Screwdriver, Philips 3x60-4.5x80-6x100-8x150	4	
3301	Dış Segman Pensi Düz / Circlip Pliers, External Flat 140-180mm	2	
3321	İç Segman Pensi Düz / Circlip Pliers, Internal Flat 140-180mm	2	



4. Premium Seri Çekmece/Drawer Kod / Code 8245004043

KOD CODE	İÇERİK CONTENTS	☐	TL/Ad
4770	Lokma Uçlu Tornavida / Nutspinner 6-7-8-9-10-13	6	
4910	Torx Allen Takım / Torx Key Wrench Set T9-T10-T15-T20-T25-T27-T30-T40	8	
4900	Allen Takımı 6 Köşe / Hex Key Wrench Set 2-2.5-3-3.5-4-5-6-7-8-9-10-12	12	5.320,00
4906	Yuvarlak Başlı Uzun Allen Takımı / Hex key Wrench Ballpoint Long Pattern Set 1.5-2-2.5-3-4-5-6-8-10	9	
4920	T Tipi Allen Anahtar / T Type Hex Key Wrench 2.5-3-4-5-6-7-8-10	8	



5. Premium Seri Çekmece/Drawer Kod / Code 8245005043

KOD CODE	İÇERİK CONTENTS	☐	TL/Ad.
4565	Oto Elektrik Kontrol Kalem / Car Voltage Tester 135mm	1	
07415	Sıralı Tel Fırça 4 Sıralı / Hand Brush 4 Raws	1	
2400	Üniversal Fort Pense / Waterpump Pliers Universal 240 mm	1	
2500	Üniversal Ayarlı Pense / Universal Grip 250 mm	1	
0600	Kurbağacık Anahtar / Adjustable Wrench 10"	1	
4780	Manyetik Bits Tutucu Tornavida / Screwdriver, Magnetic Bit Holder 6.3x120	1	
4800	31'li Bits Set (Plastik Kutulu) / Bits Set in plastic case	31	5.732,75
4110	Düz Topaç Tornavida / Screwdriver, Stubby, Flat 6.5x25	1	
4130	Yıldız Topaç Tornavida / Screwdriver, Stubby, Phillips 6x25	1	
5500	Düz Keski Krom / Flat Cold Chisel 150 mm	1	
5800	Tesviyeci Çekici / Machinist's Hammer 300-1500 gr	2	
6350	Levye Oluklu / Tyre Lever 500 mm	1	



6. Premium Seri Çekmece/Drawer Kod / Code 8245006009

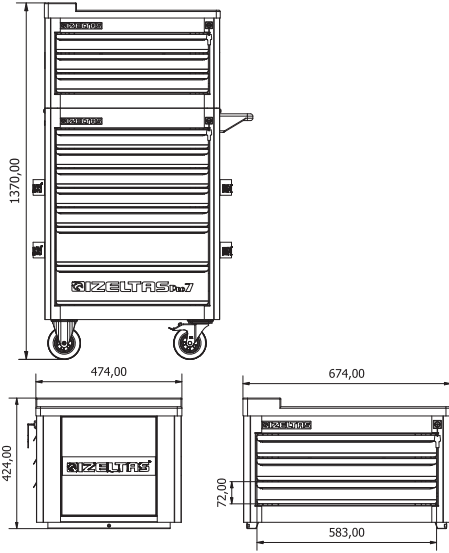

KOD CODE	İÇERİK CONTENTS	☐	TL/Ad
1840	1/2" Mafsallı T Kol Swivel Handle With Sliding T 1/2"	1	
6230	Gres Pompası Grease Gun 500cc	1	
06375	Ayarlı Yağ Filtre Sökeceği Adjustable Slot Type Oil Filter Wrench	1	5.606,75
6225	Madeni Yağdanlık (Flexible Uçlu) Oiler With Flexible Spout 200cc	1	
1113	1/2" Altı Köşe Havalı Lokma Anahtar (mm) Impact Socket Wrench 6 Points (mm) 10-13-17-19-21-24	6	
1108	1/2" Altı Köşe Havalı Derin Lokma Anahtar 6 Point Impact Socket Wrench, Long Type (mm) 10-13-17-19-21-24	6	

Pro Seri 3 Çekmeceli Dolap Üstü Dolap
Pro Series Workshop Trolley Top Unit With 3 Drawers

- ✓ Devrilme Emniyetli Sistem
- Handgrip Lock System and Antitilt System
- ✓ %100 Açılabilir Teleskopik Ray
- Telescopic Slides Which Are %100 extendable
- ✓ Merkezi Kilit Sistemi
- Central Lock System
- ✓ 1 Adet 9 Bölmeli Sağlam ve Dayanıklı ABS Üst Tabla
- Durable ABS Worktop With 9 Divisions
- ✓ 2 Adet Yan Avadanlık
- 2 Side Holders
- ✓ 10 Adet Çekmece Seperatörü
- 10 Drawer Separators
- ✓ 1 Adet Arka Avadanlık
- 1 Back Holder

Ölçü/Size: 474x674x424 mm

Sacdan imal edilmiş, Fırın boya
Made of sheet metal, Electrostatic paint

KOD/CODE	ÇEKMECE DRAWERS		 Kg	RENK COLORS	TL/Ad
13000 005279	3	400x548x68	29.2	RAL 7035 GOF RAL 3020 GOF	11.870,00

8241 PRO SERİSİ / PRO SERIES

Pro Serisi Takım Dolabı (5-6-7-8 Çekmeceli) Pro Series Workshop Trolley (5-6-7-8 Drawers)



✓ Merkezi kilit sistemi, mandal sistemi ve devrilme emniyet sistemi
● Central lock system, handgrip lock system and antitilt system



✓ Teleskobik rulmanlı kızaklar tüm çekmeceler %100 açılabilir
● Telescopic slides which are %100 extendable



✓ 9 bölmeli sağlam ve dayanıklı ABS plastik üst malzeme tabla
● 9 durable ABS worktop with divisions



✓ 2 sabit, 2 hareketli frenli tekerlek Ø 125mm
● 2 swivel castors with brake, 2 fixed castors Ø 125mm



✓ Yüksek dayanımlı elektrostatik toz boya
● High strength electrostatic powder coating

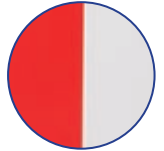

✓ Toplam 6 Adet yan ve arka avadanlık bölümleri
● 6 tool holders



İZELTAS USTA İŞİ
SOHBETLER



İZELTAS YOUTUBE

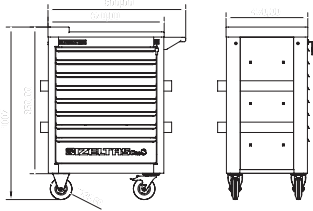

Ölçü/Size: 470x670x1007 mm





Sacdan imal edilmiş, Fırın boya
Made of sheet metal, Electrostatic paint



RAL 7035 GOF
RAL 3020 GOF

RAL 7035 GOF
RAL 5003 GOF

RAL 7035 GOF
RAL 7016 GOF

KOD/CODE	CEKMECE DRAWERS					RENK COLORS	TL/Ad
		400x548x68	400x548x143	400x548x218			
8241 32 1005	5	1X	4X	--	59		21.342,25
8241 32 1006	6	4X	1X	1X	62	RAL 7035 GOF	23.062,00
8241 32 1007	7	5X	2X	--	65	RAL 3020 GOF	27.253,50
8241 32 1008	8	7X	1X	--	67		29.051,00
8241 32 2005	5	1X	4X	--	59		21.342,25
8241 32 2006	6	4X	1X	1X	62	RAL 7035 GOF	23.062,00
8241 32 2007	7	5X	2X	--	65	RAL 5003 GOF	27.253,50
8241 32 2008	8	7X	1X	--	67		29.051,00
8241 32 3005	5	1X	4X	--	59		21.342,25
8241 32 3006	6	4X	1X	1X	62	RAL 7035 GOF	23.062,00
8241 32 3007	7	5X	2X	--	65	RAL 7016 GOF	27.253,50
8241 32 3008	8	7X	1X	--	67		29.051,00
8241 00 1209 Dolu/Full 206 Parça/Pcs	8	7X	1X	--			64.105,00

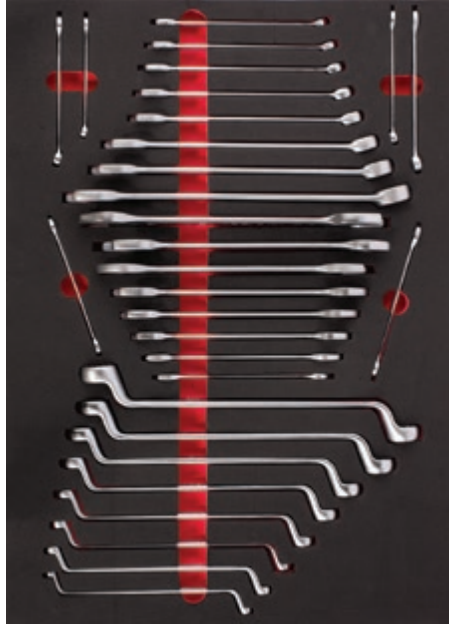

1. Pro Seri Çekmece/Drawer		Kod / Code 8241001030	
KOD CODE	İÇERİK CONTENTS	☐	TL/Ad
0130	İki Ağız Anahtar Uzun Boy / D/E Open Jaw Wrench Long Pattern 6x7 - 8x9 - 10x11 - 12x13 14x15 - 16x17 - 18x19 - 20x22 21x23 - 24x26	10	
0330	Kombine Anahtar Uzun Boy / Combination Wrench Long Pattern 6 - 7 - 8 - 9 - 10 - 11 - 12 - 13 14 - 17 - 19 - 22	12	4.543,00
0430	Yıldız Anahtar / D/E Ring Wrench 6x7 - 8x9 - 10x11 - 12x13 14x15 - 16x17 18x19 - 20x22	8	



2. Pro Seri Çekmece/Drawer		Kod / Code 8241002072	
KOD CODE	İÇERİK CONTENTS	☐	TL/Ad
1107	1/4" Altı Köşe Lokma Takımı / 1/4" Socket Wrench Set 4 - 5 - 6 7 - 8 - 9 - 10 11 - 12 - 13 Altı Köşe Six Point	15	
	1/4" Cırcır kolu / 1/4" Ratchet Handle		
	1/4" Mafsal / 1/4" Universal Joint		
	1/4" T Kol / 1/4" Sliding T Handle		
	1/4" Ara Kol / 1/4" Extension Bar 50-100 mm		
1113	1/2" Lokma Takımı / 1/2" Socket Wrench Set 10 - 11 - 12 13 - 14 - 15 16 - 17 - 18 19 - 21 - 22 23 - 24 - 26 27 - 28 - 30 32	24	9.054,00
	1/2" Cırcır Kolu 32 Diş / 1/2" Ratchet Handle		
	1/2" Mafsal / 1/2" Universal Joint		
	1/2" T Kol Adaptör / 1/2" Sliding T Handle Adapter		
	1/2" Ara Kol / 1/2" Extension Bar 125-250 mm		
1113	1/2" Lokmalı Allen Uçlar / 1/2" Hexagonal Bits Sockets H5-H6-H7-H8-H10-H12-H14	7	
1113	1/2" Lokmalı Star Uç / 1/2" Star Bits Socket T20-T25-T27-T30-T40-T45-T50-T55-T60	9	
0330	Kombine Anahtar Uzun Boy / Combination Wrench Long 16-18	2	
4900	Allen Takımı 6 Köşe / Hex Key Wrench Set 2-2,5-3-3,5-4-5-6-7-8-9-10-12	12	



3. Pro Seri Çekmece/Drawer		Kod / Code 8241003051	
KOD CODE	İÇERİK CONTENTS	☐	TL/Ad
07415	Sıralı Tel Fırça 3 Sıralı / Hand Brush 3 Raws	1	
6350	Levye Oluklu / Tyre Lever 400 mm	1	
6220	Spiralli Miknatis / Flexible Magnet Holder 500 gr	1	
4110	Düz Topaç Tornavida / Screwdriver , Stubby, Flat 6.5x25	1	
4130	Yıldız Topaç Tornavida / Screwdriver , Stubby, Phillips 6x25	1	4.298,25
4770	Lokma Uçlu Tornavida / Nutspinner 6-7-8-9-10-13	6	
4780	Manyetik Bits Tutucu Tornavida / Screwdriver, Magnetic Bit Holder 6.3x120	1	
4905	Yuvarlak Başlı Allen Takımı / Hexkey Wrench Ballpoint Set 2-2,5-3-4-5-6-8-10	8	
4800	Bits Set Takım (Plastik Kutulu) / Bits Set in Plastic Case	31	



4. Pro Seri Çekmece/Drawer

Kod / Code 8241004027

KOD CODE	İÇERİK CONTENTS	<input type="checkbox"/>	TL/Ad
0340	Cırcır Kombine Anahtar / Combination Wrench With Ratchet 10-13-17-19	4	
4909	T Tipi Torx Allen Anahtar / Torx Allen Key T type T9-T10-T15-T20-T25-T27-T30-T40	8	
1108	1/2" Altı Köşe Derin Lokma / 1/2" Deep Socket Wrench, six points 10-11-12-13-14-15-16-17-18-19	10	7.477,00
1113	1/2" Altı Köşe Havalı Lokma / 1/2" Impact Socket Wrench 13-17-18-19-24	5	



5. Pro Seri Çekmece/Drawer

Kod / Code 8241005010

KOD CODE	İÇERİK CONTENTS	<input type="checkbox"/>	TL/Ad
3331	İç Eğri Segman Pense / Circlip Pliers, Internal, Bent 170 mm	1	
3321	İç Düz Segman Pense / Circlip Pliers, Internal, Flat 180 mm	1	
3311	Dış Eğri Segman Pense / Circlip Pliers, External, Bent 170 mm	1	
3301	Dış Düz Segman Pense / Circlip Pliers, External, Flat 180 mm	1	
3700	Yan Keski Opak İzole / Side Cutting Pliers, 160 mm	1	6.190,75
3220	Düz Kargaburun Opak İzole / Nose Pliers, 200 mm	1	
3020	Kombine Pense Opak İzole / Combination Pliers, 180 mm	1	
2510	Ayarlı Pense / Special Grip 250 mm	1	
0600	Kurbağacık Anahtar / Adjustable Jaw Wrench 10"	1	
2400	Üniversal Fort Pense / Waterpump Pliers Universal 240 mm	1	



6. Pro Seri Çekmece/Drawer

Kod / Code 8241006018

KOD CODE	İÇERİK CONTENTS	<input type="checkbox"/>	TL/Ad
4300	Opak Seri Düz Uçlu Tornavida / Opak Screwdriver, Flat 4x100-5x125-6x150-8x175	4	
4320	Opak Seri Yıldız Uçlu Tornavida / Opak Screwdriver, Phillips 4.5x80-6x100	2	
5800	Tesviyeci Çekiç / Mechanist Hammer 300 gr	1	
5850	Plastik Çekiç / Plastic Hammer ø30	1	3.491,00
5545	Konik Pim Zimba / Drift Punch 5 mm	1	
5550	Düz Pim Zimba / Split Pin Punch 5 mm	1	
5540	Nokta Zimba / Center Punch 5x120	1	
5500	Düz Keski / Flat Cold Chisel 150 mm	1	
4920	T Tipi Allen Anahtar / T Type Hex Key Wrench 3-4-5-6-7-8	6	

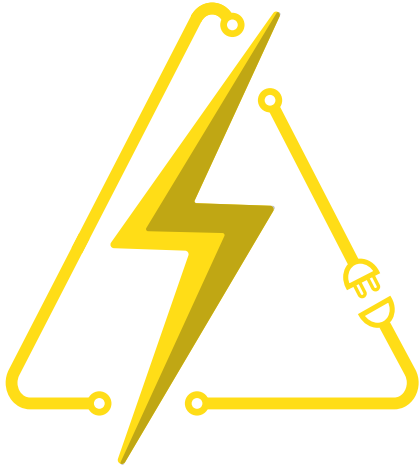

ELEKTRO



ELEKTRO SERİSİ / ELECTRO SERIES

Elektro Serisi Takım Dolabı (7 Çekmeceli) Electro Series Workshop Trolley (7 Drawers)



✓ 7 bölmeli sağlam ve dayanıklı
ABS plastik üst malzeme tabla
● Resistant and solid top
cover having 7 divisions

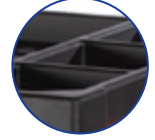

✓ %100 açılabilir
teleskobik raylar
● %100 extendable
telescopic slides



✓ Merkezli kilit
✓ Mandal sistemi
✓ Devrilme emniyet sistemi
● Central lock
● Handgrip Lock system
● Anti tilt system



✓ 2 sabit, 2 hareketli
frenli tekerlek ø 125mm
● 2 swivel castors with brake
2 fixed castors ø 125mm



✓ Standard tutma sapı
● Standard handle



✓ Plastik köşe koruma
● Plastic corner
protection

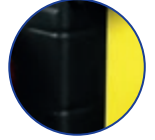

✓ Yüksek dayanımlı
elektrostatik gofrato toz boya
● High strength electrostatic
gofrato powder coating

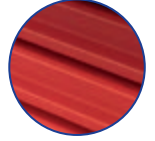

✓ Havluluk x1
Avadanlık x2 Askılık x1
● Paper Roll Holder
x1 Bottle & Tins
Holder x2 Hanger x1



✓ Magnet Uyarı Etiketi
● Magnet Warning Sticker



✓ Delikli Sac Pano ve
20 Adet Askı Teli
● Perforated Panel for
Hand Tools

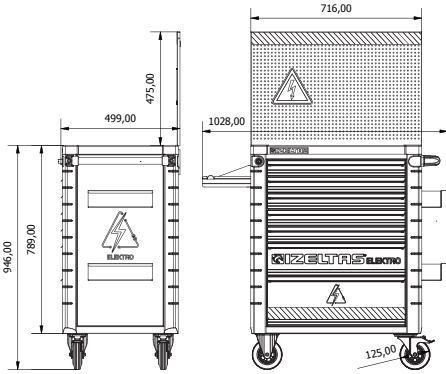



Ölçü/Size: 500x715x945 mm

Sacdan imal edilmiş, Fırın boya
Made of sheet metal, Electrostatic paint

RAL 9005 GOF

RAL 3020 GOF

RAL 1016

KOD/CODE	ÇEKMECE DRAWERS				Kg	TL/Ad
13000 005547	7	400x548x63	400x548x132	400x548x202		28.540,00
13000 005548 Dolu/Full 94 Parça/Pcs	7	5X	1X	1X		63.426,25



1. Elektro Seri Çekmece/Drawer Kod / Code 13000 005568

KOD CODE	İÇERİK CONTENTS	☐	TL/Ad.
0255 01 0010	Süper İzole Çatal Bir Ağız Anahtar 10 mm / Single Ended Open Jaw Wrench Super Insulated	1	6.605,00
0255 01 0011	Süper İzole Çatal Bir Ağız Anahtar 11 mm / Single Ended Open Jaw Wrench Super Insulated	1	
0255 01 0012	Süper İzole Çatal Bir Ağız Anahtar 12 mm / Single Ended Open Jaw Wrench Super Insulated	1	
0255 01 0013	Süper İzole Çatal Bir Ağız Anahtar 13 mm / Single Ended Open Jaw Wrench Super Insulated	1	
0255 01 0014	Süper İzole Çatal Bir Ağız Anahtar 14 mm / Single Ended Open Jaw Wrench Super Insulated	1	
0255 01 0017	Süper İzole Çatal Bir Ağız Anahtar 17 mm / Single Ended Open Jaw Wrench Super Insulated	1	
0255 01 0019	Süper İzole Çatal Bir Ağız Anahtar 19 mm / Single Ended Open Jaw Wrench Super Insulated	1	
0255 01 0022	Süper İzole Çatal Bir Ağız Anahtar 22 mm / Single Ended Open Jaw Wrench Super Insulated	1	
0255 01 0024	Süper İzole Çatal Bir Ağız Anahtar 24 mm / Single Ended Open Jaw Wrench Super Insulated	1	
0435 03 0010	Süper İzoleli Bir Ağız Yıldız Anahtar 10 mm / Single Ended Ring Wrench Super Insulated	1	
0435 03 0011	Süper İzoleli Bir Ağız Yıldız Anahtar 11 mm / Single Ended Ring Wrench Super Insulated	1	
0435 03 0012	Süper İzoleli Bir Ağız Yıldız Anahtar 12 mm / Single Ended Ring Wrench Super Insulated	1	
0435 03 0013	Süper İzoleli Bir Ağız Yıldız Anahtar 13 mm / Single Ended Ring Wrench Super Insulated	1	
0435 03 0014	Süper İzoleli Bir Ağız Yıldız Anahtar 14 mm / Single Ended Ring Wrench Super Insulated	1	
0435 03 0017	Süper İzoleli Bir Ağız Yıldız Anahtar 17 mm / Single Ended Ring Wrench Super Insulated	1	
0435 03 0019	Süper İzoleli Bir Ağız Yıldız Anahtar 19 mm / Single Ended Ring Wrench Super Insulated	1	
0435 03 0022	Süper İzoleli Bir Ağız Yıldız Anahtar 22 mm / Single Ended Ring Wrench Super Insulated	1	
0435 03 0024	Süper İzoleli Bir Ağız Yıldız Anahtar 24 mm / Single Ended Ring Wrench Super Insulated	1	



2. Elektro Seri Çekmece/Drawer Kod / Code 13000 005569

KOD/CODE	İÇERİK CONTENTS	☐	TL/Ad.
13000 005148	1000V 1/2" Altı Köşe Lokma Anahtar 10 mm / Socket Wrech 6 Points	1	14.065,75
13000 005149	1000V 1/2" Altı Köşe Lokma Anahtar 11 mm / Socket Wrech 6 Points	1	
13000 005150	1000V 1/2" Altı Köşe Lokma Anahtar 12 mm / Socket Wrech 6 Points	1	
13000 005151	1000V 1/2" Altı Köşe Lokma Anahtar 13 mm / Socket Wrech 6 Points	1	
13000 005152	1000V 1/2" Altı Köşe Lokma Anahtar 14 mm / Socket Wrech 6 Points	1	
13000 005153	1000V 1/2" Altı Köşe Lokma Anahtar 15 mm / Socket Wrech 6 Points	1	
13000 005154	1000V 1/2" Altı Köşe Lokma Anahtar 16 mm / Socket Wrech 6 Points	1	
13000 005155	1000V 1/2" Altı Köşe Lokma Anahtar 17 mm / Socket Wrech 6 Points	1	
13000 005156	1000V 1/2" Altı Köşe Lokma Anahtar 19 mm / Socket Wrech 6 Points	1	
13000 005157	1000V 1/2" Altı Köşe Lokma Anahtar 22 mm / Socket Wrech 6 Points	1	
13000 005158	1000V 1/2" Altı Köşe Lokma Anahtar 24 mm / Socket Wrech 6 Points	1	
13000 005159	1000V 1/2" Altı Köşe Lokma Anahtar 27 mm / Socket Wrech 6 Points	1	
13000 005277	1000V 1/2" Cırcır Kol 36 Diş / Ratchet Handle	1	
13000 005262	1000V 1/2" Ara Kol 75 mm / Extension Bar	1	
13000 005264	1000V 1/2" Ara Kol 250 mm / Extension Bar	1	
13000 005541	1000V 1/2" İzoleli T Kol / Sliding T-Handle	1	



3. Elektro Seri Çekmece/Drawer Kod / Code 13000 005570

KOD/CODE	İÇERİK CONTENTS	☐	TL/Ad.
2400 11 6240	1000V İzoleli Üniversal Fort Pense 240 mm Insulated Type Waterpump Pliers Universal	1	7.492,25
3020 12 6160	1000V İzoleli Elektrikçi Kombine Pense 160 mm Insulated Electrician Type Combination Pliers	1	
3220 13 6180	1000V İzoleli Elektrikçi Düz Kargaburun 180 mm Insulated Electrician Type Nose Pliers	1	
3700 16 6160	1000V İzoleli Elektrikçi Yan Keski 160 mm Insulated Electrician Type Side Cutter	1	
3715 16 6165	1000V İzoleli Tek Ağızlı Kablo Kesici 165 mm Insulated Cable Cutter	1	
13000 005519	1000V İzoleli Elektrikçi Çok Fonksiyonlu Pense 200 mm Insulated Electrician Type Multi Function Spring Wrench	1	
0600 01 0010	1000V İzoleli Kurbağacık Anahtar 10" Insulated Electrician Type Adjustable Wrench	1	
03753 50 026	1000V İzoleli Elektrikçi Mekanik Kablo Sıyırıcı 0.2-6mm Insulated Mechanical Cable Stripper	1	



4. Elektro Seri Çekmece/Drawer Kod / Code 13000 005571

KOD CODE	İÇERİK CONTENTS	☐	TL/Ad.
4140 17 2575	1000V İzoleli Elektrikçi Düz Uç Tornavida 2.5x75 / Insulated Electrician Type Flat Screwdriver	1	6.723,25
4140 17 4100	1000V İzoleli Elektrikçi Düz Uç Tornavida 4x100 / Insulated Electrician Type Flat Screwdriver	1	
4140 17 5512	1000V İzoleli Elektrikçi Düz Uç Tornavida 5.5x125 / Insulated Electrician Type Flat Screwdriver	1	
4140 17 6515	1000V İzoleli Elektrikçi Düz Uç Tornavida 6.5x150 / Insulated Electrician Type Flat Screwdriver	1	
4145 18 0360	1000V İzoleli Elektrikçi Yıldız Uç Tornavida 3x60 / Insulated Electrician Type Phillips Screwdriver	1	
4145 18 4580	1000V İzoleli Elektrikçi Yıldız Uç Tornavida 4.5x80 / Insulated Electrician Type Phillips Screwdriver	1	
4145 18 6100	1000V İzoleli Elektrikçi Yıldız Uç Tornavida 6x100 / Insulated Electrician Type Phillips Screwdriver	1	
4773 19 0040	1000V Sığıştırmalı İzoleli Lokma Uçlu Tornavida 4mm / Insulated Electrician Type Nut Spinner	1	
4773 19 0050	1000V Sığıştırmalı İzoleli Lokma Uçlu Tornavida 5 mm / Insulated Electrician Type Nut Spinner	1	
4773 19 0055	1000V Sığıştırmalı İzoleli Lokma Uçlu Tornavida 5.5 mm / Insulated Electrician Type Nut Spinner	1	
4773 19 0060	1000V Sığıştırmalı İzoleli Lokma Uçlu Tornavida 6 mm / Insulated Electrician Type Nut Spinner	1	
4773 19 0070	1000V Sığıştırmalı İzoleli Lokma Uçlu Tornavida 7 mm / Insulated Electrician Type Nut Spinner	1	
4773 19 0080	1000V Sığıştırmalı İzoleli Lokma Uçlu Tornavida 8 mm / Insulated Electrician Type Nut Spinner	1	
4773 19 0090	1000V Sığıştırmalı İzoleli Lokma Uçlu Tornavida 9 mm / Insulated Electrician Type Nut Spinner	1	
4773 19 0100	1000V Sığıştırmalı İzoleli Lokma Uçlu Tornavida 10 mm / Insulated Electrician Type Nut Spinner	1	
4773 19 0110	1000V Sığıştırmalı İzoleli Lokma Uçlu Tornavida 11 mm / Insulated Electrician Type Nut Spinner	1	
4773 19 0120	1000V Sığıştırmalı İzoleli Lokma Uçlu Tornavida 12 mm / Insulated Electrician Type Nut Spinner	1	
4773 19 0130	1000V Sığıştırmalı İzoleli Lokma Uçlu Tornavida 13 mm / Insulated Electrician Type Nut Spinner	1	
4773 19 0140	1000V Sığıştırmalı İzoleli Lokma Uçlu Tornavida 14 mm / Insulated Electrician Type Nut Spinner	1	
4783 19 6120	1000V Sığıştırmalı İzoleli Manyetik Bits Tutucu Tornavida 6.3x120 / Insulated Magnetic Bit Holder	1	
4800 00 8131	31'li Bits Takım (Plastik Kutulu) / Bit Set in Plastic Case	31	



Garaj Serisi Takım Dolabı (5-6-7-8 Çekmeceli)
 Garage Series Workshop Trolley (5-6-7-8 Drawers)

- ✓ Ergonomik sap
- Ergonomic handle



- ✓ 9 Bölmeli, sağlam ABS tabla
- 9 durable ABS worktop with divisions



- ✓ Havluluk x1
- Avadanlık x2
- Askılık x1
- Paper Roll Holder x1
- Bottle & Tins Holder x2
- Hanger x1



- ✓ %100 açılabilir teleskobik raylar
- %100 extendable telescopic slides



- ✓ Merkezi kilit sistemi, mandal sistemi devrilme emniyet sistemi
- Central locking, system handgrip lock system antitilt system



- ✓ 2 sabit, 2 hareketli frenli tekerlek Ø 125mm
- 2 swivel castors with brake 2 fixed castors Ø 125 mm



- ✓ Yüksek dayanımlı elektrostatik toz boya
- High strength electrostatic powder coating



Ölçü/Size: 470x670x1010 mm

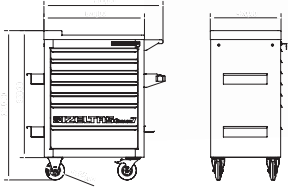

Sacdan imal edilmiş, Fırın boya

Made of sheet metal, Electrostatic paint

 RAL 9005 GOF
 RAL 3020 GOF

 RAL 9005 GOF
 RAL 5003 GOF

 RAL 9005 GOF
 RAL 7035 GOF

KOD/CODE	ÇEKMECE DRAWERS				Kg	RENK COLORS	TL/Ad
		400x548x68	400x548x143	400x548x218			
★ 8242 32 1005	5	1X	4X	--	59		19.070,00
★ 8242 32 1006	6	4X	1X	1X	62	RAL 9005 GOF	22.446,50
★ 8242 32 1007	7	5X	2X	--	65	RAL 3020 GOF	26.226,00
★ 8242 32 1008	8	7X	1X	--	67		28.790,25
★ 8242 32 2005	5	1X	4X	--	59		19.070,00
★ 8242 32 2006	6	4X	1X	1X	62	RAL 9005 GOF	22.446,50
★ 8242 32 2007	7	5X	2X	--	65	RAL 5003 GOF	26.226,00
★ 8242 32 2008	8	7X	1X	--	67		28.790,25
★ 8242 32 3005	5	1X	4X	--	59		19.070,00
★ 8242 32 3006	6	4X	1X	1X	62	RAL 9005 GOF	22.446,50
★ 8242 32 3007	7	5X	2X	--	65	RAL 7035 GOF	26.226,00
★ 8242 32 3008	8	7X	1X	--	67		28.790,25
★ 8242 00 1142	7	5X	2X	--			52.270,75
Dolu/Full 139 Parça/Pcs							
★ 8242 00 8142	8	7X	1X	--			54.835,00
Dolu/Full 139 Parça/Pcs							

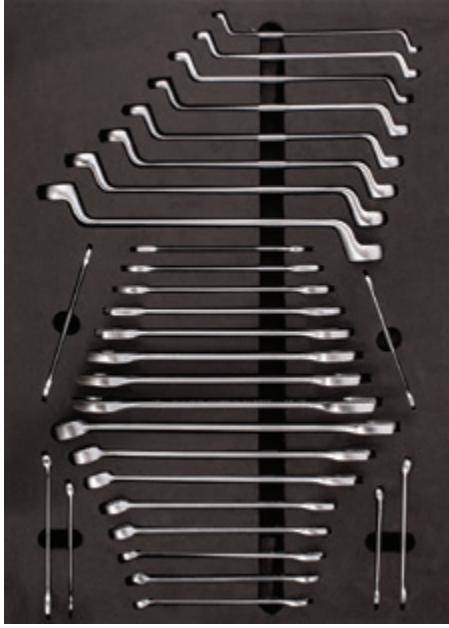

1. Garaj Seri Çekmece/Drawer Kod / Code 8242001030

KOD CODE	İÇERİK CONTENTS	☐	TL/Ad
0130	İki Ağız Anahtar Uzun Boy D/E Open Jaw Wrench Long Pattern 6x7 - 8x9 - 10x11 - 12x13 14x15 - 16x17 - 18x19 - 20x22 - 21x23 - 24x26	10	
0330	Kombine Anahtar Uzun Boy Combination Wrenches Long Pattern 6 - 7 - 8 - 9 - 10 - 11 - 12 - 13 - 14 - 17 - 19 - 22	12	4.543,00
0430	Yıldız Anahtar Ring Wrench 6x7 - 8x9 - 10x11 - 12x13 - 14x15 - 16x17 - 18x19 - 20x22	8	

2. Garaj Seri Çekmece/Drawer Kod / Code 8242002072

KOD CODE	İÇERİK CONTENTS	☐	TL/Ad
1113	1/2" Lokmalı Allen Uçlar Hexagonal Bits Socket H5-H6-H7-H8-H10-H12-H14	7	
1113	1/2" Lokmalı Star Uç / 1/2 Star Bits Socket T20-T25-T27-T30-T40-T45-T50-T55-T60	9	
0330	Kombine Anahtar Uzun Boy Combination Pliers Long 16-18	2	
4900	Allen Takımı Altı Köşe / Hex Key Wrench Set 2-2.5-3-3.5-4-5-6-7-8-9-10-12	12	
1107	1/4" Altı Köşe Lokma Takımı Socket Wrench Set 4 - 5 - 6 7 - 8 - 9 - 10 11 - 12 - 13 Altı Köşe Six Points 1/4" Cırcır Kolu Ratchet Handle 1/4" Mafsal Universal Joint 1/4" T Kol / Sliding T Handle 1/4" Ara Kol / Extension Bar 50 -100 mm	15	9.054,00
1113	1/2" Lokma Takımı Socket Wrench Set 10 - 11 - 12 13 - 14 - 15 16 - 17 - 18 19 - 21 - 22 23 - 24 - 26 27 - 28 - 30 32 Altı Köşe Six Points 1/2" Cırcır Kolu 32 Diş Ratchet Handle 1/2" Mafsal Universal Joint 1/2" T Kol Adaptör Sliding T Handle Adapter 1/2" Ara Kol Extension Bar 125-250 mm	24	





3. Garaj Seri Çekmece/Drawer

Kod / Code 8242003010

KOD CODE	İÇERİK CONTENTS		TL/Ad
3331	İç Eğri Segman Pense Circlip Pliers Internal (Bent) 170 mm	1	
3321	İç Düz Segman Pense Circlip Pliers Internal (Flat) 180 mm	1	
3311	Dış Eğri Segman Pense Circlip Pliers External (Bent) 170 mm	1	
3301	Dış Düz Segman Pense Circlip Pliers External (Flat) 180 mm	1	
3700	Yan Keski Opak Seri Side Cutting Pliers 160 mm	1	6.190,75
3220	Düz Kargaburun Opak Seri Nose Pliers (Flat) 200 mm	1	
3020	Kombine Pense Opak Seri Combination Pliers 180 mm	1	
2510	Ayarlı Pense / Special 250 mm	1	
0600	Kurbağacık Anahtar / Adjustable Wrench 10"	1	
2400	Üniversal Fort Pense / Waterpump Pliers Üniversal 240 mm	1	



4. Garaj Seri Çekmece/Drawer

Kod / Code 8242004018

KOD CODE	İÇERİK CONTENTS		TL/Ad
4300	Opak Seri Düz Uçlu Tornavida Screwdriver, Opak Flat 4x100-5x125-6x150-8x175	4	
4320	Opak Seri Yıldız Uçlu Tornavida Screwdriver, Opak Phillips 4.5x80-6x100	2	
5800	Tesviyeci Çekiç Machinist's Hammer 300 gr	1	
5850	Plastik Çekiç Plastic Hammer ø30	1	3.491,00
5545	Konik Pim Zimba Drift Punch 5 mm	1	
5550	Düz Pim Zimba Split Pin Punch 5 mm	1	
5540	Nokta Zimba Center Punch 5x120	1	
5500	Düz Keski Flat Cold Chisel 150 mm	1	
4920	T Tipi Allen Anahtar / Hex Key Wrench 3-4-5-6-7-8	6	



5. Garaj Seri Çekmece/Drawer

Kod / Code 8242005011

KOD CODE	İÇERİK CONTENTS		TL/Ad
07415	Sıralı Tel Fırça 3 Sıralı Hand Brush 3 Raws	1	
6350	Levye Oluklu Tyre Lever, Straight 400 mm	1	
6220	Spiralli Mıknatıs Flexible Magnet Holder 500 gr	1	
4110	Düz Topaç Tornavida Screwdriver Stubby Flat 6.5x25	1	2.766,00
4130	Yıldız Topaç Tornavida Screwdriver Stubby Phillips 6x25	1	
4770	Lokma Uçlu Tornavida Nut Spinner 6-7-8-9-10-13	6	



ELITE SERİSİ / ELITE SERIES

Elite Serisi Takım Dolabı (7 Çekmeceli) Elite Series Workshop Trolley (7 Drawers)

**YENİ
NEW**



- ✓ Ergonomik sap
- Ergonomic handle



- ✓ 9 Bölmeli, sağlam ABS tabla
- 9 durable ABS worktop with divisions



- ✓ Havluluk x1
- Avadanlık x2 Askılık x1
- Paper Roll Holder x1
- Bottle & Tins Holder x2 Hanger x1



- ✓ %100 açılabilir teleskobik raylar
- %100 extendable telescopic slides



- ✓ Merkezi kilit sistemi, mandal sistemi devrilme emniyet sistemi
- Central locking, system handgrip lock system antitilt system



- ✓ 2 sabit, 2 hareketli frenli tekerlek Ø 125mm
- 2 swivel castors with brake 2 fixed castors Ø 125 mm



- ✓ Yüksek dayanımlı elektrostatik toz boya
- High strength electrostatic powder coating





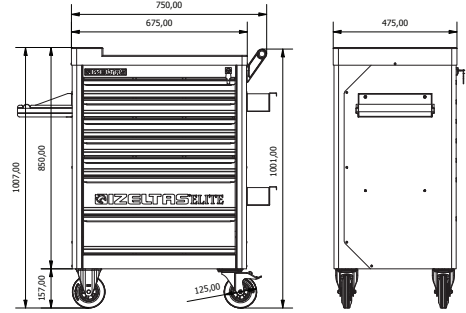

- ✓ Devrilme Emniyet Sistemli %100 Açılabilir Teleskopik Rulmanlı Ray
- 100% Extendable Telescopic Ball Bearing Rail with Tipping Safety System
- ✓ Merkezi Kilit Mandal Sistemi
- Central Lock System And Handgrip Lock System
- ✓ 1 Adet 4 Bölmeli Sağlam ve Dayanıklı ABS Üst Tabla
- 1 Piece 4 Compartment Sturdy and Durable ABS Top Table
- ✓ 2 Adet Avadanlık
- 2 Pieces of Handyman
- ✓ 1 Adet Havluluk
- 1 Piece Towel Holder
- ✓ 1 Adet Alüminyum Tutma Sapı
- 1 Piece Aluminum Handle
- ✓ 2 Sabit, 2 Hareketli, Frenli Tekerlek ø125 mm
- 2 Fixed, 2 Movable Castors with Brake ø125 mm



Ölçü/Size: 475x675x1007 mm

Sacdan imal edilmiş, Fırın boya
Made of sheet metal, Electrostatic paint

KOD/CODE	ÇEKMECE DRAWERS					RENK COLORS	TL/Ad
13000 005563	7	400x548x68	400x548x143	400x548x218	61	RAL 9005 G0F	21.255,00
13000 005572	7	5X	2X	-	-	RAL 3020 G0F	47.299,75
Dolu/Full 139 Parça/Pcs							

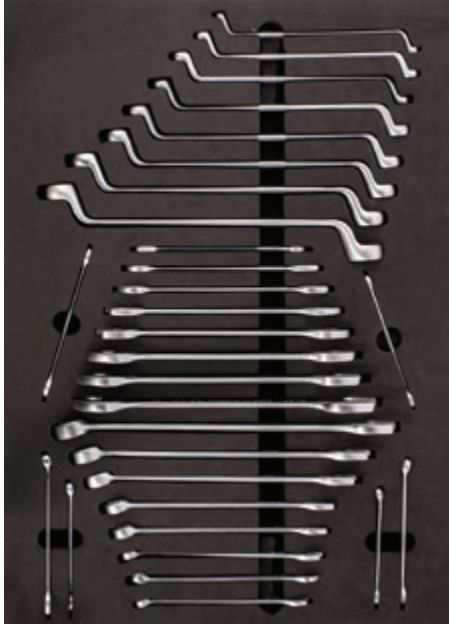

1. Elite Seri Çekmece/Drawer

Kod / Code 13000 005573

KOD CODE	İÇERİK CONTENTS	☐	TL/Ad
0130	İki Ağız Anahtar Uzun Boy D/E Open Jaw Wrench Long Pattern 6x7 - 8x9 - 10x11 - 12x13 14x15 - 16x17 - 18x19 - 20x22 - 21x23 - 24x26	10	
0330	Kombine Anahtar Uzun Boy Combination Wrenches Long Pattern 6 - 7 - 8 - 9 - 10 - 11 - 12 - 13 - 14 - 17 - 19 - 22	12	4.543,00
0430	Yıldız Anahtar Ring Wrench 6x7 - 8x9 - 10x11 - 12x13 - 14x15 - 16x17 - 18x19 - 20x22	8	

2. Elite Seri Çekmece/Drawer

Kod / Code 13000 005574



KOD CODE	İÇERİK CONTENTS	☐	TL/Ad
1113	1/2" Lokmalı Allen Uçlar Hexagonal Bits Socket H5-H6-H7-H8-H10-H12-H14	7	
1113	1/2" Lokmalı Star Uç / 1/2 Star Bits Socket T20-T25-T27-T30-T40-T45-T50-T55-T60	9	
0330	Kombine Anahtar Uzun Boy Combination Pliers Long 16-18	2	
4900	Allen Takımı Altı Köşe / Hex Key Wrench Set 2-2.5-3-3.5-4-5-6-7-8-9-10-12	12	
1107	1/4" Altı Köşe Lokma Takımı Socket Wrench Set 4 - 5 - 6 7 - 8 - 9 - 10 11 - 12 - 13 Altı Köşe Six Points 1/4" Cırcır Kolu Ratchet Handle 1/4" Mafsal Universal Joint 1/4" T Kol / Sliding T Handle 1/4" Ara Kol / Extension Bar 50 -100 mm	15	9.054,00
1113	1/2" Lokma Takımı Socket Wrench Set 10 - 11 - 12 13 - 14 - 15 16 - 17 - 18 19 - 21 - 22 23 - 24 - 26 27 - 28 - 30 32 Altı Köşe Six Points 1/2" Cırcır Kolu 32 Diş Ratchet Handle 1/2" Mafsal Universal Joint 1/2" T Kol Adaptör Sliding T Handle Adapter 1/2" Ara Kol Extension Bar 125-250 mm	24	



3. Elite Seri Çekmece/Drawer

Kod / Code 13000 005575

KOD CODE	İÇERİK CONTENTS		TL/Ad
3331	İç Eğri Segman Pense Circlip Pliers Internal (Bent) 170 mm	1	
3321	İç Düz Segman Pense Circlip Pliers Internal (Flat) 180 mm	1	
3311	Dış Eğri Segman Pense Circlip Pliers External (Bent) 170 mm	1	
3301	Dış Düz Segman Pense Circlip Pliers External (Flat) 180 mm	1	
3700	Yan Keski Opak Seri Side Cutting Pliers 160 mm	1	6.190,75
3220	Düz Kargaburun Opak Seri Nose Pliers (Flat) 200 mm	1	
3020	Kombine Pense Opak Seri Combination Pliers 180 mm	1	
2510	Ayarlı Pense / Special 250 mm	1	
0600	Kurbağacık Anahtar / Adjustable Wrench 10"	1	
2400	Üniversal Fort Pense / Waterpump Pliers Üniversal 240 mm	1	



4. Elite Seri Çekmece/Drawer

Kod / Code 13000 005576

KOD CODE	İÇERİK CONTENTS		TL/Ad
4300	Opak Seri Düz Uçlu Tornavida Screwdriver, Opak Flat 4x100-5x125-6x150-8x175	4	
4320	Opak Seri Yıldız Uçlu Tornavida Screwdriver, Opak Philips 4.5x80-6x100	2	
5800	Tesviyeci Çekiç Machinist's Hammer 300 gr	1	
5850	Plastik Çekiç Plastic Hammer ø30	1	3.491,00
5545	Konik Pim Zimba Drift Punch 5 mm	1	
5550	Düz Pim Zimba Split Pin Punch 5 mm	1	
5540	Nokta Zimba Center Punch 5x120	1	
5500	Düz Keski Flat Cold Chisel 150 mm	1	
4920	T Tipi Allen Anahtar / Hex Key Wrench 3-4-5-6-7-8	6	



5. Elite Seri Çekmece/Drawer

Kod / Code 13000 005577

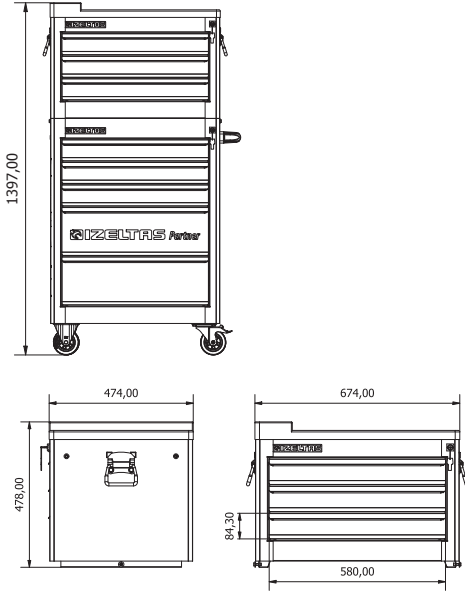

KOD CODE	İÇERİK CONTENTS		TL/Ad
07415	Sıralı Tel Fırça 3 Sıralı Hand Brush 3 Raws	1	
6350	Levyeye Oluklu Tyre Lever, Straight 400 mm	1	
6220	Spiralli Miknatis Flexible Magnet Holder 500 gr	1	
4110	Düz Topaç Tornavida Screwdriver Stubby Flat 6.5x25	1	2.766,00
4130	Yıldız Topaç Tornavida Screwdriver Stubby Phillips 6x25	1	
4770	Lokma Uçlu Tornavida Nut Spinner 6-7-8-9-10-13	6	

Partner Seri 3 Çekmeceli Dolap Üstü Dolap
Partner Series Workshop Trolley Top Unit With 3 Drawers

- ✓ Standart Tırnaklı %100 Açılabilir Teleskopik Ray
- Telescopic Slides Which Are %100 Extendable
- ✓ Merkezi Kilit Mandal Sistemi
- Central Lock System And Handgrip Lock System
- ✓ 1 Adet 9 Bölmeli Sağlam ve Dayanıklı ABS Üst Tabla
- Durable ABS Worktop With 9 Divisions

Ölçü/Size: 474x674x478 mm

Sacdan imal edilmiş, Fırın boya
Made of sheet metal, Electrostatic paint

KOD/CODE	ÇEKMECE DRAWERS	 3.5 kg	 Kg	RENK COLORS	TL/Ad
13000 005561	3	400x548x74	32.40	RAL 3020 GOF	11.515,00

Partner Mobil Takım Dolabı (5 Çekmeceli)
Partner Workshop Trolley (5 Drawers)



- ✓ Merkezi kilit sistemi ve mandal sistemi
- Central lock system and handgrip lock system



- ✓ Teleskobik rulmanlı kızaklar tüm çekmeceler %100 açılabilir
- Telescopic slides which are %100 extendable.



- ✓ 9 Bölmeli, sağlam ABS tabla
- 9 Durable ABS worktop with divisions



- ✓ 2 sabit, 2 hareketli frenli tekerlek ø 100mm
- 2 swivel castors with brake 2 fixed castors ø 100 mm

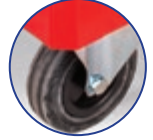

- ✓ Yüksek dayanımlı elektrostatik toz boya.
- High strength electrostatic powder coating



İZELTAS YOUTUBE

Ölçü/Size: 470x670x975 mm

Sacdan imal edilmiş, Fırın boya
Made of sheet metal, Electrostatic paint

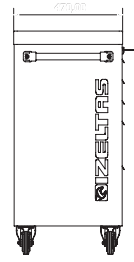
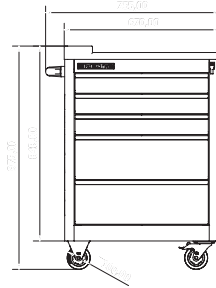



RAL 3020 GOF



RAL 5003 GOF



RAL 9005 GOF

KOD/CODE	ÇEKMECE DRAWERS			Kg	RENK COLORS	TL/Ad
		397x549x74	397x549x182			
8235 32 6005	5	3X	2X	56	RAL 3020 GOF	17.350,00
8235 32 5005	5	3X	2X	56	RAL 5003 GOF	17.350,00
8235 32 7005	5	3X	2X	56	RAL 9005 GOF	17.350,00
8235 00 6121 Dolu/Full 118 Parça/Pcs	5	3X	2X			36.471,50

1. Partner Seri Çekmece/Drawer
Kod / Code 8235001072

KOD CODE	İÇERİK CONTENTS	TL/Ad
1107	<p>1/4" Altı Köşe Lokma Takımı 1/4" Socket Wrench Set</p> <p>1/4" Cırcır kolu Ratchet Handle</p> <p>4 - 5 - 6 7 - 8 - 9 - 10 11 - 12 - 13 Altı Köşe Six Points</p> <p>1/4" Mafsal Universal Joint</p> <p>1/4" T Kol Sliding T Handle</p> <p>1/4" Ara Kol Extention Bar 50-100 mm</p> <p>1/2" Lokma Takımı 1/2" Socket Set</p> <p>1/2" Cırcır Kolu 32 Diş Ratchet Handle</p> <p>10 - 11 - 12 13 - 14 - 15 16 - 17 - 18 19 - 21 - 22 23 - 24 - 26 27 - 28 - 30 - 32</p> <p>1/2" Mafsal Universal Joint</p> <p>1/2" T Kol Adaptör Sliding T Handle Adapter</p> <p>1/2" Ara Kol Extention Bar 125-250 mm</p> <p>1/4" Derin Lokma Tornavida Adaptörü Spindle Handle</p> <p>12'li Allen Anahtar Takımı Hex Key Wrench Set 2-2.5-3-3.5-4-5-6-7-8-9-10-12 mm</p> <p>8'li Torx Allen Anahtar Takımı Torx Key Wrench T9-T10-T15-T20-T25-T27-T30-T40</p> <p>1/2" Altı Köşe Derin Lokma Deep Socket Wrench 6 Point 10-13-16-17-18-19 mm</p> <p>1/2" 16 mm Buji Lokma Anahtar Spark Plug Socket With Rubber</p> <p>240 mm Üniversal Fort Pense Waterpump Pliers, Universal</p> <p>250 mm Üniversal Ayarlı Pense Universal Grip</p>	<p>15</p> <p>24</p> <p>1</p> <p>12</p> <p>8</p> <p>6</p> <p>1</p> <p>1</p> <p>1</p> <p>10.194,50</p>



2. Partner Seri Çekmece/Drawer

Kod / Code 8235002031

KOD CODE	İÇERİK CONTENTS	☐	TL/Ad
0100	İki Ağız Anahtar Kısa Boy Double Ended Open Jaw Wrench Short Pattern 6x7 - 8x9 - 10x11 - 12x13 14x15 - 16x17 - 18x19 - 20x22 21x23 - 24x26 - 25x28 - 30x32	12	
0320	Kombine Anahtar Kısa Boy Combination Wrench Short Pattern 8 - 9 - 10 - 11 - 12 - 13 14 - 15 - 16 - 17 - 19 - 22	12	4.526,00
0430	Yıldız Anahtar Ring Wrench 8x9 - 10x11 - 12x13 - 14x15 - 16x17 18x19 - 20x22	7	



3. Partner Seri Çekmece/Drawer

Kod / Code 8235003017

KOD CODE	İÇERİK CONTENTS	☐	TL/Ad
4300	Opak Seri Düz Uçlu Tornavida Screwdriver, Opak Flat 3x80-4x80-4x100-5x125-6x150	5	
4320	Opak Seri Yıldız Uçlu Tornavida Screwdriver, Opak Philips 4.5x80-6x100	2	
3700	Yan Keski Opak Seri Side Cutting Pliers 160 mm	1	
3020	Kombine Pense Opak Seri Combination Pliers 180 mm	1	4.401,00
3220	Düz Kargaburun Opak Seri Nose Pliers Flat 200 mm	1	
4770	Lokma Uçlu Tornavida Nut Spinner 6-7-8-10-13	5	
5500	Düz Keski Flat Cold Chisel 150 mm	1	
5800	Tesviyeci Çekiçi Machinist's Hammer 500 gr	1	



Eko Serisi Takım Dolabı (3-5-7 Çekmeceli) Eco Series Workshop Trolley (3-5-7 Drawers)



Ölçü/Size: 410x620x894 mm

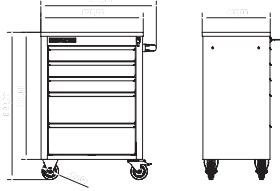

İZELTAS YOUTUBE

Sacdan imal edilmiş, Fırın boya
Made of sheet metal, Electrostatic paint



✓ Merkezi kilit
● Central locking



✓ %100 açılabilir teleskobik raylar
● %100 extendable telescopic slides



✓ Yüksek dayanımlı elektrostatik toz boya
● High strength electrostatic powder coating

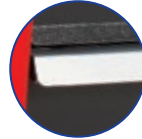

✓ Elokсалlı alüminyum tutma çantası
● Handle with anodised aluminum



✓ 2 sabit, 2 hareketli frenli tekerlek ø 100 mm
● 2 fixed castors with brake 2 swivel castors ø 100 mm

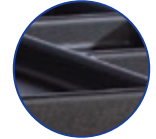

✓ 4 bölümlü sağlam ve dayanıklı ABS plastik üst malzeme tabla
● Resistant and solid top cover with 4 divisions

KOD/CODE	ÇEKMECE DRAWERS	35 kg	35 kg	DEMONTE RAF DISASSEMBLED SHELF	Kg	RENK COLORS	TL/Ad
		350x503x82	350x503x176				
★ 8243 32 1003	3	3X	--	2	44.1	RAL 9005 60F	12.657,00
★ 8243 32 1005	5	3X	2X	--	46.1	RAL 3020 60F	12.657,00
★ 8243 32 1007	7	7X	--	--	51.9		16.968,25
★ 8243 32 2005	5	3X	2X	--	46.1	RAL 9005 60F	12.657,00
★ 8243 32 2007	7	7X	--	--	51.9	RAL 5003 60F	16.968,25
★ 8243 32 3005	5	3X	2X	--	46.1	RAL 7035 60F	12.657,00
★ 8243 32 3007	7	7X	--	--	51.9	RAL 9005 60F	16.968,25
★ 8243 00 1096	5	3X	2X	--		RAL 9005 60F	27.954,25
★ 8243 00 7096	7	7X	--	--		RAL 3020 60F	32.265,50
Dolu/Full 93 Parça/Pcs							
Dolu/Full 93 Parça/Pcs							

★ Stoklarla Sınırlıdır / It is Limited by Stocks.

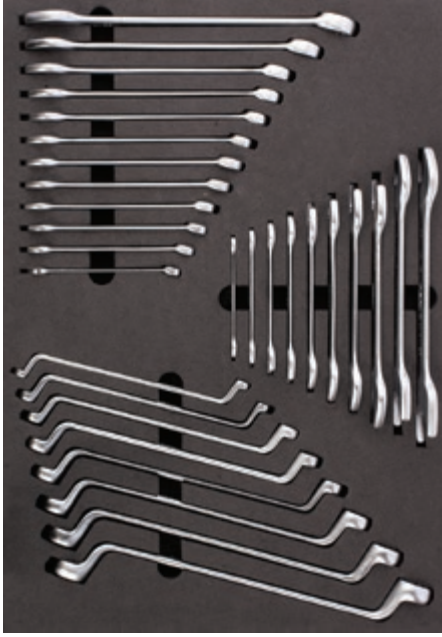

1. Eko Seri Çekmece/Drawer Kod / Code 8243001030

KOD/CODE	İÇERİK CONTENTS	☐	TL/Ad.
0100	İki Ağız Anahtar Kısa Boy D/E Open Jaw Wrench Short Pattern 6x7 - 8x9 - 10x11 - 12x13 14x15 - 16x17 - 18x19 - 20x22 - 21x23 - 24x26	10	
0320	Kombine Anahtar Kısa Boy Combination Wrench Short Pattern 8 - 9 - 10 - 11 - 12 - 13 - 14 - 15 - 16 - 17 - 19 - 22	12	4.271,00
0430	Yıldız Anahtar Ring Wrench 6x7 - 8x9 - 10x11 - 12x13 - 14x15 - 16x17 18x19 - 20x22	8	



2. Eko Seri Çekmece/Drawer Kod / Code 8243002052

KOD/CODE	İÇERİK CONTENTS	☐	TL/Ad.
1113	1/2" 17'li Lokma Takımı Socket Wrench Set 1/2" mm 10 - 11 - 12 - 13 - 14 - 15 - 17 - 19 22 - 24 - 27 - 30 - 32 250 - 250 - 70	17	
1107	1/4" Altı Köşe Lokma Takımı Socket Wrench Set 1/4" mm 4 - 5 - 6 - 7 - 8 - 9 - 10 - 11 - 12 - 13 140 - 115 - 100 - 50 - 38	15	6.471,50
4900	Allen Anahtar Takımı Hex Key Wrench Set 2 - 2.5 - 3 - 3.5 - 4 - 5 - 6 - 7 - 8 - 9 - 10 - 12	12	
4770	Lokma Uçlu Tornavidalar Nutspinners 6 - 7 - 8 - 10 - 13	5	



3. Eko Seri Çekmece/Drawer Kod / Code 8243003013

KOD/CODE	İÇERİK CONTENTS	☐	TL/Ad.
4320	Opak Seri Yıldız Uçlu Tornavida Opak Screwdriver, Phillips 4,5x80-6x100	2	
4300	Opak Seri Düz Uçlu Tornavida Opak Screwdriver, Flat 4x100-5x125-6x150-8x175	4	
3700	Yan Keski Opak Seri Side Cutting Pliers 160 mm	1	
3020	Kombine Pense Opak Seri Combination Pliers 180 mm	1	
3220	Kargaburun Düz Uçlu Opak Seri Nose Pliers, Flat 160 mm	1	4.554,75
5500	Düz Keski Krom Flat Cold Chisel 150 mm	1	
5800	Tesviyeci Çekici Machinist's Hammer 300 gr	1	
2510	Spesiyal Ayarlı Pense / Special Grip 250 mm	1	
2400	Üniversal Fort Pense / Waterpump Pliers Universal 240 mm	1	

★ Stoklarla Sınırlıdır / It is Limited by Stocks.

Trend Serisi Takım Dolabı (5-7 Çekmeceli)

Trend Series Workshop Trolley (5-7 Drawers)



✓ 4 bölmeli sağlam ve dayanıklı
ABS plastik üst malzeme tabla
● Resistant and solid
top cover with 4 divisions



✓ %100 açılabilir
teleskobik raylar
● %100 extendable
telescopic slides



✓ Merkezi kilit
● Central locking



✓ 2 sabit, 2 hareketli
frenli tekerlek ø 100 mm
● 2 swivel castors with brake
2 fixed castors ø 100 mm



✓ Yüksek dayanımlı
elektrostatik toz boya
● High strength electrostatic
powder coating

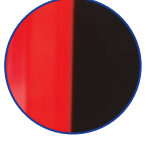

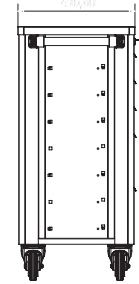
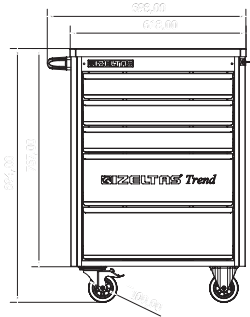

Ölçü/Size: 410x618x894 mm



İZELTAS YOUTUBE

Sacdan imal edilmiş, Fırın boya
Made of sheet metal, Electrostatic paint

KOD/CODE	ÇEKMECE DRAWERS	 350x503x82	 350x503x176	 Kg	RENK COLORS	TL/Ad
13000 005562	3	3X	--	38.2		12.455,00
8244 32 1005	5	3X	2X	40.7		12.707,50
8244 32 1007	7	7X	--	44.4		13.231,50
8244 00 5096 Dolu/Full 93 Parça/Pcs	5	3X	2X		RAL 9005 GOF RAL 3020 GOF	28.004,75
8244 00 7096 Dolu/Full 93 Parça/Pcs	7	7X	--			28.528,75

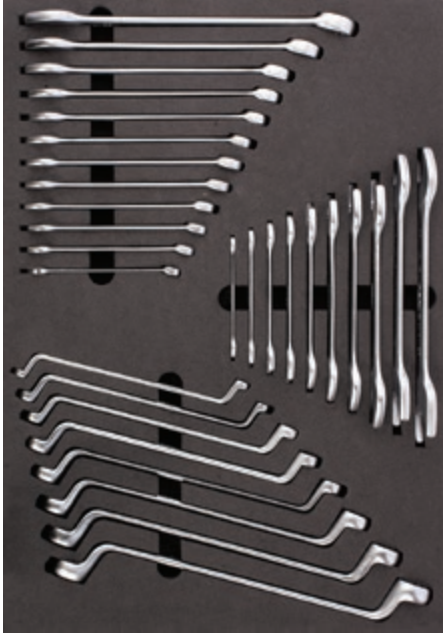

1. Trend Seri Çekmece/Drawer Kod / Code 8244001030

KOD/CODE	İÇERİK CONTENTS		TL/Ad.
0100	İki Ağız Anahtar Kısa Boy D/E Open Jaw Wrench Short Pattern 8x7 - 8x9 - 10x11 - 12x13 14x15 - 16x17 - 18x19 - 20x22 - 21x23 - 24x26	10	
0320	Kombine Anahtar Kısa Boy Combination Wrench Short Pattern 8 - 9 - 10 - 11 - 12 - 13 - 14 - 15 - 16 - 17 - 19 - 22	12	4.271,00
0430	Yıldız Anahtar Ring Wrench 6x7 - 8x9 - 10x11 - 12x13 - 14x15 - 16x17 18x19 - 20x22	8	



2. Trend Seri Çekmece/Drawer Kod / Code 8244002052

KOD/CODE	İÇERİK CONTENTS		TL/Ad.
1113	1/2" 17'li Lokma Takımı Socket Wrench Set 1/2" mm 10 - 11 - 12 - 13 - 14 - 15 - 17 - 19 22 - 24 - 27 - 30 - 32 250 - 250 - 70	17	
1107	1/4" Altı Köşe Lokma Takımı Socket Wrench Set 1/4" mm 4 - 5 - 6 - 7 - 8 - 9 - 10 - 11 - 12 - 13 140 - 115 - 100 - 50 - 38	15	6.471,50
4900	Allen Anahtar Takımı Hex Key Wrench Set 2 - 2.5 - 3 - 3.5 - 4 - 5 - 6 - 7 - 8 - 9 - 10 - 12	12	
4770	Lokma Uçlu Tornavidalar Nutspinners 6 - 7 - 8 - 10 - 13	5	



3. Trend Seri Çekmece/Drawer Kod / Code 8244003013

KOD/CODE	İÇERİK CONTENTS		TL/Ad.
4320	Opak Seri Yıldız Uçlu Tornavida Opak Screwdriver, Phillips 4.5x80-6x100	2	
4300	Opak Seri Düz Uçlu Tornavida Opak Screwdriver, Flat 4x100-5x125-6x150-8x175	4	
3700	Yan Keski Opak Seri Side Cutting Pliers 180 mm	1	
3020	Kombine Pense Opak Seri Combination Pliers 180 mm	1	4.554,75
3220	Kargaburun Düz Uçlu Opak Seri Nose Pliers, Flat 180 mm	1	
5500	Düz Keski Krom Flat Cold Chisel 150 mm	1	
5800	Tesviyeci Çekici Machinist Hammer 300 gr	1	
2510	Special Ayarlı Pense / Special Grip 250 mm	1	
2400	Üniversal Fort Pense / Waterpump Pliers Universal 240 mm	1	

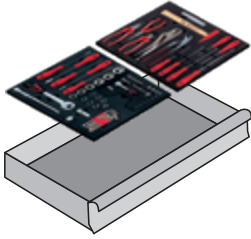
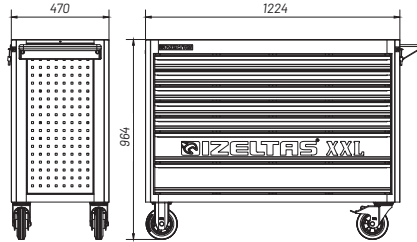
Takım Dolabı Ahşap Üst Tablalı XXL (7 Çekmeceli)
XXL Series Workshop Trolley (7 Drawers)

Ölçü/Size: 470x1224x964 mm

Aşağıda yazılı olan muhteviyatlı süngerlerden her bir çekmeceye İKİ (2) adet yerleştirilebilir.

- | | |
|--------------------------------|-------------------------|
| 1. Premium Seri Çekmece/Drawer | Kod / Code 8245001042 |
| 2. Premium Seri Çekmece/Drawer | Kod / Code 8245002094 |
| 3. Premium Seri Çekmece/Drawer | Kod / Code 8245003014 |
| 4. Premium Seri Çekmece/Drawer | Kod / Code 8245004043 |
| 5. Premium Seri Çekmece/Drawer | Kod / Code 8245005043 |
| 6. Premium Seri Çekmece/Drawer | Kod / Code 8245006009 |
| 1. Pro Seri Çekmece/Drawer | Kod / Code 8241001030 |
| 2. Pro Seri Çekmece/Drawer | Kod / Code 8241002072 |
| 3. Pro Seri Çekmece/Drawer | Kod / Code 8241003051 |
| 4. Pro Seri Çekmece/Drawer | Kod / Code 8241004027 |
| 5. Pro Seri Çekmece/Drawer | Kod / Code 8241005010 |
| 6. Pro Seri Çekmece/Drawer | Kod / Code 8241006018 |
| 1. Elite Seri Çekmece/Drawer | Kod / Code 13000 005573 |
| 2. Elite Seri Çekmece/Drawer | Kod / Code 13000 005574 |
| 3. Elite Seri Çekmece/Drawer | Kod / Code 13000 005575 |
| 4. Elite Seri Çekmece/Drawer | Kod / Code 13000 005576 |
| 5. Elite Seri Çekmece/Drawer | Kod / Code 13000 005577 |
| 1. Partner Seri Çekmece/Drawer | Kod / Code 8235001072 |
| 2. Partner Seri Çekmece/Drawer | Kod / Code 8235002031 |
| 3. Partner Seri Çekmece/Drawer | Kod / Code 8235003017 |

- ✓ 18mm masif üst tabla
- 18 mm solid wood top



- ✓ %100 açılabilir teleskobik raylar
- %100 extendable telescopic slides



- ✓ Merkezi kilit
- ✓ Mandal sistemi
- ✓ Devrilme emniyet sistemi
- Central lock
- Handgrip Lock system
- Anti tilt system



- ✓ Ergonomik sap
- Ergonomic handle





- ✓ 2 sabit, 2 hareketli frenli tekerlek ø 150mm
- 2 swivel castors with brake
- 2 fixed castors ø 150mm

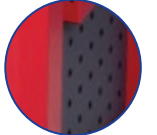

- ✓ Yüksek dayanımlı elektrostatik toz boya
- High strength electrostatic powder coating.



Sacdan imal edilmiş, Fırın boya
 Made of sheet metal, Electrostatic paint

KOD/CODE	ÇEKMECE DRAWERS				RENK COLORS	TL/Ad
		1098x400x60	1098x400x135			

8246 32 1007

7

5X

2X

125.7

RAL 9005 GOF

RAL 3020 GOF

31.815,50

8247 32 1007

Takım Dolabı Ahşap Üst Tablalı Workbench (7 Çekmeceli)
Workbench Series Workshop Trolley (7 Drawers)

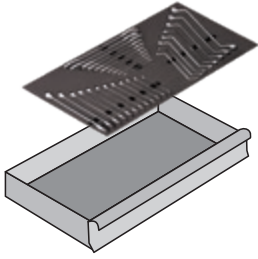

Ölçü/Size: 500x1150x991 mm

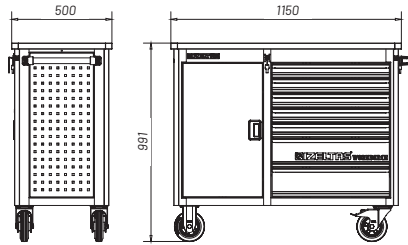

Aşağıda yazılı olan muhteşiyatlı süngerlerden her bir çekmeceye BİR (1) adet yerleştirilebilir.

- | | |
|--------------------------------|-------------------------|
| 1. Premium Seri Çekmece/Drawer | Kod / Code 8245001042 |
| 2. Premium Seri Çekmece/Drawer | Kod / Code 8245002094 |
| 3. Premium Seri Çekmece/Drawer | Kod / Code 8245003014 |
| 4. Premium Seri Çekmece/Drawer | Kod / Code 8245004043 |
| 5. Premium Seri Çekmece/Drawer | Kod / Code 8245005043 |
| 6. Premium Seri Çekmece/Drawer | Kod / Code 8245006009 |
| 1. Pro Seri Çekmece/Drawer | Kod / Code 8241001030 |
| 2. Pro Seri Çekmece/Drawer | Kod / Code 8241002072 |
| 3. Pro Seri Çekmece/Drawer | Kod / Code 8241003051 |
| 4. Pro Seri Çekmece/Drawer | Kod / Code 8241004027 |
| 5. Pro Seri Çekmece/Drawer | Kod / Code 8241005010 |
| 6. Pro Seri Çekmece/Drawer | Kod / Code 8241006018 |
| 1. Elite Seri Çekmece/Drawer | Kod / Code 13000 005573 |
| 2. Elite Seri Çekmece/Drawer | Kod / Code 13000 005574 |
| 3. Elite Seri Çekmece/Drawer | Kod / Code 13000 005575 |
| 4. Elite Seri Çekmece/Drawer | Kod / Code 13000 005576 |
| 5. Elite Seri Çekmece/Drawer | Kod / Code 13000 005577 |
| 1. Partner Seri Çekmece/Drawer | Kod / Code 8235001072 |
| 2. Partner Seri Çekmece/Drawer | Kod / Code 8235002031 |
| 3. Partner Seri Çekmece/Drawer | Kod / Code 8235003017 |

- ✓ 30 mm masif ahşap üst tabla
- 30 mm solid wood top

- ✓ %100 açılabilir teleskobik raylar
- %100 extendable telescopic slides

- ✓ Merkezi kilit
- ✓ Mandal sistemi
- ✓ Devrilme emniyet sistemi
- Central lock
- Handgrip Lock system
- Anti tilt system



- ✓ Standard tutma sapı
- Standard handle

- ✓ 2 sabit, 2 hareketli frenli tekerlek ø 150mm
- 2 swivel castors with brake 2 fixed castors ø 150mm

- ✓ Yüksek dayanımlı elektrostatik toz boya
- High strength electrostatic powder coating

- ✓ 4 kısa, 2 uzun seperetör
- 4 Short, 2 long separators

Sacdan imal edilmiş, Fırın boya
Made of sheet metal, Electrostatic paint

KOD/CODE	ÇEKMECE DRAWERS				RENK COLORS	TL/Ad
		400x548x60	400x548x134			

8247 32 1007

7

5X

2X

102.7

RAL 9005 GOF

RAL 3020 GOF

29.857,00



Premium

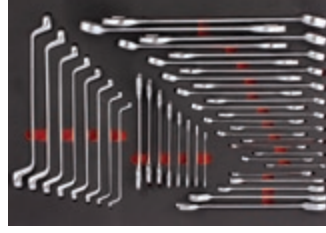
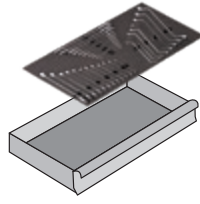

Premium Seri Çekmece 1
Kod / Code 8245001042
Sayfa 14



Pro

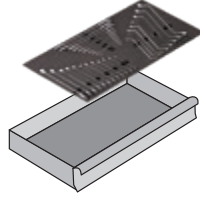

Premium Seri Çekmece 2
Kod / Code 8245002094
Sayfa 14



Elite

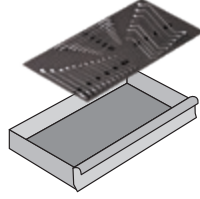

Premium Seri Çekmece 3
Kod / Code 8245003014
Sayfa 14



Partner

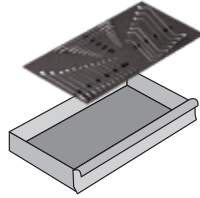

Premium Seri Çekmece 4
Kod / Code 8245004043
Sayfa 15



Workbench

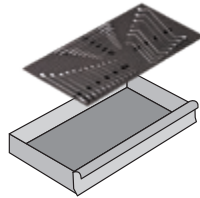

Premium Seri Çekmece 5
Kod / Code 8245005043
Sayfa 15



XXL

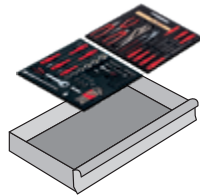

Premium Seri Çekmece 6
Kod / Code 8245006009
Sayfa 15

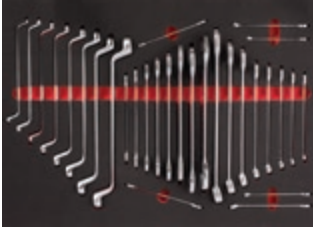

Pro Seri Çekmece 1
Kod / Code 8241001030
Sayfa 18



Elite Seri Çekmece 1
Kod / Code 13000 005573
Sayfa 30



Pro Seri Çekmece 2
Kod / Code 8241002072
Sayfa 18



Elite Seri Çekmece 2
Kod / Code 13000 005574
Sayfa 30



Pro Seri Çekmece 3
Kod / Code 8241003051
Sayfa 18



Elite Seri Çekmece 3
Kod / Code 13000 005575
Sayfa 31



Pro Seri Çekmece 4
Kod / Code 8241004027
Sayfa 19



Elite Seri Çekmece 4
Kod / Code 13000 005576
Sayfa 31



Pro Seri Çekmece 5
Kod / Code 8241005010
Sayfa 19



Elite Seri Çekmece 5
Kod / Code 13000 005577
Sayfa 31



Pro Seri Çekmece 6
Kod / Code 8241006018
Sayfa 19

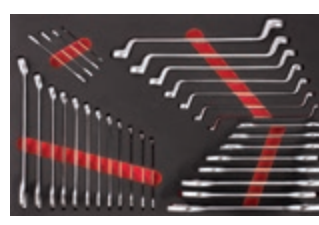

Partner Seri Çekmece 2
Kod / Code 8235002031
Sayfa 35



Partner Seri Çekmece 1
Kod / Code 8235001072
Sayfa 34



Partner Seri Çekmece 3
Kod / Code 8235003017
Sayfa 35



Grand Master Çekmece 1 - Sol
Kod / Code 13000 005590
Sayfa 7

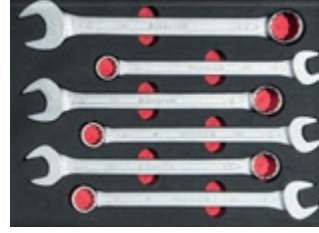

Grand Master Çekmece 1 - Sağ
Kod / Code 13000 005589
Sayfa 7

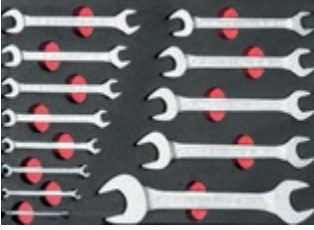

Grand Master Çekmece 2 - Sol
Kod / Code 13000 005591
Sayfa 7



Grand Master Çekmece 2 - Sağ
Kod / Code 13000 005592
Sayfa 7



Grand Master Çekmece 3 - Sol
Kod / Code 13000 005594
Sayfa 8



Grand Master Çekmece 3 - Sağ
Kod / Code 13000 005593
Sayfa 8



Grand Master Çekmece 4 - Sol
Kod / Code 13000 005595
Sayfa 9



Grand Master Çekmece 4 - Sağ
Kod / Code 13000 005596
Sayfa 9



Grand Master Çekmece 5 - Sol
Kod / Code 13000 005598
Sayfa 10



Grand Master Çekmece 5 - Sağ
Kod / Code 13000 005597
Sayfa 10



Grand Master Çekmece 6 - Sol
Kod / Code 13000 005600
Sayfa 11



Grand Master Çekmece 6 - Sağ
Kod / Code 13000 005599
Sayfa 11



Vagon Serisi Takım Dolabı
Wagon Series Workshop Trolley

Ölçü/Size: 474x670x1020 mm

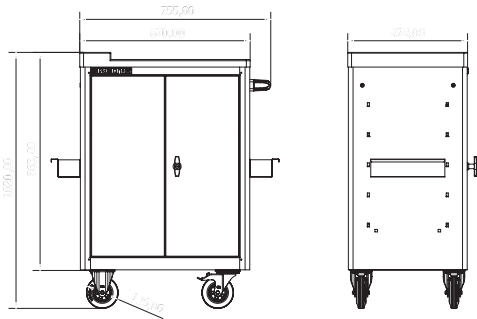

- ✓ 9 Bölmeli, sağlam ABS tabla
- Durable ABS worktop with divisions



- ✓ Kilit T Kol
- Locked T-handle



- ✓ 2 Sabit, 2 hareketli frenli tekerlek ø 125mm
- 2 swivel castors with brake 2 fixed castors ø 125 mm



- ✓ Yüksek dayanımlı elektrostatik toz boya.
- High strength electrostatic powder coating



- ✓ 2X ayarlanabilir raf (10 adet seperatör ile)
- 2x adaptable shelves with seperator 10 pcs



- ✓ Standard tutma sapı
- Standard handle

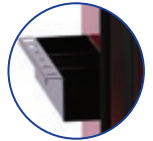

- ✓ 2X avadanlık
- 2X tin holder

**Sacdan imal edilmiş, Fırın boya**
Made of sheet metal, Electrostatic paint

KOD/CODE	Ölçü / SIZE (mm)	Kg	RENK COLORS	TL/Ad.
8210 32 6001	474x670x1020	45	RAL 9005 GOF RAL 3020 GOF	13.385,75

8160 32 6001

Takım Dolabı
Tool Cabinet



Ölçü/Size: 310x700x1050 mm

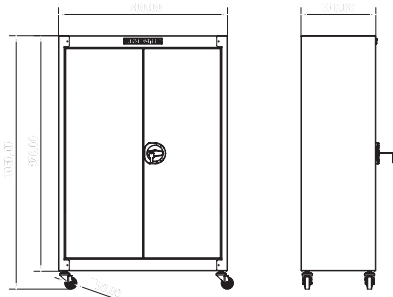

✓ Kollu kilit
● Locked T-handle



✓ %100 açılabilir teleskobik raylar
● %100 extendable telescopic slides



✓ 4 hareketli frenli tekerlek ø 50mm
● 4 swivel castors with brake ø 50 mm



✓ Yüksek dayanımlı elektrostatik toz boya
● High strength electrostatic powder coating



✓ Avadanlık x2
● Bottle and tins holder x2



✓ Askılık x4
● Hanger x4



✓ Özel askılık x4
● Special hanger x4



✓ Anahtar askısı x1
● Hanger for wrenches x1

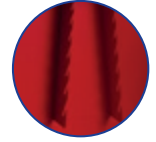

✓ Özel avadanlık x1
● Special tin holder x1



✓ Matkap ucu tutucu x1
● Drill bits holder x1



Sacdan imal edilmiş, Fırın boya
Made of sheet metal, Electrostatic paint

KOD/CODE		Ölçü / SIZE (mm)	 Kg	COLORS	TL/Ad.
	228x567x58				

8160 32 6001

3x

310x700x1050

35

RAL 9005 GOF

RAL 3020 GOF

12.072,50

Soyunma Dolabı Dar L 1800
Thin Locker

- ✓ 120° derece açılabilir kapak
- 120 degree openable cover
- ✓ 10 kg raf taşıma kapasitesi
- 10 kg shelf carrying capacity
- ✓ Tek kapaklı, 2 raflı, 3 bölmeli
- Single door, 2 shelves, 3 compartments
- ✓ Birinci kalite sağlam saç metal yapı
- Premium sheet metal construction
- ✓ Yüksek dayanımlı elektrostatik toz boya
- High strength electrostatic powder coating
- ✓ 4 adet kıyafet askısı
- 4 clothes hangers
- ✓ Asma kilit takılabilen kilit mekanizması
- Padlockable locking mechanism
- ✓ Kapak alt ve üst kısımlarda havalandırma ızgaraları
- Ventilation grilles
- ✓ Dolabın dengede durmasını sağlayan, zemini çizmeyen plastik pingo ayak
- Plastic leg that provide balance and do not scratch the floor
- ✓ Kapakları gizli menteşe
- Hidden hinge
- ✓ Yan yüzeylerde kullanılan destek saçları sayesinde darbeye karşı dayanıklılık
- Impact resistant support sheets used on the side surfaces
- ✓ Birbirine kolay montajlanabilir şekilde tasarlanmıştır.
- Easy to assemble together

RAL 9005 G0F

RAL 7035 G0F

Genişlik / Width 300 mm
Derinlik / Depth 400 mm
Yükseklik / Height 1800 mm

KOD/CODE	Ölçü / SIZE (mm)	Kg	TL/Ad.
13000 00 5399	300x400x1800	24.20	4.890,00

► Minimum sipariş adetlerine bağlı olarak renk seçenekleri mevcuttur.

Sacdan imal edilmiş, Fırın boya
Made of sheet metal, Electrostatic paint

13000 005400

Soyunma Dolabı Geniş L 1800
Wide Locker



- ✓ 120° derece açılabilir kapak
- 120 degree openable cover
- ✓ 10 kg raf taşıma kapasitesi
- 10 kg shelf carrying capacity
- ✓ Tek kapaklı, 2 raflı, 3 bölmeli
- Single door, 2 shelves, 3 compartments
- ✓ Birinci kalite sağlam saç metal yapı
- Premium sheet metal construction
- ✓ Yüksek dayanımlı elektrostatik toz boya
- High strength electrostatic powder coating
- ✓ 4 adet kıyafet askısı
- 4 clothes hangers
- ✓ Asma kilit takılabilen kilit mekanizması
- Padlockable locking mechanism
- ✓ Kapak alt ve üst kısımlarda havalandırma ızgaraları
- Ventilation grilles
- ✓ Dolabın dengede durmasını sağlayan, zemini çizmeyen plastik pingo ayak
- Plastic leg that provide balance and do not scratch the floor
- ✓ Kapakları gizli menteşe
- Hidden hinge
- ✓ Yan yüzeylerde kullanılan destek saçları sayesinde darbeye karşı dayanıklılık
- Impact resistant support sheets used on the side surfaces
- ✓ Birbirine kolay montajlanabilir şekilde tasarlanmıştır.
- Easy to assemble together

RAL 9005 G0F

Genişlik / Width 400 mm
Derinlik / Depth 400 mm
Yükseklik / Height 1800 mm

RAL 7035 G0F

KOD/CODE	Ölçü / SIZE (mm)	Kg	TL/Ad.
13000 00 5400	400x400x1800	26.20	5.950,00

Sacdan imal edilmiş, Fırın boya
Made of sheet metal, Electrostatic paint

► Minimum sipariş adetlerine bağlı olarak renk seçenekleri mevcuttur.

Soyunma Dolabı Orta Dar L 900
Medium Locker Thin**Soyunma Dolabı Orta Geniş L 900**
Medium Locker Wide

- ✓ 120° derece açılabilir kapak
- 120 degree openable cover
- ✓ 10 kg raf taşıma kapasitesi
- 10 kg shelf carrying capacity
- ✓ Tek kapaklı, 2 bölmeli
- Single door, 1 shelves, 2 compartments
- ✓ Birinci kalite sağlam saç metal yapı
- Premium sheet metal construction
- ✓ Yüksek dayanımlı elektrostatik toz boya
- High strength electrostatic powder coating

- ✓ Asma kilit takılabilen kilit mekanizması
- Padlockable locking mechanism
- ✓ Kapak alt ve üst kısımlarda havalandırma ızgaraları
- Ventilation grilles on up and down sides of the door
- ✓ Kapakları gizli menteşe
- Hidden hinge
- ✓ Birbirine kolay montajlanabilir şekilde tasarlanmıştır.
- Easy to assemble together

RAL 9005 G0F

RAL 7035 G0F

Genişlik / Width 300 mm
Derinlik / Depth 400 mm
Yükseklik / Height 900 mm

RAL 9005 G0F

RAL 7035 G0F

Genişlik / Width 400 mm
Derinlik / Depth 400 mm
Yükseklik / Height 900 mm

Sacdan imal edilmiş, Fırın boya
Made of sheet metal, Electrostatic paint

Sacdan imal edilmiş, Fırın boya
Made of sheet metal, Electrostatic paint

KOD/CODE	Ölçü / SIZE (mm)	Kg	TL/Ad.
13000 00 5566	300x400x900	12.5	2.935,00

KOD/CODE	Ölçü / SIZE (mm)	Kg	TL/Ad.
13000 00 5567	400x400x900	13.2	3.570,00

► Minimum sipariş adetlerine bağlı olarak renk seçenekleri mevcuttur.

13000 005564

Soyunma Dolabı Kısa Dar L 450
Cube Locker Thin



13000 005565

Soyunma Dolabı Kısa Geniş L 450
Cube Locker Wide



- ✓ 120° derece açılabilir kapak
- 120 degree openable cover
- ✓ Tek kapaklı, tek bölmeli
- Single door, 1 shelves
- ✓ Birinci kalite sağlam sac metal yapı
- Premium sheet metal construction
- ✓ Yüksek dayanımlı elektrostatik toz boya
- High strength electrostatic powder coating

- ✓ Asma kilit takılabilen kilit mekanizması
- Padlockable locking mechanism
- ✓ Kapak alt ve üst kısımlarda havalandırma ızgaraları
- Ventilation grilles on up and down sides of the door
- ✓ Kapakları gizli menteşe
- Hidden hinge
- ✓ Birbirine kolay montajlanabilir şekilde tasarlanmıştır.
- Easy to assemble together

RAL 9005 GOF
RAL 7035 GOF

Genişlik / Width 300 mm
Derinlik / Depth 400 mm
Yükseklik / Height 450 mm

RAL 9005 GOF
RAL 7035 GOF

Genişlik / Width 400 mm
Derinlik / Depth 400 mm
Yükseklik / Height 450 mm

Sacdan imal edilmiş, Fırın boya
Made of sheet metal, Electrostatic paint

Sacdan imal edilmiş, Fırın boya
Made of sheet metal, Electrostatic paint

KOD/CODE	Ölçü / SIZE (mm)	Kg	TL/Ad.
13000 00 5564	300x400x450	6.15	1.955,00

KOD/CODE	Ölçü / SIZE (mm)	Kg	TL/Ad.
13000 00 5565	400x400x450	7.10	2.380,00

► Minimum sipariş adetlerine bağlı olarak renk seçenekleri mevcuttur.

Çekmeceli Servis Arabası Service Trolley With Drawers



- 2X Çekmece, 35 kg Taşıma Kapasitesi
2X Drawers, 35 kg Loading Capacity
- Devrilme Emniyet Sistemli %100 Açılabilir Teleskopik Rulmanlı Yay
Telescopic Slides Which Are %100 extendable, handgrip lock system
- Merkezi Kilit Sistemi
Central lock system
- 3 Adet Kauçuk Kaydırmaz Mat, 10 Adet Seperatör
3X Rubber Anti Slipping Mats, 10 Separators
- 2 Sabit, 2 Hareketli, Frenli Tekerlek
2X Fixed, 2x Swivel Castors with Brake
- 1 Adet Demonte Raf
1X Demountable Shelf
- 2 Adet Sabit Raf, 50 kg Taşıma Kapasitesi
2X Fixed Shelf, loading capacity per shelf 50 kg

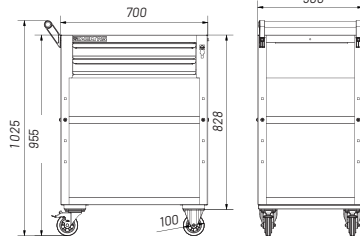

Çelik konstrüksiyon
Steel construction

KOD/CODE	Ölçü / SIZE (mm)	Kg	RENK COLORS	TL/Ad.
13000 005560	500x700x955	31.10	RAL 9005 GOF RAL 3020 GOF	11.510,00

8550

Demonte Mini Servis Arabası Disassembled Mini Service Trolley

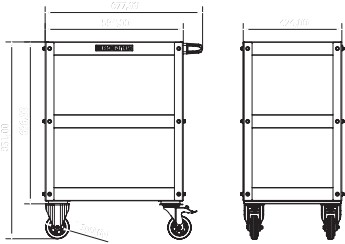

- 3X Kauçuk Kaydırmaz Mat
3X Rubber Anti Slipping Mats
- 2X Sabit, 2X Hareketli Frenli Tekerlek (ø 100 mm)
2X Fixed, 2X Swivel Castors with Brake (ø 100 mm)
- Sağlam sac metal yapı, Her raf 50 Kg taşır.
Robust sheet-steel construction, Loading capacity per shelf 50 Kg

Kapalı
8550 34 8002

Açık
8550 34 8001

Çelik konstrüksiyon
Steel construction

KOD/CODE	50 kg	Ölçü / SIZE (mm)	Kg	RENK COLORS	TL/Ad.
8550 34 8001	3X	424x594x851	18	RAL 9005 GOF RAL 3020 GOF	5.752,75
8550 34 8002	3X	424x594x851	23	RAL 9005 GOF RAL 3020 GOF	6.634,25

8545 34 1005

Taşıma Arabası
Platform Wagon

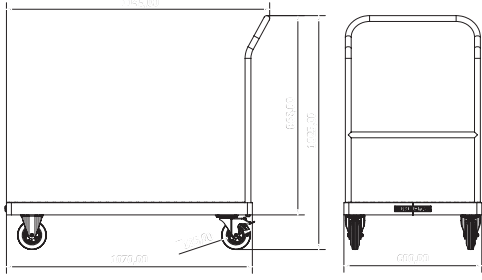

- 12mm PVC kaplı kontrplak Tabla
12mm PVC coated plywood
- 2X Sabit, 2X Hareketli Frenli Tekerlek (ø 125mm)
2X Fixed, 2X Swivel Castors with Brake (ø 125mm)
- Sağlam sac metal yapı, 310 Kg taşır.
Robust sheet-steel construction, Loading capacity per shelf 310 Kg

Çelik konstrüksiyon
Steel construction

KOD/CODE	Ölçü / SIZE (mm)	Kg	RENK COLORS	TL/Ad.
8545 34 1005	600x1145x1025	38	RAL 9005 GOF	17.428,25

8550 34 6001

Servis Arabası (Büyük Boy)
Service Trolley (Large Size)

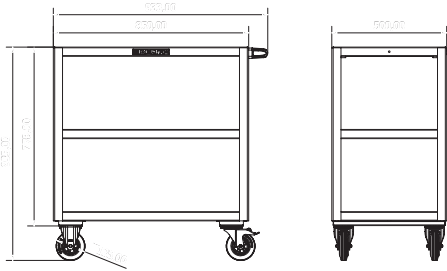

- 3X Kauçuk Kaydırmaz Mat
3X Rubber Anti Slipping Mats
- 2X Sabit, 2X Hareketli Frenli Tekerlek (ø 125 mm)
2X Fixed, 2X Swivel Castors with Brake (ø 125 mm)
- Sağlam sac metal yapı, Her raf 75 Kg taşır.
Robust sheet-steel construction, Loading capacity per shelf 75 Kg

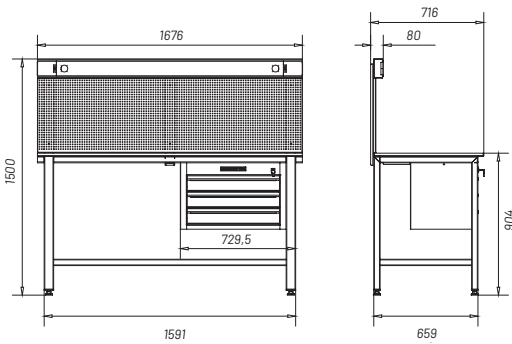

Çelik konstrüksiyon
Steel construction

KOD/CODE	Ölçü / SIZE (mm)	Kg	RENK COLORS	TL/Ad.
8550 34 6001	500x850x935	37	RAL 3020 GOF	9.553,50

Servis Masası (Panolu)
Work Bench (With Panel)

- **Merkezi kilit sistemi, mandal sistemi**
Central locking system, handgrip lock system
- **Kaynaklı sağlam tasarım**
Robust welded design
- **%100 Açılabilir teleskobik raylar**
100% extendable telescopic slides
- **Yüksek dayanımlı elektrostatik toz boya.**
High strength electrostatic powder paint
- **Delikli panel (220 V prizler ile).**
Perforated panel with electrical plugs 220 V

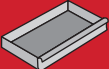
Çelik Konstrüksiyon ve zor koşullarda çalışmaya elverişli
Özel Plywood ahşap tezgah
Strong and durable steel construction and Plywood bench

KOD/CODE		Ölçü / SIZE (mm)	 Kg	RENK COLORS	TL/Ad.
8500 34 6001	3X	720x1680x1495	102	RAL 7016 GOF RAL 3020 GOF	23.900,75

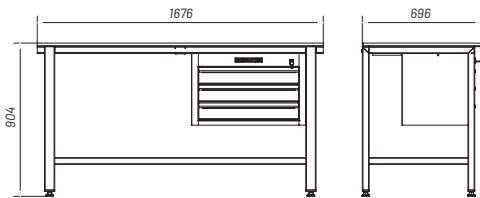

8501 34 6001

Servis Masası (Panosuz)
Work Bench (Without Panel)

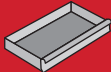

- **Merkezi kilit sistemi, mandal sistemi**
Central locking system, handgrip lock system
- **Kaynaklı sağlam tasarım**
Robust welded design
- **%100 Açılabilir teleskobik raylar**
100% extendable telescopic slides
- **Yüksek dayanımlı elektrostatik toz boya.**
High strength electrostatic powder paint

Çelik konstrüksiyon ve zor koşullarda çalışmaya elverişli
Özel Plywood ahşap tezgah
Strong and durable steel construction and Plywood bench

KOD/CODE		Ölçü / SIZE (mm)	 Kg	RENK COLORS	TL/Ad.
8501 34 6001	3X 348x548x90	700x1680x900	84	RAL 7016 GOF RAL 3020 GOF	18.096,25

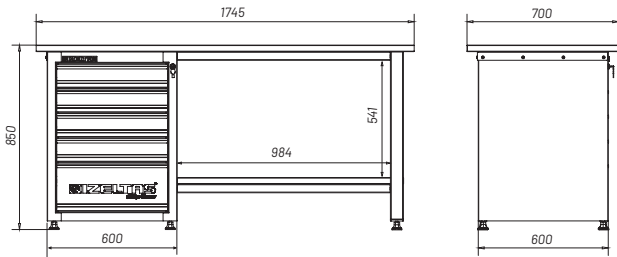
Demonte Atölye Masası
Disassembled Workbench

- ✓ %100 açılabilir teleskobik raylar.
- %100 extendable telescopic slides





- ✓ Merkezi kilit
- ✓ Mandal sistemi
- Central lock
- Handgrip Lock system



- Demonte sağlam tasarım
Robust disassembled design
- 30mm masif ahşap
30 mm solid wood
- Ayarlanabilir ayaklar
Height adjustable feet

**Çelik konstrüksiyon**
Steel construction



KOD/CODE	ÇEKMECE DRAWERS				RENK COLORS	TL/Ad
8502 34 6002	5	4X	1X		RAL 7016 GOF RAL 3020 GOF	61.101,75

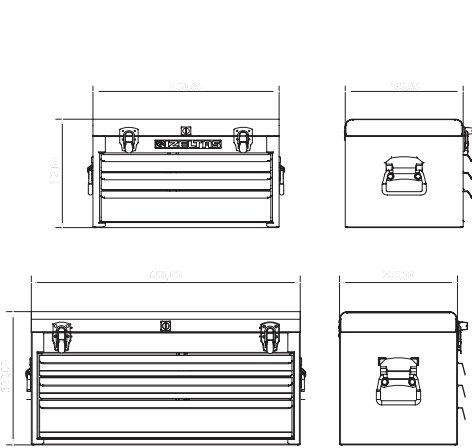

Çekmeceli Alet Sandığı
Tool Chest With Drawers

RAL 3020 G0F

Sacdan imal edilmiş, Fırın boya
Made from metal sheet, Electrostatic paint

KOD/CODE	Ölçü / SIZE (mm)	ÇEKMECE DRAWERS	 2x	 1x	 Kg	TL/Ad
8320 33 1001	285x450x322	3X	238x370x47	238x370x87	16	7.938,00
8320 33 1003	285x650x322	3X	238x570x47	238x570x87	20	8.686,00

8410

Takım Çantası (3 Gözlü)
Tool Box (3 Trays)

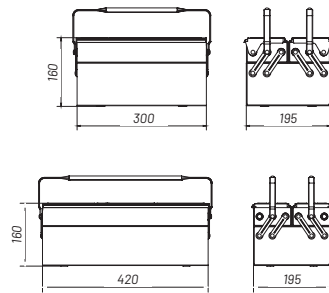

RAL 9005 GOF

RAL 3020 GOF

Sacdan imal edilmiş, Fırın boya
Made from metal sheet, Electrostatic paint

KOD CODE	Ölçü / SIZE (mm)	g	TL/Ad.
8410 33 6103	195x300x160	2400	1 1.012,50
8410 33 6203	195x420x160	3000	1 1.210,50

8420

Takım Çantası (5 Gözlü)
Tool Box (5 Trays)

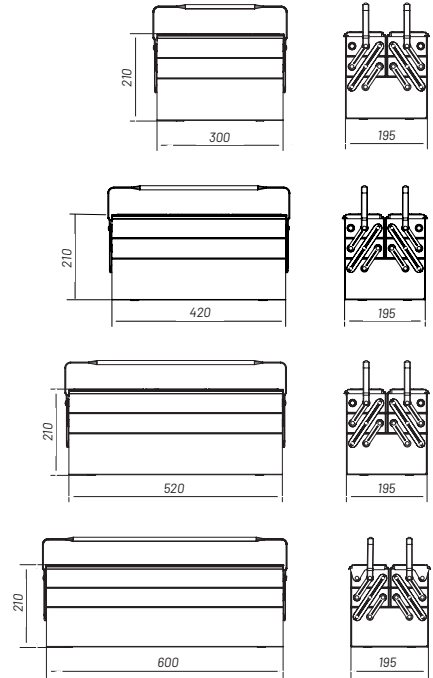

RAL 9005 GOF

RAL 3020 GOF

Sacdan imal edilmiş, Fırın boya
Made from metal sheet, Electrostatic paint

KOD CODE	Ölçü / SIZE (mm)	g	TL/Ad.
8420 33 6105	195x300x210	3200	1 1.782,00
8420 33 6205	195x420x210	4200	1 1.845,25
8420 33 6305	195x520x210	5000	1 2.144,50
8420 33 6405	195x600x210	5600	1 2.260,00

Takım Çantası (5 Gözlü)
Tool Box (5 Trays)**8420 00 5063**

Mekanikçi Takım Çantası (62 Parça, 5 Gözlü)
Tool Box for Mechanician (62 Pcs, 5 Trays)

**8420 00 5046**

Elektrikçi Takım Çantası (45 Parça, 5 Gözlü)
Tool Box for Electrician (45 Pcs, 5 Trays)

**8420 00 5028**

Tesisatçı Takım Çantası (28 Parça, 5 Gözlü)
Tool Box for Plumbers (28 Pcs, 5 Trays)



8420 00 5063

Mekanikçi Takım Çantası (5 Gözlü) Tool Box for Mechanician (5 Trays)

KOD CODE	ÖLÇÜ SIZE mm	TL/Ad.
8420 00 5063	195x420x210 DOLU / FULL	62 10.773,25

KOD CODE	İÇERİK CONTENTS	
05881 50 015	5 m Krom Şerit Metre Chrom Case Steel, Measuring tapes	1
4785 19 6330	6.3x30 Kısa Bits Tutucu Tornavida Screwdriver, Magnetic Bit Holder (Short)	1
4800 00 8110	10 'Lu Bits Takım Bits Set 10 (Pcs) 25 mm	10
4320	Opak Seri Yıldız Uçlu Tornavida Screwdriver, Opak, Flat 4.5x80-6x100	2
4300	Opak Seri Düz Uçlu Tornavida Screwdriver, Opak, Philips 3x80-4x100-5x125-6x150	4
4550 17 0135	135mm Kontrol Kalem Voltage Tester	1
2400 11 0240	240mm Üniversal Fort Pense Water Pump Pliers Universal	1
1113	1/2" Lokma Anahtar Socket Wrench 10-11-12-13-14-15-17 19-22-24-27-30-32	13
1513 06 4250	1/2" Uzun Ara Kol Extension Bar Long 250 mm	1
1513 06 4070	1/2" Mafsal Universal Joint 70 mm	1
1513 06 0032	1/2" Cırcır Kol 32 Dişli Ratchet Handle 250 mm	1
4900 00 3112	12 'Li Allen Anahtar Takım 6 Köşe Hex Key Wrench Set 2-2.5-3-3.5-4-5-6-7-8-9-10-12	12
0320	Kısa Kombine Anahtar Combination Wrench Short Pattern 8-9-10-11-12-13 14-17-19-22	10
3700 16 2160	160mm Yan Keski Opak Seri Side Cuting Nippers, Opak insulated	1
3020 12 2180	180mm Kombine Pense Opak Seri Combination Pliers, Opak Insulated	1
3220 13 2160	160mm Düz Kargaburun Opak Seri Nose Pliers, Flat, Opak Insulated	1

8420 00 5046

Elektrikçi Takım Çantası (5 Gözlü) Tool Box for Electrician (5 Trays)

KOD CODE	ÖLÇÜ SIZE mm	TL/Ad.
8420 00 5046	195x420x210 DOLU / FULL	45 12.291,50

KOD CODE	İÇERİK CONTENTS	
05881 50 005	5m Plastik Şerit Metre Plastic Measuring Tape	1
4783 19 6120	1000V İzoleli Manyetik Bits Tutucu Tornavida Screwdriver, Magnetic Bit Holder Insulated 6.3x120	1
4800 00 8106	6 'Lı Bits Takım Bits Set (6 Pcs)	6
0600 01 1010	10" Kurbağacık Anahtar Adjustable Jaw Wrench	1
4140-4145	1000V İzoleli Elektrikçi Düz, Yıldız Tornavida Insulated Electrician type Flat Screwdriver, Phillis 1000V 4x100-5.5x125 - 4.5x80-6x100	4
4550 17 0135	135mm Kontrol Kalem Voltage Tester	1
4550 17 0190	190mm Kontrol Kalem Voltage Tester	1
4773	1000V Süngüsü İzoleli Lokma Uçlu Tornavida Nut Spinner, Electrician Blode Insulated 1000V 6-7-8-10-13	5
0340	Cırcır Kombine Anahtar Combination Wrench With Ratchet 8-10-12-13-17-19	6
4900 00 3110	10 'Lu Allen Anahtar Takımı (mm) Hex Key Wrench Set 10 pcs 2-2.5-3-4-5-6-7-8-9-10	10
4500-4520	Klemens Tornavida Screwdriver, Electronic 3x80-3x100-3x125-3x60-4x80	5
3700 16 6160	1000V İzoleli Elektrikçi 160mm Yan Keski Insulated Electrician Type Side Cutter 1000V	1
3020 12 6180	1000V İzoleli Elektrikçi 180mm Kombine Pense Insulated Electrician Type Combination Plier 1000V	1
3220 13 6160	1000V İzoleli Elektrikçi 160mm Kargaburun Düz Insulated Electrician Type Nose Plier 1000V	1

8420 00 5028

Tesisatçı Takım Çantası (5 Gözlü) Tool Box for Plumbers (5 Trays)

KOD CODE	ÖLÇÜ SIZE mm	TL/Ad.
8420 00 5028	195x420x210 DOLU / FULL	28 10.601,00

KOD CODE	İÇERİK CONTENTS	
0600 01 1010	10" Kurbağacık Anahtar 10" Adjustable Wrench	1
0600 01 1012	12" Kurbağacık Anahtar 12" Adjustable Jaw Wrench PVC Insulated	1
2400 11 0240	240 Üniversal Fort Pense 240 Waterpump Pliers, Universal	1
2100 10 0012	12" Stilson Boru Anahtarı 12" Pipe Wrench, Stilson	1
4901 22 1270	1/2" Sae Allen Anahtar 1/2" Hex Key Wrench SAE	1
4300 17 6150	Opak Seri Düz Uçlu Tornavida Screwdriver, Opak, Slotted 6x150	1
4320 18 6100	Opak Seri Yıldız Uçlu Tornavida Screwdriver, Opak, Phillips 6x100	1
5800 25 0500	500gr Çekiç Machinist Hammer	1
5500 23 0200	200mm Düz Keski Flat Cold Chiesel	1
3830 15 0250	250mm Betoncu Kerpeten Tower Pincers	1
4900 00 3112	12 'Li Allen Anahtar Takımı (mm) Hex Key Wrench Set 12 pcs 2-2.5-3-3.5-4-5-6-7-8-9-10-12	12
0588 15 0015	5m Krom Şerit Metre Chrom Case Steel Measuring Tape	1
2201 10 0010	1" Maşalı Boru Anahtarı 1" Pipe Wrench	1
3700 16 2160	160mm Yan Keski Opak Seri Side Cutting Nippers, Opak insulated	1
3020 12 2180	180mm Kombine Pense Opak Seri Combination Pliers, Opak Insulated	1
3220 13 2160	160mm Düz Kargaburun Opak Seri Nose Pliers, Flat, Opak Insulated	1

8440

Plastik Takım Çantaları
Plastic Tool Boxes



KOD CODE	inch	ÖLÇÜ SIZE mm	g	TL/Ad.
8440 33 1016	16"	413x212x186	1207	4 532,25
8440 33 1019	19"	480x267x242	1922	4 744,75
8440 33 1022	22"	564x310x310	2870	4 1.219,75

8445 33 1028

Tekerlekli Plastik Takım Çantası
Plastic Mobile Tool Chest



KOD CODE	inch	ÖLÇÜ SIZE mm	g	TL/Ad.
8445 33 1028	28"	380x595x420	5900	1 2.939,75

8705 00 6113

Hobby Set Oto Tipi (13 Parça)
Hobby Set Auto Type (13 pcs)



KOD CODE	İÇERİK CONTENTS	TL/Ad.
0100	İki Ağız Anahtar (Kısa Boy) Duble Ended Open Jaw Wrench Short Pattern 8x9-10x11-12x13-14x15-16x17-18x19	6
1841	21 mm Kovan Anahtar Bir Ağız ve Mil Single Ended Tubular Socket Wench	1
2400	240 mm Üniversal Fort Pense Waterpump Pliers Universal	1
3020	160 mm Kombine Pense Opak Seri Combination Pliers	1
4240	Değişken Uçlu Tornavida Takımı Screwdriver Set Reversible 4.5x80 - 6x80	2
5800	200 gr Tesviyecici Çekiç / Machinist Hammer	1
6350	300 mm Levye Oluklu / Tyre Lever Straight	1

8790 00 8106

Bakım Onarım Seti (5 Parça)
Maintenance Set (5 Pcs)



KOD CODE	İÇERİK CONTENTS	TL/Ad.
3020 12 3160	160 mm Kombine Pense Kraft Seri Combination Pliers	1
3220 13 3160	160 mm Kargaburun Düz Uçlu Kraft Seri Nose Pliers Flat	1
3700 16 3140	140 mm Yan Keski Kraft Seri Side Cutting Pliers	1
4100 17 5100	5x100 Kraft Seri Düz Uçlu Tornavida Screwdriver Kraft, Flat	1
4120 18 4580	4.5x80 Kraft Seri Yıldız Uçlu Tornavida Screwdriver Kraft, Phillips	1

8793 00 1014
Bakım Seti (14 Parça)
Maintenance Set (14 Pcs)

KOD CODE	İÇERİK CONTENTS	☐	TL/Ad.
0100	İki Ağız Anahtar (Kısa Boy) Duble Ended Open Jaw Wrench Short Pattern 6x7-8x9-10x11-12x13-14x15-16x17-18x19-20x22	8	
3220 13 2160	160 mm Kargaburun Düz Uçlu Opak Seri Nose Pliers Flat	1	
3700 16 2140	140 mm Yan Keski Opak Seri Side Cutting Pliers	1	2.132,50
4300	4x100-6x100 Opak Seri Düz Uçlu Tornavida Screwdriver Kraft, Flat	2	
4320	4.5x80-6x100 Opak Seri Yıldız Uçlu Tornavida Screwdriver Kraft, Phillips	2	

8786 00 1003
Doğada Set (3 Parça)
Outdoor Set (3 Pcs)

 İZELTAŞ USTA İŞİ
 SOHBETLER

KOD CODE	İÇERİK CONTENTS	☐	TL/Ad.
6710 27 0230	Bağ Makası Lüks / Pruning Shears	1	
6735 27 0300	Dal Budama Testeresi / Pruning Saw	1	2.921,50
6410 25 0800	Nacak / Hatchet	1	

8779 00 8741
Motosiklet Bakım Seti (42 Parça)
Biker Set (42 Pcs)

KOD CODE	İÇERİK CONTENTS	☐	TL/Ad.
0100 01 0809	İki Ağız Anahtar Kısa Boy 08x09 Double Ended Open Jaw Wrench Short Pattern	1	
0100 01 1011	İki Ağız Anahtar Kısa Boy 10x11 Double Ended Open Jaw Wrench Short Pattern	1	
0100 01 1213	İki Ağız Anahtar Kısa Boy 12x13 Double Ended Open Jaw Wrench Short Pattern	1	
0100 01 1415	İki Ağız Anahtar Kısa Boy 14x15 Double Ended Open Jaw Wrench Short Pattern	1	
0100 01 1617	İki Ağız Anahtar Kısa Boy 16x17 Double Ended Open Jaw Wrench Short Pattern	1	
0600 01 1008	Kurbağacık Anahtar 8" Adjustable Wrench	1	
1107 06 0006	1/4" Altı Köşe 6 mm Lokma Anahtar Socket Wrench 6 Point	1	
1107 06 0008	1/4" Altı Köşe 8 mm Lokma Anahtar Socket Wrench 6 Point	1	
1107 06 0010	1/4" Altı Köşe 10 mm Lokma Anahtar Socket Wrench 6 Point	1	
1107 06 0011	1/4" Altı Köşe 11 mm Lokma Anahtar Socket Wrench 6 Point	1	
1107 06 0012	1/4" Altı Köşe 12 mm Lokma Anahtar Socket Wrench 6 Point	1	3.640,25
1107 06 0013	1/4" Altı Köşe 13 mm Lokma Anahtar Socket Wrench 6 Point	1	
1107 06 5010	1/4" Bits Tutucu Lokma Miknatıslı Bit Holder Socket	1	
4240 00 7102	Değişken Uçlu Tornavida Takımı Screwdriver Set Reversible	2	
4800 00 8106	6'lı Bits Set (25 mm) Bit Set 6 Pcs	6	
4900 00 3110	Allen Anahtar Takımı 10 Parça Hex Set Wrench Set (10 Pcs)	10	
4910 00 7108	Torx Allen Anahtar Takımı 8 Parça Torx Key Wrench Set (8 Pcs)	8	
1507 06 0050	1/4" Ara Kol 50 mm Extension Bar	1	
1507 06 2140	1/4"Cırcır Kolu 140 mm Ratchet Wrench	1	
1507 06 4080	1/4" Derin Tornavida Adaptörü Spindle Handle	1	

Farkını Gösteren Ustalara.

İZELTAS
BLACK LINE

**YENİ
NEW**



KOD : 13000 005133

KOD CODE	İÇERİK CONTENTS	☐	TL/Ad.
13000 005118	Kombine Pense 180 mm Combination Pliers 180 mm	1	2.892,25
13000 005117	Kargaburun Düz Uçlu 180 mm Long Nose Pliers Flat 180 mm	1	
13000 005119	Yan Keski 160 mm Side Cutter 160 mm	1	
13000 005116	Düz Uçlu Tornavida 6x100 Screwdriver Flat 6x100	1	
13000 005120	Yıldız Uçlu Tornavida 6x100 Screwdriver Philips 6x100	1	

13000 005538

Elektro Takım Çantası (24 Parça)
Electro Tool Bag (24 Pcs)



KOD CODE	İÇERİK CONTENTS		TL/Ad.
03752 50 625	Kablo Sıyırıcı Cable Stripper	1	15.120,25
05881 50 005	Plastik Şerit Metre Plastic Steel Case, Measuring tapes	1	
3020 12 6180	1000V İzoleli Elektrikçi Kombine Pense 180mm Insulated Electrician Type Combination Pliers 1000V	1	
3220 13 6180	1000V İzoleli Elektrikçi Kargaburun Düz Uçlu 180mm Insulated Electrician Type Nose Pliers 1000V	1	
3700 16 6160	1000V İzoleli Elektrikçi Yan Keski 160mm Insulated Electrician Type Side Cutter 1000V	1	
4140	1000V İzoleli Elektrikçi Düz Uçlu Tornavida Insulated Electrician Type Flat Screwdriver 1000V 2.5x75 - 4x100 - 5.5x125	3	
4145	1000V İzoleli Elektrikçi Yıldız Uçlu Tornavida Insulated Electrician Type Phillips Screwdriver 1000V 3x60 - 4.5x80 - 6x100	3	
4550 17 0190	Elektrik Kontrol Kalem 190mm (Düz Uçlu) Voltage Tester (Flat)	1	
13000 005263	1000V 1/2" Altı Köşe Lokma Anahtar (mm) Socket Wrench 6 Points 1000V (mm) 10 - 11 - 12 - 13 - 14 - 15 - 16 - 17 - 19	9	
13000 005277	1000V Ara Kol 125mm Extension Bar 1000V	1	
	1000V 1/2" Cırcır Kolu (32 Diş) Ratchet Handle 1000V (32 Teeth)	1	

14000 004136

Sırt Takım Çantası
Tool Backpack



Sırt Takım Çantası

- Su geçirmez, sağlam, dayanıklı ve uzun ömürlü, 600x600 imperteks kumaş
- Koruma sağlayıcı güçlendirilmiş sağlam plastik taban
- Maksimum düzeni sağlayan reflektörlü ön ve iç cepler
- Laptop bölmesi, sık kullanılan el aletleri için cepli çıkarılabilir ayraç
- Yumuşak pedli sırt desteği
- Yan mataralıklar

Tool Backpack

- Waterproof, solid, resistant and long-lasting 600X600 impertex fabric
- Protection provider, reinforced, solid plastic base
- Reflective front and interior pockets for maximum organization
- Laptop compartment, removable divider with pockets for frequently used tools
- Back support with soft pad
- Side bottle pockets

Bu çanta boş olarak satılmaktadır
This backpack is sold empty

KOD/CODE	Ölçü / SIZE (mm)	g	TL/Ad.
14000 004136	700x280x450	1385	1.859,25



Pro Sirt Takım Çantası

- Su geçirmez, sağlam, dayanıklı ve uzun ömürlü, 600x600 imperteks kumaş
- Koruma sağlayıcı güçlendirilmiş sağlam plastik taban
- Maksimum düzeni sağlayan reflektörlü fermuarlı cepler
- Laptop bölmesi, sık kullanılan el aletleri için cepli çıkarılabilir ayraç
- Yumuşak pedli sirt desteği
- Yan cepler



Pro Tool Backpack

- Waterproof, solid, resistant and long-lasting 600X600 impertex fabric
- Protection provider, reinforced, solid plastic base
- Reflective front and interior zip pockets for maximum organization
- Laptop compartment, removable divider with pockets for frequently used tools
- Back support with soft pad
- Side pockets

Bu çanta boş olarak satılmaktadır
This backpack is sold empty

KOD/CODE	Ölçü / SIZE (mm)	g	TL/Ad.
14000 005148	250x350x480	1220	3.115,50

14000 004133

Büyük Boy Bez Takım Çantası
Large Tool Bag



Büyük Boy Bez Takım Çantası

- Su geçirmez, sağlam, dayanıklı ve uzun ömürlü, 600x600 imperteks kumaş
- Koruma sağlayıcı güçlendirilmiş sağlam plastik taban
- Maksimum düzeni sağlayan reflektörlü ön cepler, çoklu arka ve iç cepler
- Özel el aleti bölmeli, geniş iç alan
- Ayarlanabilir omuz askısı ile kolay taşıma

Large Tool Bag

- Waterproof, solid, resistant and long-lasting 600X600 impertex fabric
- Protection provider, reinforced, solid plastic base
- Reflective front pockets with multiple back and interior pockets for maximum organization
- Wide interior space with special tool compartment
- Easy carrying with asjustable shoulder strap

Bu çanta boş olarak satılmaktadır
This toolbag is sold empty

KOD/CODE	Ölçü / SIZE (mm)	g	TL/Ad.
14000 004133	250x350x480	1220	1.697,75

14000 004135

Orta Boy Bez Takım Çantası
Medium Tool Bag



Orta Boy Bez Takım Çantası

- Su geçirmez, sağlam, dayanıklı ve uzun ömürlü, 600x600 imperteks kumaş
- Koruma sağlayıcı güçlendirilmiş sağlam plastik taban
- Maksimum düzeni sağlayan reflektörlü ön cepler, çoklu arka ve iç cepler
- Özel el aleti bölmeli, geniş iç alan
- Ayarlanabilir omuz askısı ile kolay taşıma

Medium Tool Bag

- Waterproof, solid, resistant and long-lasting 600X600 impertex fabric
- Protection provider, reinforced, solid plastic base
- Reflective front pockets with multiple back and interior pockets for maximum organization
- Wide interior space with special tool compartment
- Easy carrying with asjustable shoulder strap

Bu çanta boş olarak satılmaktadır
This toolbag is sold empty

KOD/CODE	Ölçü / SIZE (mm)	g	TL/Ad.
14000 004135	290x230x360	870	1.618,75

Çanta boş olarak satılmaktadır / Bag is sold empty

14000 004134

Küçük Boy Bez Takım Çantası
Small Tool Bag**Küçük Boy Bez Takım Çantası**

- Su geçirmez, sağlam, dayanıklı ve uzun ömürlü, 600x600 imperteks kumaş
- Kuvvetlendirilmiş taban
- Fermuarlı fileli ön cep
- Düğmeli arka cep
- Özel el aleti bölmeli, geniş iç alan
- Rahat taşımaya için deri elcik
- Yan reflektörler
- Özel metal fermuar başlığı

Small Tool Bag

- Waterproof, solid, resistant and long-lasting 600X600 impertex fabric
- Reinforced base
- Zippered front pocket
- Buttoned back pocket
- Wide interior space with special tool compartment
- Leather grips for comfortable carrying
- Side reflectors

KOD/CODE	Ölçü / SIZE (mm)	g	TL/Ad.
14000 004134	120x230x300	390	1.049,25

14000 004137

Bel Takım Çantası
Handyman Tool Belt**Bel Takım Çantası**

- Su geçirmez, sağlam, dayanıklı ve uzun ömürlü, 600x600 imperteks kumaş
- 3 farklı boyda cebi ve 8 el aleti askısı ile maksimum düzeni sağlayan kullanışlı model
- Reflektörlü ön cep
- Ayarlanabilir ve kullanışlı sağlam kemer

Handyman Tool Belt

- Waterproof, solid, resistant and long-lasting 600X600 impertex fabric
- Maximum organization providing functional model with 3 different sized pockets and 8 tool hangers
- Reflective front pocket
- Adjustable and functional solid belt

Bu çanta boş olarak satılmaktadır
This tool belt is sold empty

KOD/CODE	Ölçü / SIZE (mm)	g	TL/Ad.
14000 004137	424x594x851	290	635,00



Ürün Kodu:
14000005148

Ürün Kodu:
14000004133

Ürün Kodu:
14000004135

Ürün Kodu:
14000004134

Ürün Kodu:
14000004136

Ürün Kodu:
14000004137

**ŞABLON
BILLET**



**FİNAL ÜRÜN
FINAL PRODUCT**



İZELTAS®



ANAHTARLAR

WRENCHES

İki Ağız Anahtarlar

Open Jaw Wrenches

Kombine Anahtarlar

Combination Wrenches

Yıldız Anahtarlar

Ring Wrenches

Çakma Anahtarlar

Slugging Wrenches

Kurbağacık Anahtarlar

Adjustable Wrenches



İZELTAS YOUTUBE

İKİ AĞIZ ANAHTAR / DOUBLE ENDED OPEN JAW WRENCH

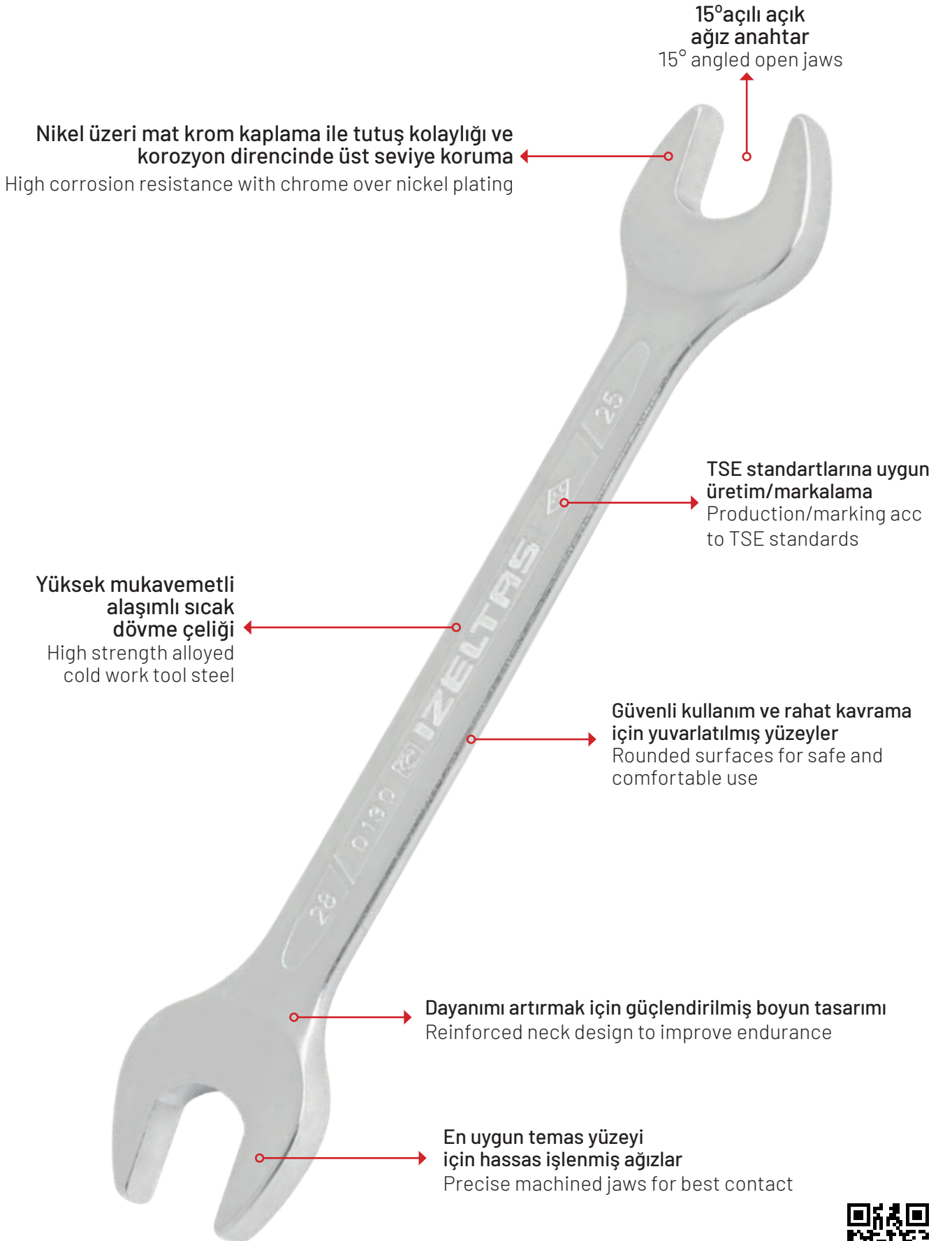

İki Ağız Anahtar Kısa Boy (mm)

Double Ended Open Jaw Wrench Short Pattern (mm)

 TS 81
DIN 895

İZELTAS YOUTUBE

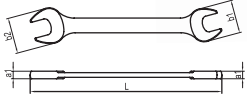
 Krom vanadyum, Krom kaplı
Chrom vanadium, Chrom plated

KOD CODE	mm	L mm	a1 mm	b1 mm	b2 mm	g	TL/ Ad.
0100 01 0405	4x5	97	3.5	11	12.5	15	61,25
0100 01 0607	6x7	97	3.5	14	16	18	63,00
0100 01 0809	8x9	108	4	18	20	30	64,50
0100 01 0810	8x10	117	4.5	18	22	33	71,00
0100 01 1011	10x11	120	4.6	22	24	41	70,25
0100 01 1012	10x12	120	4.6	22	26	35	70,25
0100 01 1013	10x13	120	4.6	22	28	38	75,25
0100 01 1213	12x13	133	5.2	26	28	57	77,25
0100 01 1214	12x14	147	5.2	26	30	59	77,25
0100 01 1314	13x14	147	5.2	28	30	66	77,25
0100 01 1415	14x15	147	5.8	30	32	78	89,00
0100 01 1317	13x17	162	6.2	28	36	80	101,25
0100 01 1417	14x17	162	6.2	30	36	90	104,00
0100 01 1617	16x17	162	6.2	34	36	109	104,00
0100 01 1719	17x19	178	7	36	40	143	111,75
0100 01 1819	18x19	178	7	38	40	144	111,75
0100 01 1922	19x22	195	7.4	40	46	175	125,50
0100 01 2022	20x22	195	7.4	42	46	196	130,00
0100 01 2123	21x23	213	7.7	44	48	230	136,25
0100 01 2224	22x24	213	8	46	50	239	142,25
0100 01 2426	24x26	232	8.2	50	54	297	146,50
0100 01 2427	24x27	232	8.2	50	56	296	146,50
0100 01 2528	25x28	248	8.6	52	57.5	366	181,50
0100 01 2732	27x32	265	9	56	66	415	216,50
0100 01 3032	30x32	265	9	62	66	465	216,50

**ÖZEL SERİLER (adet ve termin süresi isteyiniz)
SPECIAL SERIES (ask for quantity and delivery terms)**

0100 01 0608	6x8	97	3.5	14	18	20	10	-
0100 01 0708	7x8	108	3.5	16	18	20	10	-
0100 01 0709	7x9	108	4	16	20	25	10	-
0100 01 0910	9x10	117	4.6	20	22	30	10	-
0100 01 0911	9x11	120	4.6	20	24	30	10	-
0100 01 1014	10x14	120	5.2	22	30	50	10	-
0100 01 1113	11x13	133	5.2	26	28	50	10	-
0100 01 1114	11x14	133	5.2	26	28	50	10	-
0100 01 1315	13x15	147	5.2	28	30	65	10	-
0100 01 1722	17x22	195	7.4	36	46	160	10	-
0100 01 1820	18x20	178	7	38	40	125	10	-
0100 01 1822	18x22	195	7.4	40	46	160	10	-
0100 01 1924	19x24	213	7.7	40	50	200	10	-
0100 01 2226	22x26	232	8	46	54	250	10	-
0100 01 2227	22x27	232	8.2	46	56	260	10	-
0100 01 2430	24x30	265	9	50	62	370	10	-
0100 01 2730	27x30	265	9	56	62	380	10	-

0100
**İki Ağız Anahtar Takımı Kısa Boy (mm)
Double Ended Open Jaw Wrench
Short Pattern Set (mm)**

KOD CODE	İÇERİK CONTENTS	g	TL/ Ad.
0100 00 2108	6x7 - 8x9 - 10x11 12x13 - 14x15 - 16x17 18x19 - 20x22	736	8 709,75
0100 00 2112	6x7 - 8x9 - 10x11 12x13 - 14x15 - 16x17 18x19 - 20x22 - 21x23 24x26 - 25x28 - 30x32	2110	12 1.390,50

İki Ağız Anahtar Uzun Boy (mm)

Double Ended Open Jaw Wrench Long Pattern (mm)

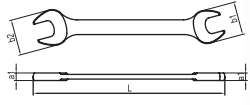

 TS ISO 10102
 DIN 3110

 Krom vanadyum, Krom kaplı
 Chrom vanadium, Chrom plated

KOD CODE	mm	L mm	a1 mm	b1 mm	b2 mm	g	TL/Ad.	
0130 01 0607	6x7	125	3.5	14	16	24	10	79,75
0130 01 0608	6x8	125	3.5	14	18	20	10	82,75
0130 01 0809	8x9	140	4	18	20	35	10	82,75
0130 01 0810	8x10	140	4	18	22	36	10	82,75
0130 01 1011	10x11	155	4.5	22	24	47	10	91,25
0130 01 1012	10x12	162	4.7	22	26	57	10	91,25
0130 01 1013	10x13	162	4.7	22	28	61	10	91,25
0130 01 1014	10x14	162	4.7	22	28	65	10	91,25
0130 01 1113	11x13	172	5	26	28	70	10	91,25
0130 01 1114	11x14	172	5	26	30	65	10	91,25
0130 01 1213	12x13	172	5	26	28	67	10	96,00
0130 01 1214	12x14	172	5	26	30	65	10	96,00
0130 01 1314	13x14	188	5.5	28	30	85	10	96,00
0130 01 1315	13x15	188	5.5	30	32	93	10	96,00
0130 01 1415	14x15	188	5.5	30	32	91	10	111,75
0130 01 1317	13x17	205	6.2	28	36	111	10	122,00
0130 01 1417	14x17	205	6.2	30	36	106	10	122,00
0130 01 1617	16x17	205	6.2	34	36	120	10	123,25
0130 01 1618	16x18	220	7	36	40	165	10	131,50
0130 01 1719	17x19	220	7	36	40	160	10	131,50
0130 01 1819	18x19	220	7	38	40	161	10	131,50
0130 01 1921	19x21	235	7.5	40	46	195	5	153,00
0130 01 1922	19x22	235	7.5	40	46	195	5	153,00
0130 01 2022	20x22	235	7.5	42	46	195	5	153,00
0130 01 1924	19x24	248	8.3	40	50	235	5	153,75
0130 01 2123	21x23	248	8.3	44	48	235	5	156,50
0130 01 2224	22x24	248	8.3	46	50	235	5	166,00
0130 01 2426	24x26	265	8.8	50	54	300	5	189,50
0130 01 2427	24x27	265	8.8	50	56	300	5	189,50
0130 01 2430	24x30	282	9.3	50	61.5	380	5	212,00
0130 01 2528	25x28	282	9.3	52	57.5	390	5	212,00
0130 01 2729	27x29	300	9.8	56	59	400	5	264,50
0130 01 2730	27x30	300	9.8	56	59	440	5	264,50
0130 01 2732	27x32	300	9.8	56	65.5	460	5	264,50
0130 01 3032	30x32	300	9.8	61.5	65.5	480	5	264,50
0130 01 3036	30x36	325	10.4	61.5	76	645	5	501,50
0130 01 3236	32x36	325	10.4	65.5	76	680	5	501,50
0130 01 3436	34x36	330	10.4	71	76	690	5	501,50
0130 01 3641	36x41	360	12	76	87	955	5	778,75
0130 01 4146	41x46	400	12.5	87	98	1300	5	1.200,75
0130 01 4650	46x50	450	13	98	107	1635	5	1.331,50

ÖZEL SERİLER (adet ve termin süresi isteyiniz)
SPECIAL SERIES (ask for quantity and delivery terms)

0130 01 0555	5x5.5	125	3.5	14	16	15	10	-
0130 01 0708	7x8	135	3.5	16	18	20	10	-
0130 01 0709	7x9	140	4	16	20	30	10	-
0130 01 0910	9x10	140	4	18	22	45	10	-
0130 01 0911	9x11	155	4.5	22	24	45	10	-
0130 01 1722	17x22	235	7.5	36	46	190	5	-
0130 01 1724	17x24	248	8.3	36	50	240	5	-
0130 01 2227	22x27	265	8.8	46	56	300	5	-

0130
İki Ağız Anahtar Takımı Uzun Boy (mm)

 Double Ended Open Jaw Wrench
 Long Pattern Set (mm)



KOD CODE	İÇERİK CONTENTS	g	TL/Ad.	
0130 00 2108	6x7 - 8x9 - 10x11 - 12x13 14x15 - 16x17 - 18x19 20x22	815	8	869,25
0130 00 2112	6x7 - 8x9 - 10x11 12x13 - 14x15 - 16x17 18x19 20x22 - 21x23 24x26 - 25x28 - 27x32	2315	12	1.691,75

0161

İki Ağız Anahtar Uzun Boy (SAE)

Double Ended Open Jaw Wrench Long Pattern (SAE)

TSEK



Krom vanadyum, Krom kaplı
Chrom vanadium, Chrom plated

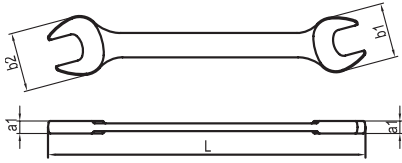

0161

İki Ağız Anahtar Takımı Uzun Boy (SAE)

Double Ended Open Jaw Wrench
Long Pattern Set (SAE)

TSEK

KOD CODE	inch	L mm	a1 mm	b1 mm	b2 mm	g	TL/ Ad.	
0161 01 0608	1/4"x5/16"	125	3.5	14	18	18	10	98,75
0161 01 0809	5/16"x3/8"	140	4	18	20	30	10	98,75
0161 01 0810	5/16"x11/32"	140	4	18	20	30	10	98,75
0161 01 0811	5/16"x7/16"	140	4	18	22	30	10	98,75
0161 01 0911	3/8"x7/16"	155	4.5	22	24	35	10	109,50
0161 01 1112	7/16"x1/2"	172	5	26	28	40	10	109,50
0161 01 1214	1/2"x9/16"	172	5	26	30	65	10	115,25
0161 01 1416	9/16"x5/8"	188	5.5	30	32	85	10	134,00
0161 01 1417	9/16"x11/16"	205	6.2	30	36	110	10	145,75
0161 01 1517	19/32"x11/16"	205	6.2	34	36	115	10	147,50
0161 01 1619	5/8"x3/4"	220	7	36	40	150	10	158,00
0161 01 1920	3/4"x25/32"	220	7	38	40	160	10	158,00
0161 01 2021	25/32"x13/16"	235	7.5	40	46	195	10	183,25
0161 01 1922	3/4"x7/8"	235	7.5	40	46	195	10	183,25
0161 01 2122	13/16"x7/8"	248	8.3	44	48	235	10	186,75
0161 01 2325	15/16"x1"	265	8.8	50	54	300	10	220,00
0161 01 2328	15/16"x1 1/8"	265	8.8	50	56	300	10	222,50
0161 01 2628	1 1/16"x1 1/8"	300	9.8	56	59.5	460	10	319,50
0161 01 2631	1 1/16"x1 1/4"	300	9.8	56	65.5	460	10	337,25
0161 01 2833	1 1/8"x1 5/16"	300	9.8	56	65.5	460	10	337,25



KOD CODE	İÇERİK CONTENTS	g	TL/ Ad.	
0161 00 2108	1/4"x5/16" - 5/16"x3/8" 7/16"x1/2" - 9/16"x5/8"-19/32"x11/16" 3/4"x25/32" - 13/16"x7/8"-15/16"x1"	1090	8	1.153,25
0161 00 2112	1/4"x5/16" - 5/16"x3/8" - 3/8"x7/16" 7/16"x1/2" - 1/2"x9/16" - 9/16"x5/8" 19/32"x11/16" - 3/4"x25/32" - 13/16"x7/8" 15/16"x1" - 1 1/16"x1 1/4" 1 1/8"x1 5/16"	2165	12	2.052,50

Bir Ağız Taçlı Anahtar (mm)
 Single Ended Open Jaw Wrench (mm)

TS 81

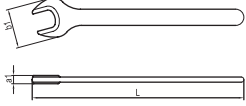
Krom vanadyum
 Chrom vanadium

KOD CODE	mm	L mm	a1 mm	b1 mm	g	TL/Ad.
0250 01 0030	30	260	10.5	60	250	1 365,75
0250 01 0036	36	300	10.5	74.5	370	1 461,50
0250 01 0041	41	345	12.2	85.5	550	1 602,00
0250 01 0046	46	390	14	96.5	750	1 648,25
0250 01 0050	50	423	15.2	105	1000	1 809,50
0250 01 0055	55	455	16.5	113.5	1300	1 1.084,00
0250 01 0060	60	490	17.6	121	1600	1 1.388,00
0250 01 0065	65	524	19	130	1980	1 1.691,75

ÖZEL SERİLER (adet ve termin süresi isteyiniz)
SPECIAL SERIES (ask for quantity and delivery terms)

0250 01 0021	21	185	8	42.4	95	1 -
0250 01 0022	22	195	8	44.4	110	1 -
0250 01 0023	23	195	8	46.3	115	1 -
0250 01 0024	24	215	9	48.3	150	1 -
0250 01 0025	25	215	9	50.3	155	1 -
0250 01 0027	27	240	9.5	54.3	200	1 -
0250 01 0032	32	274	11	63	300	1 -
0250 01 0034	34	274	11	68	320	1 -
0250 01 0038	38	300	10.5	76.8	400	1 -
0250 01 0070	70	564	20.8	140	2480	1 -
0250 01 0075	75	608	21.8	151	3100	1 -

Süper İzole Çatal Bir Ağız Anahtar (mm)
 Single Ended Open Jaw Wrench Super Insulated (mm)

 △ 1000 V
 IEC 60900

Krom vanadyum, Krom kaplı, Kalın PVC izoleli
 Chrom vanadium, Chrom plated, Triple PVC insulated

KOD CODE	mm	L mm	g	TL/Ad.
0255 01 0010	10	110	40	10 213,75
0255 01 0011	11	120	45	10 226,00
0255 01 0012	12	130	50	10 236,50
0255 01 0013	13	140	60	10 254,25
0255 01 0014	14	155	75	10 263,50
0255 01 0017	17	170	100	10 323,25
0255 01 0019	19	185	150	10 379,50
0255 01 0022	22	200	200	10 510,25
0255 01 0024	24	220	280	10 624,50

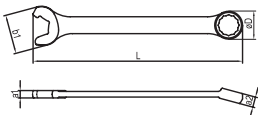
Montaj Anahtar (mm)
 Speed Wrench (mm)

Krom vanadyum, Krom kaplı
 Chrom vanadium, Chrom plated

KOD CODE	mm	L mm	a1 mm	a2 mm	b1 mm	øD mm	g	TL/Ad.
0325 02 0010	10	135	4.3	6.9	22	15.5	35	10 140,50
0325 02 0013	13	165	5.2	7.9	28	19.5	45	10 156,75
0325 02 0017	17	205	6.4	9.8	36	25.5	110	10 207,50
0325 02 0019	19	225	7	11	40	28.5	155	10 242,75
0325 02 0020	20	230	7.2	11.4	42	30	180	10 247,25
0325 02 0021	21	242	7.4	12	44	31.5	180	10 287,50
0325 02 0022	22	250	8.2	12.6	46	33	245	10 329,25

%100 Daha Hızlı

Yeni tasarlanan montaj anahtarı, 2 kat hızlıncir mekanizması mantığına dayanan çalışma prensibinden alır. Kullanım sırasında, montaj anahtarını civatadan ayırmadan döndürme kolaylığı kullanım hızını artırırken, civata köşelerine sağlam tutunan anahtar profili güvenli ve kaydırmaz kullanım sağlar.

Uzun Ömür

Bu yeni montaj anahtar profili, civata ve somunlar ile köşelerinden değil düz yüzeyleri üzerinden temas ederek düzenli tork iletimini sağlarken, gerilimin artmasını da engelleyerek anahtar ömrünün uzamasını sağlar.

- Anahtarı civatadan ayırmadan hızlı kullanım.
- Güvenli tork iletimi ve uzun ömür.

100% Faster

The 100% new design speed wrench takes the 2-fold speed from the operating principle based on the ratchet mechanism logic. While in use, the ease of rotation without detaching the mounting wrench from the bolt increases the speed of use and the profile that firmly secured to the corners ensures safe and non-slip use

Long Life

This new mounting wrench profile by contacting bolts and nuts, not on corners, but on their flat surfaces, allows regular torx transmission, prevents the increase in surface tension and provides longer life.

- Quick use without detaching the wrench from the bolt.
- Safe torx transmission and long



IZELTAS YOUTUBE

Kombine Anahtar Kısa Boy (mm)
 Combination Wrench Short Pattern (mm)

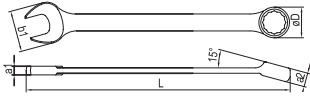
 TS 3794
 TS ISO 7738 Form A
 DIN 3113

 Krom vanadyum, Krom kaplı
 Chrom vanadium, Chrom plated

0320
Kombine Anahtar Takımı Kısa Boy (mm)
 Combination Wrench Short Pattern Set (mm)

KOD CODE	mm	L mm	a1 mm	a2 mm	b1 mm	øD mm	g	TL/ Ad.
0320 02 0005	5	90	3.4	5.1	14	10	15	10 79,75
0320 02 0055	5.5	90	3.4	5.1	14	10	15	10 79,75
0320 02 0006	6	100	3.4	5.1	14	10	15	10 82,75
0320 02 0007	7	110	3.6	5.5	16	11	20	10 87,75
0320 02 0008	8	120	3.8	5.9	18	13	25	10 95,75
0320 02 0009	9	130	4	6.3	20	14	30	10 97,75
0320 02 0010	10	140	4.3	6.9	22	15.5	40	10 110,25
0320 02 0011	11	150	4.5	7.3	24	17	45	10 113,00
0320 02 0012	12	160	4.9	7.7	26	18.5	55	10 120,75
0320 02 0013	13	170	5.2	7.9	28	19.5	60	10 123,25
0320 02 0014	14	180	5.5	8.7	30	21.5	75	10 133,50
0320 02 0015	15	190	5.8	9.1	32	22.5	90	10 142,25
0320 02 0016	16	200	6.1	9.6	34	24	105	10 153,00
0320 02 0017	17	210	6.4	9.8	36	25.5	120	10 163,50
0320 02 0018	18	220	6.8	10.4	38	27	145	10 181,50
0320 02 0019	19	232	7	11	40	28.5	170	10 191,25
0320 02 0020	20	240	7.2	11.4	42	30	195	10 195,00
0320 02 0021	21	250	7.4	12	44	31.5	190	10 226,00
0320 02 0022	22	260	8.2	12.6	46	33	275	10 257,50
0320 02 0023	23	270	8.3	13	48	35	255	5 257,50
0320 02 0024	24	280	8.5	13.6	50	36.5	320	5 316,00
0320 02 0025	25	290	8.8	14	52	39	320	5 316,00
0320 02 0026	26	300	9	14.8	54	41	400	5 372,00
0320 02 0027	27	310	9.3	15	56	41.5	400	5 372,00
0320 02 0028	28	320	9.4	15.4	57.5	42.5	380	5 372,00
0320 02 0029	29	330	10	15.6	59	43.5	510	5 425,75
0320 02 0030	30	340	10.3	16	61.5	44	505	5 425,75
0320 02 0032	32	370	10.5	16.2	65.5	47	560	5 447,25
0320 02 0034	34	400	10.7	16.8	71	50	675	5 467,50

KOD CODE	İÇERİK CONTENTS	g	TL/ Ad.
0320 00 2108	6 - 7 - 8 - 9 - 10 - 13 - 17 - 19	475	8 952,25
0320 00 2112	8 - 9 - 10 - 11 - 12 - 13 - 14 15 - 16 - 17 - 19 - 22	1190	12 1.701,75
0320 00 2117	6 - 7 - 8 - 9 - 10 - 11 - 12 - 13 - 14 15 - 16 - 17 - 18 - 19 - 20 - 21 - 22	1760	17 2.474,75
0320 00 2121	6 - 7 - 8 - 9 - 10 - 11 - 12 - 13 - 14 15 - 16 - 17 - 18 - 19 - 20 - 21 - 22 24 - 27 - 30 - 32	3650	21 4.035,75

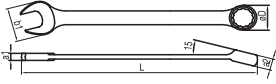
Kombine Anahtar Uzun Boy (mm)
Combination Wrench, Long Pattern (mm)

 TS 3794
 TS ISO 7738 Form A
 DIN 3113

 Krom vanadyum, Krom kaplı
 Chrom vanadium, Chrom plated

KOD CODE	mm	L mm	a1 mm	a2 mm	b1 mm	σD mm	g	TL/Ad.	
0330 02 0005	5	95	3.2	5.2	12.5	9	20	10	92,25
0330 02 0055	5.5	95	3.2	5.2	12.5	9	20	10	92,25
0330 02 0006	6	105	3.8	5.6	14	10.5	20	10	92,25
0330 02 0007	7	117	4	6.1	16	12	20	10	92,25
0330 02 0008	8	130	4.2	6.6	18	13.5	30	10	107,50
0330 02 0009	9	141	4.5	7	20	15	40	10	109,25
0330 02 0010	10	154	4.7	7.6	22	16	50	10	120,75
0330 02 0011	11	166	5	8.2	24	17.5	60	10	127,75
0330 02 0012	12	178	5.2	8.7	26	19	70	10	127,75
0330 02 0013	13	190	5.6	9.2	28	20.5	80	10	143,00
0330 02 0014	14	203	5.8	9.7	30	22	100	10	148,50
0330 02 0015	15	215	6.4	10.1	32	23.5	115	10	159,00
0330 02 0016	16	227	6.4	10.8	34	25	135	10	160,25
0330 02 0017	17	239	6.6	11.4	36	26.5	160	10	181,50
0330 02 0018	18	250	7	12	38	28	186	10	196,00
0330 02 0019	19	263	7.3	12.7	40	29.5	205	10	213,25
0330 02 0020	20	275	7.7	13.2	42	31	235	10	226,25
0330 02 0021	21	288	8.1	13.3	44	31.5	260	10	241,00
0330 02 0022	22	300	8.5	13.7	46	34	300	10	287,25
0330 02 0023	23	315	8.8	14.2	48	35.5	300	5	350,00
0330 02 0024	24	330	9	14.2	50	37	390	5	350,00
0330 02 0025	25	340	9.3	14.7	52	38.5	380	5	350,00
0330 02 0026	26	350	9.7	14.7	54	40	475	5	412,25
0330 02 0027	27	360	10	15.2	56	41	475	5	412,25
0330 02 0028	28	370	10.4	15.7	57.5	43	475	5	412,25
0330 02 0029	29	390	10.8	16.2	59	44	610	5	412,25
0330 02 0030	30	410	11.2	16.6	61.5	45	610	5	473,50
0330 02 0032	32	420	11.5	17.1	65.5	48	755	5	496,25
0330 02 0034	34	430	11.8	17.4	71	50.5	735	5	506,00
0330 02 0036	36	440	12.2	17.7	76	53	1000	5	573,25
0330 02 0038	38	450	12.5	18.7	80	56	1000	5	586,75
0330 02 0041	41	480	13.5	19.7	87	61	1240	5	667,75
0330 02 0046	46	505	14.7	20.7	95	67.5	1635	1	906,75
0330 02 0050	50	540	15.9	22.7	104	73.5	2100	1	1.229,25

0330
Kombine Anahtar Takımı Uzun Boy (mm)
Combination Wrench Long Pattern Set (mm)

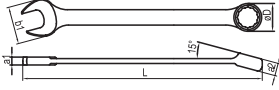
KOD CODE	İÇERİK CONTENTS	g	TL/Ad.	
0330 00 2108	6 - 7 - 8 - 9 - 10 - 13 17 - 19	665	8	1.059,75
0330 00 2112	8 - 9 - 10 - 11 - 12 13 - 14 - 15 - 16 17 - 19 - 22	1780	12	1.885,75
0330 00 2117	6 - 7 - 8 - 9 - 10 11 - 12 - 13 - 14 - 15 16 - 17 - 18 - 19 20 - 21 - 22	2170	17	2.733,50
0330 00 2121	6 - 7 - 8 - 9 - 10 - 11 12 - 13 - 14 - 15 - 16 17 - 18 - 19 - 20 - 21 22 - 24 - 27 - 30 - 32	4465	21	4.465,50

Kombine Anahtar Uzun Boy (SAE)
Combination Wrench Long Pattern (SAE)
TSEK

Krom vanadyum, Krom kaplı
Chrom vanadium, Chrom plated

KOD CODE	inch	L mm	a1 mm	a2 mm	b1 mm	ϕD mm	g	TL/ Ad.	
0331 02 0005	3/16"	95	3.2	5.2	12.5	9	15	10	110,25
0331 02 0006	1/4"	105	3.8	5.6	14	10.5	20	10	115,25
0331 02 0008	5/16"	130	4.2	6.6	18	13.5	30	10	133,50
0331 02 0010	3/8"	154	4.7	7.6	22	16	50	10	152,25
0331 02 0011	7/16"	166	5	8.2	24	17.5	60	10	160,00
0331 02 0013	1/2"	190	5.6	9.2	28	20.5	80	10	180,25
0331 02 0014	9/16"	203	5.8	9.7	30	22	100	10	189,25
0331 02 0015	19/32"	215	6.4	10.1	32	23.5	115	10	200,75
0331 02 0016	5/8"	227	6.4	10.8	34	25	135	10	215,50
0331 02 0017	11/16"	239	6.6	11.4	36	26.5	155	10	229,75
0331 02 0019	3/4"	263	7.3	12.7	40	29.5	205	10	267,75
0331 02 0020	25/32"	275	7.7	13.2	42	31	230	10	286,00
0331 02 0021	13/16"	288	8.1	13.3	44	31.5	260	5	316,00
0331 02 0022	7/8"	300	8.5	13.7	46	34	310	5	363,50
0331 02 0024	15/16"	330	9	14.2	50	37	380	5	445,00
0331 02 0025	1"	340	9.3	14.7	52	38.5	380	5	445,00
0331 02 0027	11/16"	360	10	15.2	56	41	470	5	520,75
0331 02 0028	11/8"	370	10.4	15.7	57.5	43	470	5	520,75
0331 02 0030	13/16"	410	11.2	16.6	61.5	45	635	5	596,00
0331 02 0032	11/4"	420	11.5	17.1	65.5	48	775	5	625,00
0331 02 0033	15/16"	430	11.8	17.4	71	50.5	775	5	625,00
0331 02 0038	11/2"	450	12.5	18.7	80	56	1015	5	755,25

ÖZEL SERİLER (adet ve termin süresi isteyiniz)
SPECIAL SERIES (ask for quantity and delivery terms)

0331 02 0035	13/8"	440	12.2	17.7	76	53	1015	5	-
0331 02 0036	17/16"	440	12.2	17.7	76	53	1015	5	-
0331 02 0041	15/8"	480	13.5	19.7	87	61	1325	5	-
0331 02 0046	113/16"	505	14.7	20.7	95	67.5	1750	5	-
0331 02 0050	2"	540	15.9	22.7	104	73.5	2200	5	-

0331
Kombine Anahtar Takımı Uzun Boy (SAE)
Combination Wrench Long Pattern Set (SAE)

KOD CODE	İÇERİK CONTENTS	g	TL/ Ad.	
0331 00 2108	5/16" - 3/8" - 7/16" - 1/2" - 9/16" - 5/8" 11/16" - 3/4"	925	8	1.528,25
0331 00 2112	5/16" - 3/8" - 7/16" - 1/2" - 9/16" - 5/8" 11/16" - 3/4" - 13/16" - 7/8" - 15/16" - 1"	2320	12	3.097,75
0331 00 2117	1/4" - 5/16" - 3/8" - 7/16" - 1/2" - 9/16" 19/32" - 5/8" - 11/16" - 3/4" - 25/32" 13/16" - 7/8" - 15/16" - 1" - 1 1/16" - 1 3/16"	3875	17	4.816,50
0331 00 2120	1/4" - 5/16" - 3/8" - 7/16" - 1/2" - 9/16" 19/32" - 5/8" - 11/16" - 3/4" - 25/32" 13/16" - 7/8" - 15/16" - 1" - 1 1/16" 1 1/8" - 1 3/16" - 1 1/4" - 1 5/16"	5880	20	6.587,25

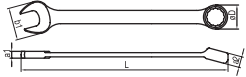
Circir Kombine Anahtar (mm)
 Combination Wrench With Ratchet (mm)

 Krom vanadyum, Krom kaplı
 Chrom vanadium, Chrom plated

KOD CODE	mm	L mm	a1 mm	a2 mm	b1 mm	øD mm	g	TL/Ad.
0340 02 0008	8	136	4.2	7.6	18.2	19.1	35	398,75
0340 02 0009	9	143	4.5	7.6	20.2	19.1	40	397,75
0340 02 0010	10	160	4.7	8	22.1	22	55	417,00
0340 02 0011	11	169	5	8	24.1	22	70	419,25
0340 02 0012	12	174	5.2	9	26.1	26	80	454,75
0340 02 0013	13	180	5.6	9	28.1	26	90	486,75
0340 02 0014	14	193	6	10	30.1	30	120	501,50
0340 02 0015	15	200	6.4	10	32.1	30	135	531,50
0340 02 0016	16	216	6.4	10.6	34.1	33	155	609,00
0340 02 0017	17	233	6.6	10.6	36.1	33	190	644,75
0340 02 0018	18	239	7	11.8	38	36.1	200	699,00
0340 02 0019	19	250	7.3	11.8	40	36.1	240	742,00
0340 02 0021	21	285	8.1	12.6	44	42.5	350	1.032,50
0340 02 0022	22	285	8.5	12.6	46	42.5	340	1.132,25
0340 02 0024	24	325	9	13.2	50	46.5	470	1.279,00

0340
Circir Kombine Anahtar Takımı (mm)
 Combination Wrench With Ratchet, Set (mm)



KOD CODE	İÇERİK CONTENTS	g	TL/Ad.
0340 00 2110	8 - 9 - 10 - 11 12 - 13 - 14 - 15 - 17 - 19	1315	10 4.994,00
0340 00 2115	8 - 9 - 10 - 11 - 12 - 13 14 - 15 - 16 - 17 - 18 - 19 - 21 - 22 - 24	2445	15 9.745,75

13000 005343
Circir Kombine Anahtar Takımı (4 parça, mm)
 Combination Wrench With Ratchet Set (4 pcs, mm)

KOD CODE	İÇERİK CONTENTS	g	TL/Ad.
13000 005343	10 - 13 - 17 - 19	595	4 2.290,50

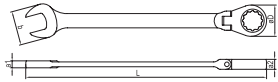

Mafsallı Cırcır Kombine Anahtar (mm) Flexible Head Combination Wrench With Ratchet (mm)



Krom vanadyum, Krom kaplı
Chrom vanadium, Chrom plated

KOD CODE	mm	L mm	a1 mm	a2 mm	b mm	σD mm	g		TL/Ad.
0345 02 0008	8	136	5.5	7	17	17.5	40	10	659,25
0345 02 0009	9	140	6.1	7.7	21.5	21	50	10	672,50
0345 02 0010	10	140	6.1	7.7	21.5	21	60	10	699,75
0345 02 0011	11	142	6.4	8.3	23.5	22.5	80	10	721,25
0345 02 0012	12	143	6.7	8.7	26	24	90	10	762,50
0345 02 0013	13	156	7	9.3	27	26	105	10	795,25
0345 02 0014	14	164	7.3	9.4	30.5	27.5	125	10	836,25
0345 02 0015	15	174	7.7	10	32	29	145	10	877,25
0345 02 0016	16	176	8	10.6	34	30.5	185	10	955,00
0345 02 0017	17	195	8.3	10.9	37	32.5	210	10	967,25
0345 02 0018	18	213	8.6	11.2	38.5	33.5	235	10	1.041,25
0345 02 0019	19	214	9	11.5	40	35	260	10	1.088,25

0345 00 2112

Mafsallı Cırcır Kombine Anahtar Takımı (mm) Flexible Head Combination Wrench With Ratchet, Set (mm)



KOD CODE	İÇERİK CONTENTS	g		TL/Ad.
0345 00 2112	8 - 9 - 10 - 11 - 12 - 13 14 - 15 - 16 - 17 - 18 - 19	1365	12	10.075,75

0335 02 0010

Çoklu Yıldız Cırcır Anahtar (mm) Multi-Ring Wrench (mm)



Krom vanadyum, Krom kaplı
Chrom vanadium, Chrom plated

KOD CODE	ÖLÇÜ SIZE	L mm	g		TL/Ad.
0335 02 0010	10x13x17x19	230	215	5	1.476,25

Boyunlu Kombine Anahtar (mm)
Offset Combination Wrench (mm)

TS 3794
TS ISO 7738 Form B
DIN 3113

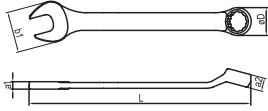

Krom vanadyum, Krom kaplı
Chrom vanadium, Chrom plated

0370
Boyunlu Kombine Anahtar Takımı (mm)
Offset Combination Wrench, Set (mm)

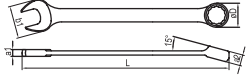

KOD CODE	mm	L mm	a1 mm	a2 mm	b1 mm	øD mm	g	TL/ Ad.
0370 02 0006	6	110	3.8	5.6	16	10.5	20	10 95,25
0370 02 0007	7	120	4	6.2	18	12	25	10 101,25
0370 02 0008	8	130	4.2	6.7	20	13	30	10 109,50
0370 02 0009	9	140	4.4	7.3	22	14.5	35	10 112,00
0370 02 0010	10	150	4.6	7.8	24	16	40	10 127,00
0370 02 0011	11	160	4.8	8.4	26	17	50	10 130,50
0370 02 0012	12	167	5	9	28	18.5	65	10 139,75
0370 02 0013	13	175	5.4	9.6	30	20	75	10 143,25
0370 02 0014	14	185	5.8	10.2	32	21.5	90	10 153,75
0370 02 0015	15	195	6.2	10.8	34	23	105	10 163,75
0370 02 0016	16	210	6.6	11.4	36	24.5	120	10 175,50
0370 02 0017	17	225	7	12	38	26	160	10 187,75
0370 02 0018	18	237	7.4	12.4	40	27.5	170	10 209,00
0370 02 0019	19	250	7.8	13	42	29	200	10 220,00
0370 02 0020	20	267	8.2	13.2	44	30.5	230	10 230,75
0370 02 0021	21	283	8.6	13.8	46	32	265	10 259,75
0370 02 0022	22	295	9.1	14.6	48	34.5	300	10 297,50
0370 02 0023	23	295	9.1	14.6	48	34.5	300	5 363,00
0370 02 0024	24	329	9.4	15.4	52	37	380	5 363,00
0370 02 0025	25	329	9.4	15.4	52	37	380	5 363,00
0370 02 0026	26	360	10.2	16.8	58	41	485	5 427,25
0370 02 0027	27	360	10.2	16.8	58	41	475	5 427,25
0370 02 0028	28	360	10.2	16.8	58	41	470	5 427,25
0370 02 0029	29	394	11	18.2	64	44.5	610	5 475,75
0370 02 0030	30	394	11	18.2	64	44.5	620	5 490,75
0370 02 0032	32	435	11.8	19.7	66	47.5	765	5 514,75
0370 02 0036	36	468	12.6	21.2	76	53	1020	5 595,00

KOD CODE	İÇERİK CONTENTS	g	TL/ Ad.
0370 00 2108	6 - 7 - 8 - 9 - 10 - 13 - 17 - 19	665	8 1.096,00
0370 00 2112	8 - 9 - 10 - 11 - 12 - 13 - 14 15 - 16 - 17 - 19 - 22	1375	12 1.960,25
0370 00 2117	6 - 7 - 8 - 9 - 10 - 11 - 12 - 13 - 14 15 - 16 - 17 - 18 - 19 - 20 - 21 - 22	2100	17 2.856,25
0370 00 2121	6 - 7 - 8 - 9 - 10 - 11 - 12 - 13 - 14 - 15 16 - 17 - 18 - 19 - 20 - 21 - 22 - 24 - 27 30 - 32	4425	21 4.652,00

Torx® - mm Kombine Anahtar
Torx® - mm Combination Wrench

Krom vanadyum, Krom kaplı
Chrom vanadium, Chrom plated

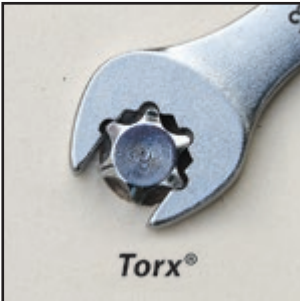
KOD CODE	mm	*	L mm	a1 mm	a2 mm	b1 mm	øD mm	g	□	TL/ Ad.
0380 02 0008	8	E10	170	4.5	7.5	20.5	13	45	10	190,50
0380 02 0009	9	E12	180	4.5	8	22.5	14.5	45	10	193,75
0380 02 0010	10	E14	190	5	8.5	24.5	16	60	10	214,50
0380 02 0011	11	E14	200	5.5	9	26.5	17	75	10	226,25
0380 02 0012	12	E16	210	6	9.5	28.5	19	90	10	232,25
0380 02 0013	13	E18	225	6.5	10	30.5	20	110	10	254,75
0380 02 0014	14	E18	235	7	11	32.5	22	120	10	282,00
0380 02 0015	15	E20	250	7.5	12	34.5	23	150	10	298,25
0380 02 0017	17	E22	280	8.5	14	38.5	26.5	210	10	323,75
0380 02 0018	18	E24	295	9	15	40.5	28	240	10	351,75
0380 02 0019	19	E24	310	9.5	16	42.5	29.5	280	10	380,25
0380 02 0022	22	E26	350	11	18	48.5	34.5	410	10	511,75

0380
Torx® - mm Kombine Anahtar Takımı
Torx® - mm Combination Wrench Set

Torx® - mm Kombine Anahtar: Bir çatal ağız ve bir yıldız ağızdan oluşan anahtarlarımız 8-22 mm arasında boyları bulunmaktadır. Çatal ağız kısmı mevcut çatal anahtarlardan farklı olarak 6 köşe civatanın yanısıra farklı geometri lere sahip civataları açabilmekte ve sıkabilmektedir.

TORX-mm combination wrench: Our wrenches consisting of an open end and a ring end are available in sizes from 8 to 22 mm. Unlike the existing open end wrenches, its open end can unbolt and tighten bolts with different geometries as well as the

KOD CODE	İÇERİK CONTENTS	g	□	TL/Ad.
	8 - 9 - 10 - 11 - 12 - 13 - 17 - 19			
0380 00 2108	E10 - E12 - E14 - E14 E16 - E18 - E22 - E24	790	8	2.016,00
	8 - 9 - 10 - 11 - 12 - 13 14 - 15 - 17 - 18 - 19 - 22			
0380 00 2112	E10 - E12 - E14 - E14 - E16 - E18 E18 - E20 - E22 - E24 - E24 - E26	1590	12	3.459,75

Yıldız İki Ağız Anahtar (mm)
Double Ended Ring Wrench (mm)

TS 3794
TS ISO 10104 Form B
DIN 838

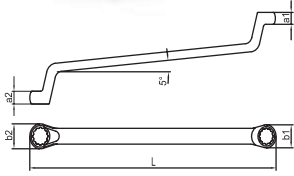

Krom vanadyum, Krom kaplı
Chrom vanadium, Chrom plated

KOD CODE	mm	L mm	a1 mm	a2 mm	b1 mm	b2 mm	g	TL/Ad.
0430 03 0607	6x7	176	5.6	6	10	11.5	55	10 143,00
0430 03 0809	8x9	190	6.4	6.8	13	14.5	75	10 145,00
0430 03 0810	8x10	190	6.4	7.3	13	15.5	70	10 145,00
0430 03 1011	10x11	206	7.3	7.6	15.5	17	105	10 160,25
0430 03 1012	10x12	206	7.3	8.5	15.5	18.5	105	10 160,25
0430 03 1013	10x13	220	7.3	9	15.5	20	120	10 181,50
0430 03 1113	11x13	220	8.5	9	18.5	20	130	10 181,50
0430 03 1213	12x13	220	8.5	9	18.5	20	135	10 181,50
0430 03 1214	12x14	220	8.5	9.5	18.5	23	145	10 181,50
0430 03 1415	14x15	236	9.5	10	21.5	23	180	10 191,25
0430 03 1317	13x17	250	9	11.5	20	26.5	215	10 216,50
0430 03 1417	14x17	250	9.5	11.5	21.5	26.5	210	10 216,50
0430 03 1617	16x17	250	10.8	11.5	25	26.5	220	10 216,50
0430 03 1618	16x18	260	10.8	12	25	27.5	210	10 257,25
0430 03 1719	17x19	271	11.5	12.5	26.5	29	270	10 257,25
0430 03 1819	18x19	271	12	12.5	27.5	29	270	10 257,25
0430 03 1922	19x22	291	12.5	13.5	29	33	330	5 282,00
0430 03 1924	19x24	311	12.5	14.2	29	36.5	345	5 282,00
0430 03 2022	20x22	291	12.9	13.5	30.5	33	330	5 282,00
0430 03 2123	21x23	311	13.1	14	32	35	410	5 323,25
0430 03 2224	22x24	321	13.5	14.2	33	36.5	410	5 323,25
0430 03 2426	24x26	331	14.2	14.6	36.5	39.5	495	5 376,75
0430 03 2427	24x27	331	14.2	15	36.5	40.5	495	5 376,75
0430 03 2430	24x30	352	14.2	16.7	36.5	45	530	5 412,25
0430 03 2528	25x28	352	14.5	15.5	38	42.5	550	5 412,25
0430 03 2729	27x29	371	15	16.7	40.5	45	660	5 453,50
0430 03 2730	27x30	371	15	16.7	40.5	45	660	5 453,50
0430 03 2732	27x32	371	15	16.7	40.5	47.5	660	5 453,50
0430 03 3032	30x32	371	16.4	16.7	45	47.5	660	5 453,50
0430 03 3036	30x36	402	16.4	17.5	45	53	880	5 699,00
0430 03 3236	32x36	402	16.7	17.5	47.5	53	890	5 699,00
0430 03 3436	34x36	420	17.1	17.5	50	53	1000	5 854,75
0430 03 3641	36x41	438	17.5	19.5	53	61	1150	5 949,50
0430 03 4146	41x46	485	19.5	20.5	61	67.5	1430	5 1.300,75
0430 03 4650	46x50	535	20.5	22.4	67.5	73.5	1960	5 2.069,50

ÖZEL SERİLER (adet ve termin süresi isteyiniz)
SPECIAL SERIES (ask for quantity and delivery terms)

0430 03 1014	10x14	220	7.3	9	15.5	21.5	120	10 -
0430 03 1315	13x15	236	9	10	20	23	170	10 -
0430 03 2227	22x27	331	14.2	15	36.5	40.5	500	5 -
0430 03 3034	30x34	379	16.4	16.9	45	50	690	5 -

0430
Yıldız İki Ağız Anahtar Takımı (mm)
Double Ended Ring Wrench Set (mm)

KOD CODE	İÇERİK CONTENTS	g	TL/Ad.
0430 00 2108	6x7 - 8x9 - 10x11 - 12x13 - 14x15 16x17 - 18x19 - 20x22	1450	8 1.576,75
0430 00 2112	6x7 - 8x9 - 10x11 - 12x13 - 14x15 16x17 - 18x19 - 20x22 - 21x23 24x26 - 25x28 - 27x32	3610	12 3.142,50

Yıldız İki Ağz Anahtar (SAE)
Double Ended Ring Wrench (SAE)
TSEK

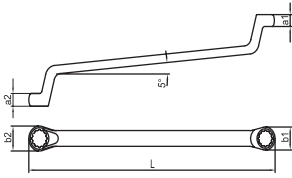
Krom vanadyum, Krom kaplı
Chrom vanadium, Chrom plated
0431
Yıldız İki Ağz Anahtar Takımı (SAE)
Double Ended Ring Wrench, Set (SAE)
TSEK

KOD CODE	inch	L mm	a1 mm	a2 mm	b1 mm	b2 mm	g	TL/ Ad.
0431 03 0608	1/4"x5/16"	176	5.6	6	10	11.5	55	10 176,25
0431 03 0809	5/16"x3/8"	190	6.4	6.8	13	14.5	75	10 183,25
0431 03 0811	5/16"x7/16"	190	6.4	7.3	13	15.5	115	10 191,50
0431 03 0911	3/8"x7/16"	206	7.3	7.6	15.5	17	115	10 202,00
0431 03 1112	7/16"x1/2"	220	8.5	9	18.5	20	135	10 218,00
0431 03 1214	1/2"x9/16"	236	9	10	20	23	145	10 229,75
0431 03 1415	9/16"x19/32"	236	9.5	10	21.5	23	165	10 229,75
0431 03 1416	9/16"x5/8"	236	9.5	10	21.5	24	165	10 232,00
0431 03 1517	19/32"x11/16"	250	10.8	11.5	25	26.5	210	10 259,75
0431 03 1920	3/4"x25/32"	271	12	12.5	27.5	29	270	10 322,25
0431 03 2122	13/16"x7/8"	311	13.1	14	32	35	400	5 387,25
0431 03 2325	15/16"x1"	331	14.2	14.6	36.5	39.5	495	5 452,00
0431 03 2831	1 1/16"x1 1/4"	371	15	16.7	40.5	48	640	5 544,00
0431 03 2833	1 1/8"x1 5/16"	371	15	16.7	40.5	48	660	5 544,00
0431 03 3033	1 3/16"x1 5/16"	371	16.4	16.7	45	48	670	5 580,00

ÖZEL SERİLER (adet ve termin süresi isteyiniz)
SPECIAL SERIES (ask for quantity and delivery terms)

0431 03 1217	1/2"x11/16"	250	9	10	20	26.5	185	10 -
0431 03 1417	9/16"x11/16"	250	9.5	11.5	21.5	26.5	185	10 -
0431 03 1617	5/8"x11/16"	250	10.8	11.5	25	26.5	210	10 -
0431 03 1619	5/8"x3/4"	271	11.5	12.5	26.5	29	270	10 -
0431 03 2021	25/32"x13/16"	291	12.9	13.5	30.5	33	270	5 -
0431 03 1922	3/4"x7/8"	291	12.9	13.5	30.5	33	400	5 -
0431 03 2223	7/8"x15/16"	321	13.5	14.2	33	36.5	400	5 -
0431 03 2328	15/16"x1 1/8"	331	14.2	15	36.5	40.5	500	5 -
0431 03 2528	1"x1 1/8"	352	14.5	15.5	38	42.5	570	5 -
0431 03 3036	1 3/16"x1 3/8"	402	16.4	17.5	45	53	880	5 -
0431 03 3236	1 1/4"x1 7/16"	402	16.7	17.5	48	53	890	5 -
0431 03 3641	1 7/16"x1 5/8"	438	17.5	19.5	53	61	1100	5 -
0431 03 4146	1 11/16"x1 7/8"	485	19.5	20.5	61	67.5	1390	5 -
0431 03 4650	1 13/16"x2"	535	20.5	22.5	67.5	73.5	1955	5 -



KOD CODE	İÇERİK CONTENTS	g	TL/ Ad.
0431 00 2108	1/4"x5/16" - 5/16"x3/8" 7/16"x1/2" - 9/16"x5/8" 19/32"x11/16" 3/4"x25/32" - 13/16"x7/8" 15/16"x1"	1915	8 2.230,75
0431 00 2112	1/4"x5/16" - 5/16"x3/8" 3/8"x7/16" - 7/16"x1/2" 9/16"x5/8" - 19/32"x11/16" 3/4"x25/32" - 13/16"x7/8" 15/16"x1" - 1 1/16"x1 1/4" 1 1/8"x1 5/16" 1 3/16"x1 5/16"	3985	12 4.100,75

Düz Yıldız Anahtar (mm)
 Flat Ring Wrench (mm)

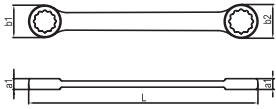
 TS 3794
 TS ISO 10103
 DIN 837 -B

 Krom vanadyum, Krom kaplı
 Chrom vanadium, Chrom plated

KOD CODE	mm	L mm	a1 mm	b1 mm	b2 mm	g	TL/ Ad.
0440 03 0607	6x7	99	4.4	9.5	11	10	131,50
0440 03 0809	8x9	113	5.2	12.5	14	25	137,50
0440 03 1011	10x11	125	6	15.5	16.5	30	152,25
0440 03 1213	12x13	140	6.8	18.5	20	45	164,25
0440 03 1415	14x15	156	7.2	21	22.5	60	191,25
0440 03 1617	16x17	170	8	24	25	80	226,25
0440 03 1819	18x19	188	8.8	26.5	27.5	105	236,75
0440 03 2022	20x22	208	9.6	29	32	135	275,00
0440 03 2123	21x23	230	10.6	30	33	170	325,75
0440 03 2426	24x26	256	10.8	35	37.5	225	330,00
0440 03 2528	25x28	280	11.8	36	40.5	270	384,75
0440 03 2732	27x32	310	12.8	38.5	45.5	355	475,50

0440
Düz Yıldız Anahtar Takımı (mm)
 Flat Ring Wrench, Set (mm)

ÖZEL SERİLER (adet ve termin süresi isteyiniz)
SPECIAL SERIES (ask for quantity and delivery terms)

0440 03 0810	8x10	120	5.6	12.5	15.5	30	10	-
0440 03 1013	10x13	140	6.8	18.5	20	45	10	-
0440 03 1315	13x15	156	7.2	20	22.5	55	10	-
0440 03 1317	13x17	165	7.8	20.2	25.2	85	10	-
0440 03 1618	16x18	188	8.8	26.5	27.5	90	10	-
0440 03 1719	17x19	188	8.8	26.5	27.5	105	10	-
0440 03 2224	22x24	230	10.8	32	35	170	10	-
0440 03 2427	24x27	256	10.8	35	38.5	225	10	-
0440 03 2729	27x29	290	12.8	38.5	42.5	285	10	-
0440 03 3032	30x32	310	12.8	43	45.5	360	10	-

KOD CODE	İÇERİK CONTENTS	g	TL/ Ad.
0440 00 2108	6x7 - 8x9 - 10x11 - 12x13 - 14x15 16x17 - 18x19 - 20x22	560	8 1.514,75
0440 00 2112	6x7 - 8x9 - 10x11 - 12x13 - 14x15 16x17 - 18x19 - 20x22 - 21x23 24x26 - 25x28 - 27x32	1540	12 3.030,75

0435

Süper İzoleli Bir Ağız Yıldız Anahtar (mm)
Single Ended Ring Wrench Super Insulated (mm)

⚡ 1000 V
IEC 60900



Krom vanadyum, Krom kaplı, Kalın PVC izoleli
Chrom vanadium, Chrom plated, Triple PVC insulated

KOD CODE	mm	L mm	g	TL/Ad.
0435 03 0010	10	170	100	285,00
0435 03 0011	11	175	110	285,00
0435 03 0012	12	180	130	323,25
0435 03 0013	13	185	150	323,25
0435 03 0014	14	190	180	339,75
0435 03 0017	17	205	220	384,50
0435 03 0019	19	220	270	458,75
0435 03 0022	22	245	310	502,50
0435 03 0024	24	270	420	671,50

0530

Yarım Ay Anahtar Yıldız İki Ağız (mm)
Double - Hex Starter and Block Wrench (mm)

TSEK

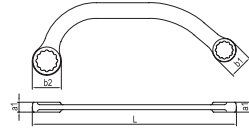

Krom vanadyum, Krom kaplı
Chrom vanadium, Chrom plated

KOD CODE	mm	L mm	a1 mm	b1 mm	b2 mm	g	TL/Ad.
0530 04 0810	8x10	120	6	12.5	15.5	30	169,25
0530 04 1011	10x11	150	7	17	20	55	198,50
0530 04 1012	10x12	150	7	17	20	55	198,50
0530 04 1113	11x13	150	7	17	20	55	198,50
0530 04 1315	13x15	185	9	21.5	26	110	236,50
0530 04 1317	13x17	185	9	21.5	26	105	236,50
0530 04 1417	14x17	185	9	21.5	26	110	236,50
0530 04 1517	15x17	185	9	21.5	26	100	236,50
0530 04 1922	19x22	230	11	29	33	195	307,25

0540

Rakor Anahtar (mm)
Flare Nut Wrench (mm)

DIN 3118

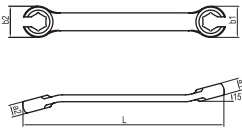

Krom vanadyum, Krom kaplı
Chrom vanadium, Chrom plated

KOD CODE	mm	L mm	a1 mm	a2 mm	b1 mm	b2 mm	g	TL/Ad.
0540 01 0810	8x10	130	7	8.5	18	20	60	262,25
0540 01 1011	10x11	150	8.5	9.3	20	22	75	272,25
0540 01 1012	10x12	150	8.5	9.3	20	22	75	272,25
0540 01 1113	11x13	170	9.3	10.8	22	25.5	105	291,25
0540 01 1214	12x14	170	9.3	10.8	22	25.5	105	291,25
0540 01 1719	17x19	210	11.8	13	30.5	33.5	185	520,00
0540 01 1922	19x22	230	12.8	14.9	33.5	39.5	235	622,50

0531

Yarım Ay Anahtar Yıldız İki Ağız (SAE)
Double - Hex Starter and Block Wrench (SAE)

TSEK

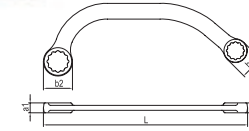

Krom vanadyum, Krom kaplı
Chrom vanadium, Chrom plated

KOD CODE	inch	L mm	a1 mm	b1 mm	b2 mm	g	TL/Ad.
0531 04 1112	7/16"x1/2"	150	7	17	20	50	244,75
0531 04 1214	1/2"x9/16"	185	9	21.5	26	110	284,50
0531 04 1416	9/16"x5/8"	185	9	21.5	26	115	293,00
0531 04 1922	3/4"x7/8"	230	11	29	33	195	369,25

ÖZEL SERİLER (adet ve termin süresi isteyiniz)
SPECIAL SERIES (ask for quantity and delivery terms)

0531 04 0809	5/16"x3/8"	120	6	12.5	15.5	30	10	-
0531 04 0911	3/8"x7/16"	150	7	17	20	50	10	-
0531 04 1417	9/16"x11/16"	185	9	21.5	26	110	10	-

Çatal Çakma Anahtar (mm)
Slugging Open Jaw Wrench (mm)

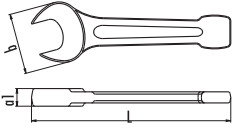
 TS 81
 DIN 133

Krom vanadyum
Chrom vanadium

KOD CODE	mm	L mm	a1 mm	b mm	g		TL/Ad.
0700 05 0024	24	160	14	50	280	1	340,75
0700 05 0027	27	180	15	55	385	1	422,75
0700 05 0030	30	190	16	64	525	1	519,00
0700 05 0032	32	190	16	64	530	1	582,50
0700 05 0036	36	210	18	75	755	1	654,00
0700 05 0038	38	210	18	75	760	1	787,50
0700 05 0041	41	230	18	85	920	1	855,00
0700 05 0042	42	230	18	85	930	1	988,00
0700 05 0046	46	255	20	95	1305	1	1.087,50
0700 05 0047	47	255	20	95	1320	1	1.270,00
0700 05 0050	50	275	20	105	1565	1	1.358,50
0700 05 0055	55	310	23	119	2305	1	1.820,75
0700 05 0060	60	310	23	119	2310	1	1.976,75
0700 05 0065	65	340	28	135	3300	1	2.843,25
0700 05 0070	70	375	31	154	4555	1	3.639,25
0700 05 0075	75	375	31	154	4460	1	3.856,00
0700 05 0080	80	405	34	169	6115	1	4.903,25
0700 05 0085	85	405	34	169	5740	1	6.500,00
0700 05 0090	90	445	38	189	8040	1	6.687,75
0700 05 0095	95	445	38	189	8160	1	7.132,25
0700 05 0100	100	485	44	214	12355	1	10.108,25
0700 05 0105	105	485	44	214	11785	1	10.423,50
0700 05 0110	110	510	50	234	15000	1	11.893,25
0700 05 0115	115	510	50	234	14830	1	13.662,00
0700 05 0120	120	543	54	254	18865	1	14.421,00

ÖZEL SERİLER (adet ve termin süresi isteyiniz)
SPECIAL SERIES (ask for quantity and delivery terms)

0700 05 0125	125	543	54	254	17250	1	-
0700 05 0130	130	560	56	275	20000	1	-
0700 05 0135	135	560	56	275	19700	1	-
0700 05 0140	140	630	58.5	310	19400	1	-
0700 05 0145	145	630	58.5	310	28000	1	-
0700 05 0150	150	630	58.5	310	27600	1	-

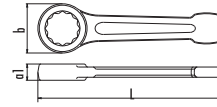
Yıldız Çakma Anahtar (mm)
Slugging Ring Wrench (mm)

 TS 3794
 DIN 7444

Krom vanadyum
Chrom vanadium

KOD CODE	mm	L mm	a1 mm	b mm	g		TL/Ad.
0750 05 0024	24	160	15	41.5	235	1	477,25
0750 05 0027	27	180	16	45.5	325	1	569,75
0750 05 0030	30	190	17	51	435	1	679,50
0750 05 0032	32	190	17	51	425	1	781,00
0750 05 0036	36	205	19	58	550	1	883,75
0750 05 0038	38	205	19	58	530	1	1.058,25
0750 05 0041	41	225	20	63	730	1	1.155,25
0750 05 0042	42	225	20	63	700	1	1.320,75
0750 05 0046	46	240	22	71	970	1	1.381,00
0750 05 0047	47	240	22	71	930	1	1.524,00
0750 05 0050	50	255	23	77	1160	1	1.630,50
0750 05 0055	55	272	25	88	1520	1	2.293,50
0750 05 0060	60	272	25	88	1460	1	2.488,50
0750 05 0065	65	300	28	98	2025	1	3.253,00
0750 05 0070	70	330	32	108	2890	1	3.724,25
0750 05 0075	75	330	32	108	2755	1	3.986,25
0750 05 0080	80	360	35	126	4000	1	5.661,50
0750 05 0085	85	360	35	126	3620	1	6.369,75
0750 05 0090	90	390	40	140	5465	1	7.835,25
0750 05 0095	95	390	40	140	5250	1	8.835,00
0750 05 0100	100	420	44	148	6755	1	10.213,50
0750 05 0105	105	420	44	148	6445	1	10.543,00
0750 05 0110	110	450	48	166	8500	1	11.270,50
0750 05 0115	115	450	48	166	8460	1	12.633,50
0750 05 0120	120	490	54	178	10000	1	17.363,25

ÖZEL SERİLER (adet ve termin süresi isteyiniz)
SPECIAL SERIES (ask for quantity and delivery terms)

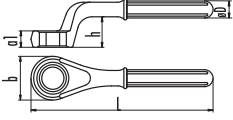
0750 05 0125	125	490	54	178	9900	1	-
0750 05 0130	130	518	59	196	16000	1	-
0750 05 0135	135	518	59	196	15900	1	-
0750 05 0140	140	518	59	196	15800	1	-
0750 05 0145	145	580	61.8	223	22000	1	-
0750 05 0150	150	580	61.8	223	21900	1	-
0750 05 0155	155	580	61.8	223	21800	1	-
0750 05 0160	160	580	61.8	223	21700	1	-
0750 05 0165	165	648	67	262	30000	1	-
0750 05 0170	170	648	67	262	29800	1	-
0750 05 0180	180	648	67	262	29700	1	-

0550
Boru Uzatmalı Yıldız Anahtar (mm)
Offset Ring Wrench (mm)

Krom vanadyum, Krom kaplı
Chrom vanadium, Chrom plated

KOD CODE	Ø mm	L mm	a1 mm	b mm	ØD mm	h mm	g	TL/Ad.
0550 05 0024	24	180	17	37	18.5	30	400	1 498,75
0550 05 0027	27	190	18	42	18.5	33	450	1 594,75
0550 05 0030	30	200	20	46	18.5	34	520	1 710,00
0550 05 0032	32	235	21.5	49	21.2	37	700	1 815,25
0550 05 0036	36	245	23	53.5	21.2	42	830	1 922,00
0550 05 0038	38	270	25	60.5	21.2	43	965	1 1.063,75
0550 05 0041	41	270	25	60.5	21.2	43	950	1 1.205,00
0550 05 0046	46	280	26	68	24.2	45	1240	1 1.441,25
0550 05 0050	50	290	28	74	24.2	47	1410	1 1.701,75
0550 05 0055	55	300	30	79	24.2	50	1550	1 2.393,25
0550 05 0060	60	345	32	89	29	50.5	2390	1 2.597,25
0550 05 0065	65	355	34	98	29	56.5	2730	1 2.812,50

ÖZEL SERİLER (adet ve termin süresi isteyiniz)
SPECIAL SERIES (ask for quantity and delivery terms)

0550 05 0022	22	180	17	37	18.5	30	400	1 --
0550 05 0034	34	235	21.5	49	21.2	37	750	1 -
0550 05 0070	70	365	37	104	29	55	2900	1 -
0550 05 0075	75	375	40	109	29	57.5	3100	1 -
0550 05 0080	80	385	43	124	29	59	3900	1 -
0550 05 0085	85	385	43	124	29	59	3750	1 -
0550 05 0090	90	410	46	140	29	63	5100	1 -
0550 05 0095	95	410	46	140	29	63	4950	1 -
0550 05 0100	100	420	46	150	29	65	4800	1 -

0551
Döndürme Kolu Borusu
Tubular Handle

Dikişsiz Çelik Boru
Seamless Steel Pipe

KOD CODE	Ø mm	L mm	Ø mm	g	TL/Ad.
0551 05 0001	22 - 30	460	25	700	1 466,50
0551 05 0002	32 - 41	610	27	1220	1 632,00
0551 05 0003	46 - 55	760	32.2	1880	1 947,50
0551 05 0004	60 - 100	860	38	2975	1 1.278,25

0600
Kurbağacık Anahtar
Adjustable Wrench

TS ISO 6787

 **Yedek parça sayfa 242**
Spare parts page 242

İZELTAS YOUTUBE
Krom vanadyum, Krom kaplı, PVC izoleli
Chrom vanadium, Chrom plated, PVC insulated



KOD CODE	L mm	L inch	a mm	g	TL/Ad.
0600 01 1006	160	6"	18	120	5 458,75
0600 01 1008	208	8"	23	230	5 573,75
0600 01 1010	260	10"	28	400	5 739,25
0600 01 1012	308	12"	34	670	5 1.021,50
0600 01 1015	388	15"	43	1555	1 1.600,25

0600 01 0010
1000V İzoleli Kurbağacık Anahtar
Insulated Electrician Type Adjustable Wrench 1000V
TS ISO 6787
⚡ 1000 V / IEC 60900

 **Yedek parça sayfa 242**
Spare parts page 242
Krom vanadyum, Krom kaplı, Kalın PVC izoleli
Chrom vanadium, Chrom plated, Triple PVC insulated

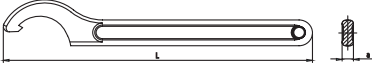
KOD CODE	L mm	L inch	a mm	g	TL/Ad.
0600 01 0010	260	10"	28	440	5 1.077,00

 Krom vanadyum, Krom kaplı
 Chrom vanadium, Chrom plated

KOD CODE	 mm	L mm	a1 mm	 g		TL/Ad.
0860 05 2528	25/28	136	4	50	10	244,75
0860 05 3032	30/32	136	4	50	10	244,75
0860 05 3436	34/36	171	5	95	10	264,50
0860 05 4042	40/42	171	5	95	10	264,50
0860 05 4550	45/50	210	6	160	10	306,25
0860 05 5255	52/55	210	6	160	10	306,25
0860 05 5862	58/62	242	7	270	5	369,50
0860 05 6875	68/75	242	7	270	5	369,50
0860 05 8090	80/90	281	8	400	5	482,50
0860 05 9510	95/100	281	8	400	5	482,50

0615 01 0200
Ayarlı Montaj Anahtarı
 Adjustable Speed Wrench

 İZELTAS USTA İŞİ
 SOHBETLER

Yedek parça sayfa 242
 Spare parts page 242

 Krom vanadyum, Krom kaplı
 Chrom vanadium, Chrom plated

KOD CODE	L mm	L inch	a mm	 g		TL/Ad.
★ 0615 01 0200	200	8"	6-22	220	5	753,25

 6 ile 22 mm arası **Altı Köşe, Torx, XZN, Ribe, Kare** gibi farklı geometriye sahip cıvataları açabilme imkanı sağlar. Anahtarı cıvata başından tam olarak çıkarmadan açma ve sıkma hareketi olanağı sağlar. Anahtar sapına özel olarak açılmış 10-13-15 mm altı köşe cıvataları açabilme imkanı sağlar

 Allows to open bolts with different geometry such as **Hexagon, Torx, XZN, Ribe, Square** in sizes from 6 to 22 mm. Enables unbolting and tightening turn without removing the wrench completely from the bolt head. Specially opened 10-13-15 mm holes on the handle, allows to open hexagon bolts.

★ Stoklarla sınırlıdır / It is limited by stocks

MCD ÇOK NOKTADAN TEMAS PROFİLİ / MCD MULTI CONTACT DRIVE PROFILE



İzeltas Yeni Jenerasyon Yıldız Anahtar Profili

MCD, Multi Contact Drive (çoklu temas), sıkma performansının geliştirilmesi amacıyla dizayn edilmiştir. Bilgisayar destekli titiz çalışmaların sonucunda geliştirilen MCD, klasik 12 köşe anahtardan çok daha kullanışlı, çok daha güçlüdür.

En önemli özelliği, yıldız kafadaki çoklu temas yüzeleridir. Bu sayede civata ve somunla maksimum temas sağlanır. Böylece basınç tüm köşelere eşit olarak dağılır, temas edilen yüzelerdeki olası hasarlar önlenir, aletin ömrü uzar.

- ☛ Yıldız kafadaki yeni profil, düzenli bir dalga şeklindedir. Güç, civatanın köşelerine değil, yan yüzelerine etki eder (çoklu temas). Basınç daha dengeli dağıldığından temas edilen yüzelerde ezilme meydana gelmez.
- ☛ Tolerans dışı civatalar için de uygundur.
- ☛ Civata başlarının köşelerini ezmez.
- ☛ Geniş temas alanı, anahtar ömrünü artırır.
- ☛ Bozuk ve deforme olmuş civataları kolayca açar.

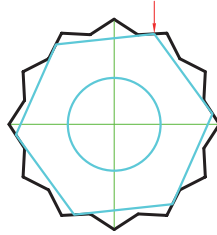

Çoklu Temas / Multi Point Contact

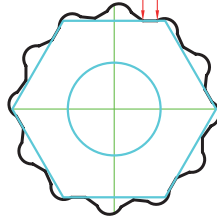

MCD Profil
MCD Profile

IZELTAS New Generation Ring Wrench Profile

MCD (Multi Contact Drive) is designed to improve the driving performance of the ring wrench. MCD, designed through computer aided drafting, transmits more torque and has longer life than conventional 12 edge ring profile.

Multi point contact is the source of effectiveness, where maximum surface area is in touch with fastener flats. Increased contact also maximizes tool's life through decreased pressure on the contact points.

- ☛ New profile of the ring wrench is formed of curves. Torque is transmitted through these curves rather than edges. As the stress is balanced between enlarged surfaces, the risk of deformation is minimized.
- ☛ It is possible to drive off-tolerance fasteners.
- ☛ Does not deform the fastener edges.
- ☛ Larger contact area increases tool's life.
- ☛ Works well with deformed fasteners.

MONTAJ ANAHTARI / SPEED WRENCH



%100 Daha Hızlı

Yeni tasarlanan montaj anahtarı, 2 kat hızını cırcır mekanizması mantığına dayanan çalışma prensibinden alır. Kullanım sırasında, montaj anahtarını civatadan ayırmadan döndürme kolaylığı kullanım hızını artırırken, civata köşelerine sağlam tutunan anahtar profili güvenli ve kaydırmaz kullanım sağlar.

Uzun Ömür

Bu yeni montaj anahtarı profili, civata ve somunlar ile köşelerinden değil düz yüzeyleri üzerinden temas ederek düzenli tork iletimini sağlarken, gerilimin artmasını da engelleyerek anahtar ömrünün uzamasını sağlar.

- ☛ Anahtarı civatadan ayırmadan hızlı kullanım.
- ☛ Güvenli tork iletimi ve uzun ömür.

100% Faster

New designed speed wrench takes its 100% faster rotational drive from the ratchet mechanism principle. Rotating the tool without the need for removing from the fastener provides faster usage, while enabling safer and slip-free usage with fully gripping upper and lower jaws.

Longer Tool Life

This new speed wrench profile contacts the fasteners from their flats rather than edges, which provides balanced torque transmission and decreases stress accumulation on the edges increasing the tool life considerably.

- ☛ Fast drive without removing the wrench from the fastener.
- ☛ Firm torque transmission and longer life.



LOKMA VE BİJON ANAHTARLARI

SOCKETS AND RIM WRENCHES

Lokma Anahtarlar
Socket Wrenches

Lokma Takımları
Socket Wrench Sets

Kovan Anahtarlar
Tubular Socket Wrenches

Bijon Anahtarlar
Rim Wrenches

Tork Anahtarları
Torque Wrenches



Tork (Moment) ve Kuvvet / Torque (Moment) and Force

» Bilindiği üzere kuvvet bir cisme hareketini veren etkidir. Tork ise cismin bir kuvvet etkisinde döndürülmesidir. Bağlantı elemanlarını sıkma işlemlerinde genel olarak yıldız, çatal ya da lokma anahtar gibi çeşitli el aletleri kullanılır. Bu işlem fiziksel olarak işlevsel ve doğru olarak gözüke de vida, civata bağlantısının güvenilirliği açısından doğru bir çalışma şekli değildir. Bir vida-civata bağlantısının çözülmeye karşı en büyük emniyeti teorik olarak hesaplanmış olan tork değeri ile sıkılmasıdır. Bu da ancak çeşitli modern yöntemler ile sağlanabilir. Örneğin; tork anahtarı ile sıkmak, motor tahrikli sıkma işlemleri, ultrason ile sıkmak gibi. Çeşitli uygulamalar tork anahtarı kullanımının daha makul olduğunu göstermiştir.

» As you know, force is the effect which imparts movement to an object. Torque, is rotation of an object under effect of force. Various hand tools like a Philips head screwdriver, for spanner or socket wrench are used to tighten connection elements. While this process appears functional and correct, it is not an appropriate procedure for reliability of the threaded connection. The greatest safety of a threaded connection against loosening is being tightened at a certain torque level theoretically calculated beforehand. This can only be ensured with various modern methods. For example, tightening with a torque wrench, motor-driven tightening or ultrasound supported tightening. Various applications have shown that use of a torque wrench is more appropriate.



Sıkma Torku Nedir ?

» Sıkma torku, kuvvet etkisiyle döndürme kolunun uç kısmındaki anahtar ağzında oluşturulur ve birimi Nm'dir. Bu sıkma torku vida bağlantısında bir ön gerilme yaratır. Sıkma torkunun olması gerekenden düşük olması, zamanla oluşabilecek titreşimler sebebiyle vida-civata bağlantısında gevşeme/çözülmeye yol açabilir. Ön gerilme kuvveti fazlaca oluşan bağlantılarda ise parçalara zarar verebilir, aynı zamanda vida üzerindeki dişlerde meydana gelecek aşınmalar bağlantıyı çözülemeye kılabilir.

What Is Tightening Torque ?

» Tightening torque is generated at the wrench tip at the terminus of the rotating lever under the effect of force, and its unit is Nm. This tightening torque creates a pre-tension on the threaded connection. Tightening torque being lower than what is necessary can cause the threaded connection to loosen/unravel due to vibrations that might occur over time. On the other hand, pre-tension force being over what is necessary can cause damage on the connection parts, as well as causing the threads on the connection piece to wear off or causing the connection become non-severable.

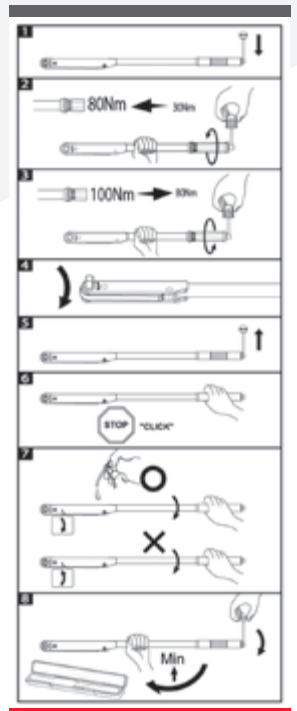

Tork Anahtarlarının Doğru Kullanımı

- » Tork anahtarı ile çalışılırken dikkat edilmesi gereken bazı hususlar bulunmaktadır. Bunlardan başlıcaları;
- Hangi tip tork anahtarı olursa olsun döndürme yönünün aksine kuvvet uygulanmaması gereklidir.
 - Cırcır anahtarlar gibi tork anahtarlarının da sökme işlemi için kullanılmaması gerekir.
 - Klik sesli modellerde klik sesi duyulduğu anda ayarlanmış tork değerine ulaşılmış demektir, daha fazla kuvvet uygulanmamalıdır.
 - Gövdesi hasar görmüş, mekanizması bozulmuş tork anahtarlarını kullanmaya devam etmeyiniz.
 - Kuvvet, tork anahtarının sap kısmından uygulanmalıdır.
 - Kullanımdan sonra nemden ve kirden korumak için her zaman kutusunda muhafaza ediniz.
 - Her kullanımdan sonra tork anahtarındaki yükü "0 Nm" konumuna getiriniz.
 - Tork anahtarlarını kendi başınıza tamir etmeye çalışmayınız.



Tork Anahtarlarının Kalibrasyonu

- » Tork anahtarlarının doğru çalışması ve bağlantıların sağlıklı sıkılabilmesi için kalibrasyon işlemi büyük önem arz etmektedir. TS EN ISO 6789-1 Standardına göre tork anahtarlarının ilk kullanımdan itibaren geçerli olmak üzere 12 aylık bir periyotta veya her 5000 kullanımlık çevrim sonunda kalibre edilmesi önerilmektedir.

Calibration Of Torque Wrenches

- » Calibration process carries great importance for torque wrenches to function correctly and be able to tighten connections in a healthy fashion. TS EN ISO 6789-1 Standard stipulates torque wrenches should be calibrated with 12 month periods or after each cycle of 5000 uses starting from the first use.

Correct Use Of Torque Wrenches

- » There are some important points that must be kept in mind when working with a torque wrench. Some of these include the following.
- No matter which type of torque wrench is used, force should not be applied at the opposite of rotating direction.
 - Torque wrenches like ratchet wrenches should not be used to loosen connections.
 - In models with click sound option, the click indicates the set torque value is achieved and further force should not be applied from then on.
 - Do not continue using torque wrenches with a damaged body or mechanism.
 - Force should be applied at the handle part of the torque wrench.
 - The tool should always be kept in its box after use to protect against moisture and dirt.
 - The load set of the torque wrench should be adjusted to "0 Nm" after each use.
 - Please do not attempt to repair torque wrenches on your own.

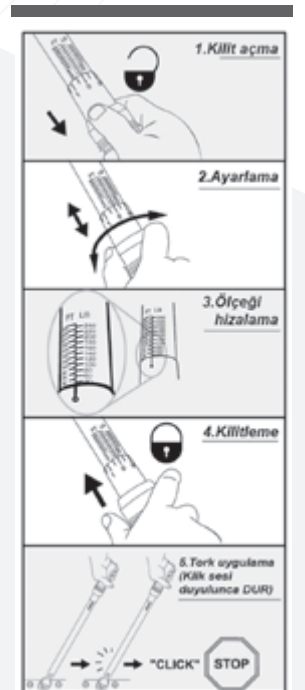

Nikel üzeri krom kaplama ile korozyon direncinde üst seviye koruma
Corrosion protection with nickel over chrome plating

Yüksek dayanım için üst toleranslarda tasarım
Improved durability with upper tolerance thickness

En uygun temas yüzeyi için hassas dövülmüş altı köşe ağızlar
Precise forged hex shape for best contact area



Bilya toplama yuvalı hassas işlenmiş kare kanal
Precise machined square adapter with ball stopper Groove

Yüksek mukavemetli alaşımlı sıcak dövme çeliği
High strength alloyed forged steel

Extra sürtünme kabiliyeti için tırtıklı tasarım
Extra friction capability with knurled design



1107

1/4" Altı Köşe Lokma Anahtar (mm)
Socket Wrench 6 Points (mm)

TS ISO 2725 -1
DIN 3124

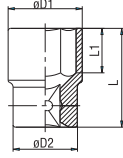

1/4"

Krom vanadyum, Krom kaplı
Chrom vanadium, Chrom plated

KOD CODE	mm	ø D1 mm	ø D2 mm	L mm	L1 mm	g	TL/ Ad.	
1107 06 0004	4	6.8	11.8	25	4	10	10	26,25
1107 06 0045	4.5	7.4	11.8	25	5	10	10	26,25
1107 06 0005	5	8	11.8	25	6	10	10	26,25
1107 06 0055	5.5	8.5	11.8	25	6	10	10	26,25
1107 06 0006	6	9.2	11.8	25	7	10	10	26,25
1107 06 0007	7	10.8	11.8	25	7	10	10	26,25
1107 06 0008	8	11.9	11.8	25	8	10	10	26,25
1107 06 0009	9	12.9	12.8	25	8	15	10	28,50
1107 06 0010	10	14.3	14.3	25	9	20	10	28,50
1107 06 0011	11	15.8	15.8	25	9	20	10	36,00
1107 06 0012	12	16.8	16.8	25	9	25	10	36,00
1107 06 0013	13	17.8	17.8	25	9	30	10	41,25

1107

1/4" Altı Köşe Derin Lokma Anahtar (mm)
Deep Socket Wrench 6 Points (mm)

TS ISO 2725 -1

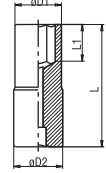

1/4"

Krom vanadyum, Krom kaplı
Chrom vanadium, Chrom Plated

KOD CODE	mm	ø D1 mm	ø D2 mm	L mm	L1 mm	g	TL/ Ad.	
1107 06 4004	4	6.8	11.8	50	6	10	10	50,50
1107 06 4005	5	8	11.8	50	7	20	10	50,50
1107 06 4055	5.5	8.7	11.8	50	9	20	10	50,50
1107 06 4006	6	9.2	11.8	50	9	25	10	57,00
1107 06 4007	7	10.8	11.8	50	15	25	10	57,00
1107 06 4008	8	11.8	11.8	50	15	25	10	57,00
1107 06 4009	9	13	13	50	15	30	10	61,00
1107 06 4010	10	14.5	14.5	50	15	40	10	61,00
1107 06 4011	11	15.8	15.8	50	21	45	10	65,50
1107 06 4012	12	16.8	16.8	50	21	50	10	65,50
1107 06 4013	13	17.8	17.8	50	21	55	10	65,50

1107 00 6014

1/4" Altı Köşe Derin Lokma Anahtar Set (14 parça, mm)
Deep Socket Wrench Set Type 6 Points (14 pcs, mm)



1/4"

KOD CODE	LOKMALAR Sockets	AVADANLIKLAR Accessories	g	TL/Ad.
1107 00 6014	4-5-5,5-6 7-8-9-10 11-12-13 Altı Köşe Derin Lokma Wrench 6 Points	1/4" Cırcır Kol Ratchet Handle 1/4" Ara Kol Extension Bar 50 mm 1/4" Ara Kol Extension Bar 100 mm	1005	14 1.252,00



1107

1/4" Lokmalı Allen Uç
Hexagonal Bit
Socket Wrench



1/4"

Krom vanadyum, Krom Kaplı
Chrom vanadium, Chrom Plated

KOD CODE	mm	L mm	g		TL/ Ad.
1107 06 1125	2.5	37	13	10	44,50
1107 06 1103	3	37	13	10	44,50
1107 06 1104	4	37	15	10	44,50
1107 06 1105	5	37	15	10	44,50
1107 06 1106	6	37	15	10	44,50
1107 06 1107	7	37	16	10	52,50
1107 06 1108	8	37	17	10	52,50
1107 06 1110	10	37	19	10	63,00

1107

1/4" Lokmalı Star Delikli (Torx®) Uç
Tamper Resistant Torx
Bit Socket Wrench



1/4"

Krom vanadyum, Krom Kaplı
Chrom vanadium, Chrom Plated

KOD CODE		L mm	g		TL/ Ad.
1107 06 1308	TR8	37	13	10	53,75
1107 06 1309	TR9	37	13	10	53,75
1107 06 1310	TR10	37	13	10	53,75
1107 06 1315	TR15	37	14	10	53,75
1107 06 1320	TR20	37	14	10	53,75
1107 06 1325	TR25	37	14	10	53,75
1107 06 1327	TR27	37	14	10	53,75
1107 06 1330	TR30	37	15	10	53,75
1107 06 1340	TR40	37	16	10	62,25

1107

1/4" Lokmalı Star (Torx®) Uç
Torx Bit Socket Wrench



1/4"

Krom vanadyum, Krom Kaplı
Chrom vanadium, Chrom Plated

KOD CODE		L mm	g		TL/ Ad.
1107 06 1208	T8	37	12	10	46,00
1107 06 1209	T9	37	12	10	46,00
1107 06 1210	T10	37	13	10	46,00
1107 06 1215	T15	37	14	10	46,00
1107 06 1220	T20	37	14	10	46,00
1107 06 1225	T25	37	14	10	46,00
1107 06 1227	T27	37	14	10	46,00
1107 06 1230	T30	37	15	10	46,00
1107 06 1240	T40	37	16	10	46,00

1107

1/4" Lokmalı Düz Uç
Slotted Bit Socket Wrench



1/4"

Krom vanadyum, Krom Kaplı
Chrom vanadium, Chrom Plated

KOD CODE		L mm	g		TL/ Ad.
1107 06 1403	3	37	13	10	44,50
1107 06 1435	3.5	37	14	10	44,50
1107 06 1404	4	37	14	10	44,50
1107 06 1445	4.5	37	14	10	44,50
1107 06 1455	5.5	37	15	10	44,50
1107 06 1465	6.5	37	15	10	44,50
1107 06 1407	7	37	16	10	44,50
1107 06 1408	8	37	16	10	57,75
1107 06 1410	10	37	17	10	62,25

1107
**1/4" Lokmalı Yıldız Uç
Phillips Bit Socket
Wrench**

1/4"
**Krom vanadyum, Krom Kaplı
Chrom vanadium, Chrom Plated**

KOD CODE	+	L mm	g	□	TL/Ad.
1107 06 1501	Ph 1	37	14	10	44,50
1107 06 1502	Ph 2	37	14	10	44,50
1107 06 1503	Ph 3	37	15	10	44,50
1107 06 1504	Ph 4	37	16	10	44,50

1107 00 1042
**1/4" Bits Uçlu Lokma Set (42 Parça)
Bit Socket Wrench Set (42 Pcs)**

1/4"

KOD CODE	İÇERİK CONTENTS	□	TL/Ad.
1107 00 1042	1/4" Lokmalı Star Torx® Uçlar Torx® Bit Socket T8-T9-T10-T15-T20-T25-T27-T30-T40	42	2.591,50
	1/4" Lokmalı Star Delikli Torx® Uçlar Tamper Resistant Torx® Bit Socket Wrench TR8-TR9-TR10-TR15-TR20-TR25-TR27 TR30-TR40		
	1/4" Lokmalı Allen Uçlar Hexagonal Bit Socket Wrench 2.5-3-4-5-6-7-8-10		
	1/4" Lokmalı Düz Uç Slotted Bit Socket Wrench 3-3.5-4-4.5-5.5 6.5-7-8-10		
	1/4" Lokmalı Yıldız Uç Phillips Bit Socket Wrench Ph1-Ph2-Ph3-Ph4		
	1/4" Cırcır kolu Ratchet Handle		
	1/4" Ara Kol Extension Bar 100 mm		
	1/4" Lokma Tornavida Adaptörü Spindle Handle		

1507
**1/4" Ara Kol
Extension Bar**

 TS ISO 3316
DIN 3123

1/4"
**Krom vanadyum, Krom kaplı
Chrom vanadium, Chrom plated**

KOD CODE	L mm	g	□	TL/Ad.
1507 06 0050	50	25	5	66,50
1507 06 0100	100	45	5	71,75

1507 06 3150
**1/4" Ara Kol Flexible
Flexible Extension**

1/4"
**Krom vanadyum, Krom kaplı
Chrom vanadium, Chrom plated**

KOD CODE	L mm	g	□	TL/Ad.
1507 06 3150	150	70	5	292,00

1507 06 0038
**1/4" Mafsal
Universal Joint**

TS ISO 3316

1/4"
**Krom vanadyum, Krom kaplı
Chrom vanadium, Chrom plated**

KOD CODE	L mm	g	□	TL/Ad.
1507 06 0038	38	25	5	121,50

1507 06 4115
**1/4" T Kol
Sliding T - Handle**

 TS ISO 3315
DIN 3122

1/4"
**Krom vanadyum, Krom kaplı
Chrom vanadium, Chrom plated**

KOD CODE	L mm	g	□	TL/Ad.
1507 06 4115	115	45	5	119,00

1507 06 2140

1/4" Cırcır Kolu (45 Diş)
Ratchet Handle (45 Teeth)

TS ISO 3315



1/4"

Krom vanadyum, Krom kaplı
Chrom vanadium, Chrom plated

KOD CODE	L mm	g		TL/Ad.
1507 06 2140	140	140	5	472,75

1507 06 6140

1/4" Mandallı Cırcır Kolu (24 Diş)
Ratchet With Latch (24 Teeth)

TS ISO 3315



1/4"

Krom vanadyum, Krom kaplı
Chrom vanadium, Chrom plated

KOD CODE	L mm	g		TL/Ad.
1507 06 6140	140	140	5	676,75

1507 06 2150

1/4" Mafsallı Cırcır Kolu (72 Diş)
Swivel Head Ratchet (72 Teeth)



1/4"

Krom vanadyum, Krom kaplı
Chrom vanadium, Chrom plated

KOD CODE	L mm	g		TL/Ad.
★ 1507 06 2150	150	130	5	1.568,00

1507 06 2110

1/4" Lokma/Bits Tutuculu Cırcır Kolu (72 Diş)
Socket/Bit Holder mini Ratchet (72 Teeth)



1/4"

Krom vanadyum, Krom kaplı
Chrom vanadium, Chrom plated

KOD CODE	L mm	g		TL/Ad.
★ 1507 06 2110	110	100	5	984,25

1507 06 7115

1/4" Mafsallı T Kol Cırcır Kolu (72 Diş)
Swivel Head, T Handle Ratchet (72 Teeth)



1/4"

Krom vanadyum, Krom kaplı
Chrom vanadium, Chrom plated

KOD CODE	L mm	g		TL/Ad.
★ 1507 06 7115	115	110	5	1.506,50

1507 06 0004

1/4" Lokma Adaptörü
Adapter

TS ISO 3316
DIN 3123



1/4"

Krom vanadyum, Krom kaplı
Chrom vanadium, Chrom plated

KOD CODE	inch	g		TL/Ad.
1507 06 0004	1/4"Fx3/8"M	20	5	61,25

1507 06 4080

1/4" Derin Lokma Tornavida Adaptörü
Spindle Handle

TS ISO 3315
DIN 3122

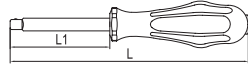

1/4"

Krom vanadyum, Krom kaplı, Selüloz Asetat Saplı
Chrom vanadium, Chrom plated, Cellulose Acetate Handle

KOD CODE	L mm	L1 mm	g		TL/Ad.
1507 06 4080	150	65	100	10	140,75

1107 06 5010

1/4" Bits Tutucu Lokma (Mıknatıslı)
Bit Holder Socket



1/4"

Krom vanadyum
Chrom vanadium

KOD CODE	Inch	g		TL/Ad.
1107 06 5010	1/4" F - 1/4" F	15	5	98,00

1107 00 6015

1/4" Altı Köşe Lokma Anahtar Takımı (15 parça, mm)
Socket Wrench Set 6 Points (15 pcs, mm)



1/4"

KOD CODE	LOKMALAR Sockets	AVADANLIKLAR Accessories	g		TL/Ad.
1107 00 6015		1/4" Cırcır kolu Ratchet Handle	960	15	1.153,00
	4 - 5 - 6	1/4" Mafsals Universal Joint			
	7 - 8 - 9 - 10	1/4" T Kol Sliding T Handle			
	11 - 12 - 13	1/4" Ara Kol Extension Bar 50 mm			
	Altı Köşe Six Points	1/4" Ara Kol Extension Bar 100 mm			



14000 005131

1/4" Altı Köşe Lokma Anahtar ve Bits Set (48 parça, mm)
Socket Wrench 6 Points and Bits Set (48 Pcs, mm)



1/4"

KOD CODE	LOKMALAR Sockets	AVADANLIKLAR Accessories	g	TL/Ad.
14000 005131	4 - 4.5 - 5 5.5 - 6 - 7 - 8 9 - 10 - 11 - 12 13 - 14 Altı Köşe Lokma Anahtar Six Points	1/4" Cırcır kolu Ratchet Handle 1/4" Mafsalsal Universal Joint 1/4" Ara Kol Extension Bar 50 -100 mm 1/4" Bits Tutucu Lokma Bits Holder Socket 1/4" Derin Lokma Tornavida Adaptörü Spindle Handle	1450 48	3.067,25
	4 - 4.5 - 5 5.5 - 6 - 7 - 8 9 - 10 - 11 - 12 13 - 14 Altı Köşe Derin Lokma Anahtar Six Points Deep	SL3 - SL4,5 - SL5 SL6.5 - SL8 PH0 - PH1 - PH2 PH3 H3 - H4 - H5 - H6 H7 - H8 - H10		

14000 005132

1/4" Altı Köşe Lokma Anahtar ve Bits Set (27 parça, mm)
Socket Wrench 6 Points and Bits Set (27 Pcs, mm)



1/4"

KOD CODE	LOKMALAR Sockets	AVADANLIKLAR Accessories	g	TL/Ad.
14000 005132	4 - 4.5 - 5 5.5 - 6 - 7 - 8 9 - 10 - 12 13 - 14 Altı Köşe Lokma Anahtar Six Points	1/4" Cırcır Kolu Ratchet Handle 1/4" Mafsalsal Universal Joint 1/4" Ara Kol Extension Bar 100 mm 1/4" Bits Tutucu Lokma Bits Holder Socket	590 27	1.336,50
		PH1 - PH2 H3 - H4 - H5 T10 - T15 - T20 T25 - T30 - T40		

14000 005133

1/4" Altı Köşe Lokma Anahtar ve Bits Set (45 parça, mm)
Socket Wrench 6 Points and Bits Set (45 Pcs, mm)



1/4"

KOD CODE	LOKMALAR Sockets	AVADANLIKLAR Accessories	g	TL/Ad.
14000 005133	4 - 5 5.5 - 6 - 7 - 8 9 - 10 - 11 - 12 13 - 14 Altı Köşe Lokma Anahtar Six Points	1/4" Cırcır kolu Ratchet Handle 1/4" Mafsalsal Universal Joint 1/4" Ara Kol Extension Bar 50 mm 1/4" Bits Tutucu Lokma Bits Holder Socket 1/4" Derin Lokma Tornavida Adaptörü Spindle Handle 1/4" Arakol Flexible Flexible Extension	1000 45	1.961,50
		SL4.5 - SL6.5 SL7 - SL8 PH1 - PH2 - PH3 PZ1 - PZ2 - PZ3 H2.5 - H3 - H4 - H5 H6 - H7 - H8 - H10 T8U - T9U - T10U T15U - T20U - T25U T27U - T30U - T40U		

Havali aletler ile kullanmayınız / Do not use with power-tools

1110

3/8" Altı Köşe Lokma Anahtar (mm)
Socket Wrench 6 Points (mm)

TS ISO 2725 - 1
DIN 3124

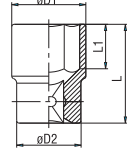

3/8"

Krom vanadyum, Krom kaplı
Chrom vanadium, Chrom plated

KOD CODE	mm	$\phi D1$ mm	$\phi D2$ mm	L mm	L1 mm	g		TL/Ad.
1110 06 0006	6	9.8	17.8	27	9	25	10	67,50
1110 06 0007	7	10.8	17.8	27	9	25	10	67,50
1110 06 0008	8	12	17.8	27	9	25	10	67,50
1110 06 0009	9	13.2	17.8	27	9	25	10	67,50
1110 06 0010	10	14.5	17.8	27	9	25	10	67,50
1110 06 0011	11	15.8	17.8	27	9	30	10	67,50
1110 06 0012	12	16.8	17.8	27	9	30	10	67,50
1110 06 0013	13	17.8	16.8	27	9	30	10	71,75
1110 06 0014	14	19.6	17.5	29	11	35	10	71,75
1110 06 0015	15	20.8	18	29	11	45	10	71,75
1110 06 0016	16	21.8	19	29	11	45	10	74,75
1110 06 0017	17	23.4	20	29	11	55	10	74,75
1110 06 0018	18	24.7	21	29	13	60	10	78,00
1110 06 0019	19	25.8	22	29	13	65	10	89,75
1110 06 0021	21	27.8	24	32	13	80	10	101,25
1110 06 0022	22	29.7	26	32	15	85	10	108,25
1110 06 0023	23	29.7	26	32	15	90	10	108,25

1110 06 9208

3/8" Buji Lokma Anahtar (Lastikli)
Spark Plug Socket with Rubber



3/8"

Krom vanadyum, Krom kaplı
Chrom vanadium, Chrom plated

KOD CODE	mm	L mm	g		TL/Ad.
1110 06 9208	20.8	70	145	10	144,00

3/8" Altı Köşe Derin Lokma Anahtar (mm)
Deep Socket Wrench 6 Points (mm)

TS ISO 2725 - 1
DIN 3124



3/8"

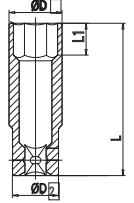

Krom vanadyum, Krom kaplı
Chrom vanadium, Chrom plated

KOD CODE	mm	$\phi D1$ mm	$\phi D2$ mm	L mm	L1 mm	g		TL/Ad.
14000 004965	6	9.9	17.8	63	10	50	10	126,00
14000 004966	7	10.8	17.8	63	12	50	10	126,00
14000 004967	8	12	17.8	63	12	50	10	126,00
14000 004968	9	13.2	17.8	63	12	55	10	126,00
14000 004969	10	14.5	17.8	63	12	60	10	126,00
14000 004970	11	15.8	17.8	63	15	60	10	126,00
14000 004971	12	16.8	17.8	63	15	70	10	126,00
14000 004972	13	17.8	16.8	63	15	65	10	129,75
14000 004973	14	19.7	18	63	16	80	10	129,75
14000 004974	15	20.8	18	63	18	75	10	129,75
14000 004975	16	21.8	19	63	18	85	10	129,75
14000 004976	17	23.8	20	63	18	100	10	174,00
14000 004977	18	24.7	21	63	20	110	10	174,00
14000 004978	19	25.8	21	63	20	110	10	178,00
14000 004980	21	27.8	25	63	20	140	10	203,75
14000 004981	22	29.7	26	63	20	170	10	240,50

3/8" Star (Torx®) Anahtar
Star Torx® Socket Wrench



3/8"

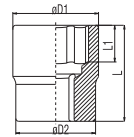

Krom vanadyum, Krom kaplı
Chrom vanadium, Chrom plated

KOD CODE		$\phi D1$ mm	$\phi D2$ mm	L mm	L1 mm	g		TL/Ad.
14000 005001	E4	6	16.8	28	3.6	20	10	95,75
14000 005002	E5	7	16.8	28	4	20	10	95,75
14000 005003	E6	8	16.8	28	5	20	10	95,75
14000 005004	E7	9	16.8	28	6	20	10	95,75
14000 005005	E8	10	16.8	28	6.5	25	10	95,75
14000 005006	E10	12	16.8	28	7	25	10	95,75
14000 005007	E11	12.8	16.8	28	8	25	10	95,75
14000 005008	E12	14.3	16.8	28	9	25	10	95,75
14000 005009	E14	15.9	17.8	28	9.5	30	10	95,75
14000 005010	E16	18	19.8	28	10.5	40	10	99,00
14000 005011	E18	20	21.8	28	11	55	10	102,00

3/8" Lokmalı Allen Uç (mm)
Hexagonal Bits Socket Wrench



3/8"

Krom vanadyum, Krom kaplı
Chrom vanadium, Chrom plated

KOD CODE	mm	L mm	g		TL/ Ad.
14000 004993	3	50	30	10	120,25
14000 004994	4	50	35	10	120,25
14000 004995	5	50	35	10	120,25
14000 004996	6	50	35	10	120,25
14000 004997	7	50	40	10	130,00
14000 004998	8	50	40	10	130,00
14000 004999	9	50	45	10	152,00
14000 005000	10	50	50	10	152,00

3/8" Lokmalı Star (Torx®) Uç
Star Torx® Bits Socket Wrench



3/8"

Krom vanadyum, Krom kaplı
Chrom vanadium, Chrom plated

KOD CODE		L mm	g		TL/ Ad.
14000 004983	T8	50	30	10	105,75
14000 004984	T9	50	30	10	105,75
14000 004985	T10	50	35	10	120,25
14000 004986	T15	50	35	10	120,25
14000 004987	T20	50	35	10	120,25
14000 004988	T25	50	35	10	120,25
14000 004989	T27	50	35	10	120,25
14000 004990	T30	50	35	10	120,25
14000 004991	T40	50	35	10	120,25
14000 004992	T45	50	40	10	137,50

1510 06 0200

3/8" Cırcır Kolu (32 Diş)
Ratchet Handle (32 Teeth)

TS ISO 3315
DIN 3122



3/8"

Krom vanadyum, Krom kaplı
Chrom vanadium, Chrom plated

KOD CODE	L mm	g		TL/ Ad.
1510 06 0200	200	295	5	800,75

1510

3/8" Ara Kol
Extension Bar

TS ISO 3316
DIN 3123



3/8"

Krom vanadyum, Krom kaplı
Chrom vanadium, Chrom plated

KOD CODE	L mm	g		TL/ Ad.
1510 06 0075	75	75	5	122,00
1510 06 0150	150	145	5	184,25

1510 06 0056

3/8" Mafsal
Universal Joint

TS ISO 3316
DIN 3123



3/8"

Krom vanadyum, Krom kaplı
Chrom vanadium, Chrom plated

KOD CODE	L mm	g		TL/ Ad.
1510 06 0056	56.5	60	5	197,50

1510 06 1200
3/8" T Kol
Sliding T - Handle

 TS ISO 3315
DIN 3122

3/8"

 Krom vanadyum, Krom kaplı
Chrom vanadium, Chrom plated

KOD CODE	L mm	g		TL/Ad.
1510 06 1200	200	180	5	284,00

1510 06 0007
3/8" Lokma Adaptörü
Adapter

 TS ISO 3316
DIN 3123

3/8"

 Krom vanadyum, Krom kaplı
Chrom vanadium, Chrom plated

KOD CODE	inch	g		TL/Ad.
1510 06 0007	3/8"Fx1/2"M	45	5	136,00

1110 00 6019
3/8" Altı Köşe Lokma Anahtar Takımı (19 parça, mm)
6 Points Socket Wrench Set (19 Pcs, mm)

3/8"

KOD CODE	LOKMA LAR Sockets	AVADAN LIKLAR Accessories	g		TL/Ad.
1110 00 6019	6 - 7 - 8 - 9 10 - 11 - 12 13 - 14 - 17 19 - 21 - 23 Altı Köşe Six Points 20.8 Buji Lokma Lastikli Altı Köşe Spark Plug Socket With Rubber	3/8" Cırcır Kolu Ratchet Handle 3/8" Mafsal Universal Joint 3/8" T Kol Sliding T Handle 3/8" Ara Kol Extension Bar 75 mm 3/8" Ara Kol Extension Bar 150 mm	1089	19	2.722,50

14000 005134
3/8" Altı Köşe Lokma Anahtar Set (24 parça, mm)
Socket Wrench Set 6 Points (24 Pcs, mm)

YENİ NEW

3/8"

KOD CODE	LOKMA LAR Sockets	AVADAN LIKLAR Accessories	g		TL/Ad.
14000 005134	7 - 8 - 9 10 - 11 - 12 13 - 14 - 15 16 - 17 - 19 Altı Köşe Six Points 8 - 10 - 11 12 - 13 - 14 16 - 17 - 19 Altı Köşe Derin Six Points Deep	3/8" Cırcır Kolu Ratchet Handle 3/8" Mafsal Universal Joint 3/8" Ara Kol Extension Bar 75 mm	2010	24	3.548,00

14000 005135
3/8" Altı Köşe Lokma Anahtar & Lokma Allen Set (35 parça, mm)
Socket Wrench Set 6 Points and Hexagonal Bit Socket Wrench Set (35 Pcs, mm)

3/8"
YENİ NEW

KOD CODE	LOKMA LAR Sockets	AVADAN LIKLAR Accessories	g		TL/Ad.
14000 005135	6 - 7 - 8 - 9 10 - 11 - 13 14 - 17 - 19 Altı Köşe Six Points E4 - E5 - E6 E7 - E8 - E10 E12 - E14 - E16 E18 Star (Torx) Lokma Anahtar Torx Socket Wrench	3/8" Cırcır Kolu Ratchet Handle 3/8" Mafsal Universal Joint 3/8" Ara Kol Extension Bar 75 mm - 150 mm 3/8" T Kol Sliding T Handle H3 - H4 - H5 - H6 - H8 Lokma Allen Uç Hexagonal Bit Socket T20 - T25 - T27 T30 - T40 Lokmalı Star (Torx®) Uç	2240	35	3.202,00

1113 00 6145

1/2" Lokma Anahtar Sehpası (145 Parça)
Display Frame for Sockets (145 Pcs)



1/2"

KOD CODE	İÇERİK CONTENTS	g	TL/Ad.
1113 00 6145	Dolu/Full 10-11-12-13-14-15-16-17-18-19 10 adet /10 Pcs 21-22-23-24-26-27-28-30-32 5 Adet / 5 Pcs	18.236	1 20.132,50

1113

1/2" Altı Köşe Lokma Anahtar (mm)
Socket Wrench 6 Points (mm)



TS ISO 2725-1
DIN 3124



1/2"

Krom vanadyum, Krom kaplı
Chrom vanadium, Chrom plated

KOD CODE	mm	σ D1 mm	σ D2 mm	L mm	L1 mm	g	TL/Ad.
1113 06 1008	8	14	22	38	7	55	10 86,25
1113 06 1009	9	14.1	22	38	7	55	10 86,25
1113 06 1010	10	15.4	22	38	8	55	10 107,25
1113 06 1011	11	16.6	22	38	8	60	10 107,25
1113 06 1012	12	17.8	22	38	9	60	10 107,25
1113 06 1013	13	19	22	38	10	65	10 115,25
1113 06 1014	14	20.4	22	38	11	65	10 115,25
1113 06 1015	15	21.6	22	38	11	65	10 115,25
1113 06 1016	16	22.9	22	38	11	70	10 120,75
1113 06 1017	17	24	22	38	12	70	10 120,75
1113 06 1018	18	25.4	23	38	13	75	10 120,75
1113 06 1019	19	26.6	23	38	13	75	10 126,00
1113 06 1020	20	28	24	38	13	80	10 126,00
1113 06 1021	21	29.2	24	38	13	85	5 126,00
1113 06 1022	22	30.4	26	38	15	95	5 126,00
1113 06 1023	23	31.2	28	38	15	100	5 131,25
1113 06 1024	24	32.9	28	38	17	115	5 131,25
1113 06 1025	25	33.2	29	42	17	125	5 131,25
1113 06 1026	26	34	30	42	17	135	5 131,25
1113 06 1027	27	36.6	30	42	19	140	5 150,25
1113 06 1028	28	37.5	30	42	20	160	5 150,25
1113 06 1029	29	39.5	32	42	21	170	5 158,25
1113 06 1030	30	40	32	44	21	180	5 158,25
1113 06 1032	32	43	34	44	23	190	5 164,75

Havali aletler ile kullanmayınız / Do not use with power-tools

1000V 1/2" Altı Köşe Lokma Anahtar (mm)
Socket Wrench 6 Points 1000V (mm)

TS ISO 2725-1
DIN 3124
△ 1000 V
IEC 60900



1/2"

Krom vanadyum, Krom kaplı
Chrom vanadium, Chrom plated

KOD CODE	mm	σ D1 mm	σ D2 mm	L mm	L1 mm	g	TL/Ad.
13000 005148	10	19.5	27	40	7	55	1 449,50
13000 005149	11	20.7	27	40	7	55	1 447,00
13000 005150	12	22	27	40	8	55	1 455,00
13000 005151	13	23.2	27	40	8	60	1 457,00
13000 005152	14	24.5	27	40	9	60	1 460,50
13000 005153	15	25.7	27	40	10	65	1 463,00
13000 005154	16	27	27	40	11	65	1 472,00
13000 005155	17	28.2	27	40	11	65	1 478,00
13000 005156	19	30.7	27	42	11	70	1 488,25
13000 005157	22	34.5	27	44	12	70	1 500,25
13000 005158	24	37	27	46	13	75	1 510,50
13000 005159	27	40.7	27	48	13	75	1 602,00

1113

1/2" Buji Lokma Anahtar (Lastikli)
Spark Plug Socket with Rubber



1/2"

Krom vanadyum, Krom kaplı
Chrom vanadium, Chrom plated

KOD CODE	mm	L mm	g	TL/Ad.
1113 06 9160	16	70	80	10 154,75
1113 06 9208	21	70	155	10 199,50

1114
1/2" Oniki Köşe Lokma Anahtar (mm)
 Socket Wrench 12 Points (mm)

 TS ISO 2725 - 1
 DIN 3124

1/2"

 Krom vanadyum, Krom kaplı
 Chrom vanadium, Chrom plated

KOD CODE	Ø mm	σ D1 mm	σ D2 mm	L mm	L1 mm	g	TL/ Ad.
1114 06 1010	10	15	23.3	38	8	60	10 107,50
1114 06 1011	11	16.4	23.3	38	8	60	10 107,50
1114 06 1012	12	17.8	23.3	38	9	60	10 107,50
1114 06 1013	13	19	23.3	38	10	60	10 116,25
1114 06 1014	14	20.4	23.3	38	11	60	10 116,25
1114 06 1015	15	21.6	23.3	38	11	65	10 116,25
1114 06 1016	16	22.9	24	38	11	70	10 121,00
1114 06 1017	17	24	22.5	38	12	70	10 121,00
1114 06 1018	18	25.2	23	38	13	70	10 121,00
1114 06 1019	19	26.8	23	38	13	75	10 127,00
1114 06 1020	20	28	23	38	13	80	10 127,00
1114 06 1021	21	29.2	23	38	13	80	5 127,00
1114 06 1022	22	30.2	24	40	15	95	5 127,00
1114 06 1023	23	31.4	25	40	15	100	5 131,75
1114 06 1024	24	32.6	26	42	17	105	5 131,75
1114 06 1026	26	35.3	28	42	17	135	5 148,50
1114 06 1027	27	36.6	28	42	19	135	5 169,75
1114 06 1028	28	37.8	30	42	20	155	5 169,75
1114 06 1030	30	40	30	44	21	165	5 178,00
1114 06 1032	32	42.5	30	44	23	180	5 186,75

1413
1/2" Oniki Köşe Lokma Anahtar (SAE)
 Socket Wrench 12 Points (SAE)

1/2"

 Krom vanadyum, Krom kaplı
 Chrom vanadium, Chrom plated

KOD CODE	Ø inch	σ D1 mm	σ D2 mm	L mm	L1 mm	g	TL/ Ad.
1413 06 1008	5/16"	13.2	21.8	37	6	45	10 125,50
1413 06 1095	3/8"	15	21.8	37	8	50	10 125,50
1413 06 1010	7/16"	16.4	23.3	37	9	60	10 130,00
1413 06 1011	15/32"	18	23.3	37	9	60	10 130,00
1413 06 1012	1/2"	19	23.3	37	9	60	10 135,25
1413 06 1013	9/16"	20.4	23.3	37	11	60	10 139,75
1413 06 1014	19/32"	21.6	23.3	37	11	65	10 139,75
1413 06 1015	5/8"	23.1	22	38	11	70	10 141,50
1413 06 1016	11/16"	24.5	22.5	38	11	70	10 146,50
1413 06 1017	3/4"	26.8	23	38	13	75	10 147,75
1413 06 1020	25/32"	28	23	38	13	75	10 153,00
1413 06 1021	13/16"	28.6	23	38	13	80	10 153,00
1413 06 1022	7/8"	30.2	24	40	15	90	5 153,00
1413 06 1024	15/16"	32.6	26	42	17	115	5 159,25
1413 06 1025	1"	35	28	42	17	130	5 159,25
1413 06 1027	1 1/16"	36.6	28	42	19	135	5 209,00
1413 06 1029	1 1/8"	38.8	30	42	19	170	5 209,00
1413 06 1030	1 3/16"	40	29.5	44	20	170	5 209,00
1413 06 1032	1 1/4"	42.5	30	44	22	185	5 209,00

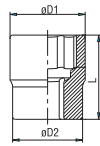
14000 005130
1/2" Twist Lokma Anahtar Set (10 parça, mm)
 Twist Socket Wrench Set (10 Pcs,mm)

1/2"

 Krom molibden, Fosfat kaplamalı
 Chrom molybdenum, Phosphate finish

KOD CODE	mm	σ D1 mm	σ D2 mm	L mm	Ad. Boy	g	TL/Ad.
	10	16	22	34	-		1
	11	17.5	22	34	-		1
	12	18.5	22	34	-		1
	13	20.4	22	34	-		1
	14	21.5	25	34	-		1
14000 005130	15	22.5	25	34	-	790	1 3.855,75
	16	23.5	25	34	-		1
	17	25.8	25	34	-		1
	19	28.7	27	34	-		1
	Adaptör / Adapter					80	1

**YENİ
NEW**

Havalı aletler ile kullanmayınız / Do not use with power-tools

1108

1/2" Altı Köşe Derin Lokma Anahtar (mm)
Deep Socket Wrench 6 Points (mm)

TS ISO 2725 - 1
DIN 3124

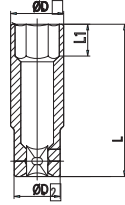

Krom vanadyum, Krom kaplı
Chrom vanadium, Chrom plated



KOD CODE	Ø mm	ØD1 mm	ØD2 mm	L mm	L1 mm	g	TL/ Ad.
1108 06 0010	10	15,2	22	75	6	110	10 200,75
1108 06 0011	11	16,7	24	75	7	110	10 200,75
1108 06 0012	12	18	24	75	8	110	10 200,75
1108 06 0013	13	19	24	75	8	120	10 215,00
1108 06 0014	14	20,5	24	75	10	120	10 215,00
1108 06 0015	15	21,7	24	75	10	140	10 215,00
1108 06 0016	16	22	25,5	75	10	140	10 225,00
1108 06 0017	17	24	25,5	75	10	140	10 225,00
1108 06 0018	18	25,5	25,5	75	12	150	10 225,00
1108 06 0019	19	26	26,7	75	12	150	10 235,50

1108 00 6010

1/2" Altı Köşe Derin Lokma Anahtar Takımı (10 parça mm)
Deep Socket Set (10 pcs. mm)



KOD CODE	İÇERİK CONTENTS	g	TL/ Ad.
1108 00 6010	10-11-12-13-14-15 16-17-18-19	1290	10 2.157,75

1113

1/2" Star (Torx®) Lokma Anahtar
Star Torx® Socket Wrench

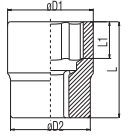

Krom vanadyum, Krom kaplı
Chrom vanadium, Chrom plated



KOD CODE	Ø D1 mm	Ø D2 mm	L mm	L1 mm	g	TL/ Ad.
1113 06 0210	E10	13.2	23.8	37	7.5	60 10 103,25
1113 06 0212	E12	15	23.8	37	9	65 10 103,25
1113 06 0214	E14	16.4	23.8	37	10	65 10 103,25
1113 06 0216	E16	18.8	23.8	37	11	70 10 103,25
1113 06 0218	E18	20.5	23.8	39	12.5	75 10 103,25
1113 06 0220	E20	23	23.8	39	14	75 10 116,25

1113 00 6007

1/2" Star (Torx®) Lokma Anahtar Takımı (7 Parça)
Star Torx® Socket Wrench Set (7 Pcs)



KOD CODE	İÇERİK CONTENTS	g	TL/ Ad.
1113 00 6007	Star Lokma / Star Socket E10 - E12 - E14 - E16 - E18 - E20 125 mm Ara Kol / Extension Bar	1075	7 858,50

1113
1/2" Lokmalı Allen Uç
 Hexagonal Bit Socket Wrench

1/2"

 Krom vanadyum, Krom kaplı
 Chrom vanadium, Chrom plated

KOD CODE	mm	L mm	g		TL/Ad.
1113 06 1105	5	60	70	10	137,50
1113 06 1106	6	60	70	10	137,50
1113 06 1107	7	60	75	10	137,50
1113 06 1108	8	60	75	10	137,50
1113 06 1110	10	60	85	10	156,75
1113 06 1112	12	60	100	10	156,75
1113 06 1114	14	60	115	10	156,75
1113 06 4105	5	100	90	10	162,50
1113 06 4106	6	100	90	10	162,50
1113 06 4107	7	100	90	10	162,50
1113 06 4108	8	100	95	10	162,50
1113 06 4110	10	100	105	10	187,75
1113 06 4112	12	100	145	10	187,75
1113 06 4114	14	100	155	10	226,00
1113 06 4117	17	100	200	10	302,00

1113
1/2" Lokmalı Star (Torx®) Uç
 Star (Torx) Bit Socket Wrench

1/2"

 Krom vanadyum, Krom kaplı
 Chrom vanadium, Chrom plated

KOD CODE		L mm	g		TL/Ad.
1113 06 1220	T20	60	70	10	169,25
1113 06 1225	T25	60	70	10	169,25
1113 06 1227	T27	60	70	10	169,25
1113 06 1230	T30	60	70	10	169,25
1113 06 1240	T40	60	70	10	169,25
1113 06 1245	T45	60	70	10	169,25
1113 06 1250	T50	60	75	10	169,25
1113 06 1255	T55	60	80	10	169,25
1113 06 1260	T60	60	100	10	180,25
1113 06 4220	T20	100	78	10	191,50
1113 06 4225	T25	100	79	10	191,50
1113 06 4227	T27	100	80	10	191,50
1113 06 4230	T30	100	80	10	191,50
1113 06 4240	T40	100	80	10	191,50
1113 06 4245	T45	100	82	10	191,50
1113 06 4250	T50	100	82	10	191,50
1113 06 4255	T55	100	100	10	191,50
1113 06 4260	T60	100	134	10	198,50

1113 00 1107
1/2" Lokmalı Allen Uç Takımı (60 mm, 7 Parça)
 Hexagonal Bits Socket Wrench Set (60 mm, 7 Pcs)

1/2"

KOD CODE	İÇERİK CONTENTS	g		TL/Ad.
1113 00 1107	Allen Uçlar 60mm Hex Bit Socket 5-6-7-8-10-12-14	1040	7	1.020,25

1113 00 6009
1/2" Lokmalı Torx® Uç Takımı (60 mm, 9 parça)
 Torx® Bits Socket Wrench Set (60 mm, 9 Pcs)

1/2"

KOD CODE	İÇERİK CONTENTS	g		TL/Ad.
1113 00 6009	Torx® Uçlar 60mm Star Socket T20 - T25 - T27 - T30 - T40 - T45 T50 - T55 - T60	1125	9	1.534,25

1113 00 6017
1/2" Lokmalı Allen Uç ve Star (Torx)® Uç Takımı (17 Parça)
 Hex Bit Sockets - Torx Bit Sockets Set (17 Pcs)

1/2"

KOD CODE	İÇERİK CONTENTS	g		TL/Ad.
1113	T Kol (1/2") Sliding T Handle			
1113	5 - 6 - 7 - 8 - 10 - 12 - 14 Lokmalı Allen Uç 60mm Hex Bit Socket			
1113	T20 - T25 - T27 T30 - T40 T45 - T50 - T55 - T60 Lokmalı Star (Torx) Uç 60mm Torx Bit Socket		17	3.047,50

1114
1/2" Oniki Köşe Lokmalı Bits Uç Yivli (XZN)
 Hex Bit Socket 12 Points (XZN)

1/2"

 Krom vanadyum, Krom kaplı
 Chrom vanadium, Chrom plated

KOD CODE		L mm	g		TL/Ad.
1114 06 4005	M5	60	60	10	124,50
1114 06 4006	M6	60	62	10	124,50
1114 06 4008	M8	60	62	10	124,50
1114 06 4010	M10	60	78	10	124,50
1114 06 4012	M12	60	84	10	147,75
1114 06 4106	M6	80	69	10	157,25
1114 06 4108	M8	80	70	10	157,25
1114 06 4110	M10	80	84	10	173,25
1114 06 4112	M12	80	103	10	179,00
1114 06 4114	M14	80	133	10	191,50
1114 06 4208	M8	140	96	10	176,25
1114 06 4210	M10	140	125	10	216,00
1114 06 4212	M12	140	161	10	243,25
1114 06 4214	M14	140	210	10	273,25
1114 06 4216	M16	140	281	10	396,00

Havalı aletler ile kullanmayınız / Do not use with power-tools

1114
1/2" Lokmalı Ribe Bits Uç
 Socket Wrench 6 Points

1/2"

 Krom vanadyum, Krom kaplı
 Chrom vanadium, Chrom plated

KOD CODE		L mm	g		TL/Ad.
1114 06 5004	4	100	75	10	171,00
1114 06 5005	5	100	76	10	171,00
1114 06 5006	6	100	76	10	171,00
1114 06 5007	7	100	77	10	171,00
1114 06 5008	8	100	78	10	171,00
1114 06 5009	9	100	85	10	172,75
1114 06 5010	10	100	96	10	172,75
1114 06 5011	10.5	100	96	10	176,75
1114 06 5012	12	100	121	10	220,00
1114 06 5013	13	100	148	10	241,25
1114 06 5014	14	100	150	10	241,25
1114 06 5016	16	100	198	10	326,50

1513 06 0032
1/2" Cırcır Kolu (32 Diş)
 Ratchet Handle (32 Teeth)

 TS ISO 3315
 DIN3122

1/2"

 Krom vanadyum, Krom kaplı
 Chrom vanadium, Chrom plated

KOD CODE	L mm	g		TL/Ad.
1513 06 0032	250	580	5	891,00

13000 005277
1000V 1/2" Cırcır Kolu (36 Diş)
 Ratchet Handle 1000V (36 Teeth)

 ⚡ 1000 V
 IEC 60900

1/2"

KOD CODE	L mm	g		TL/Ad.
13000 005277	275	540	1	4.341,75

1513
1/2" Ara Kol
 Extension Bar

 TS ISO 3316
 TS ISO 1174-1
 DIN 3123

1/2"

 Krom vanadyum, Krom kaplı
 Chrom vanadium, Chrom plated

KOD CODE	L mm	g		TL/Ad.
1513 06 4075	75	140	5	202,00
1513 06 4125	125	215	5	226,00
1513 06 4250	250	420	5	343,00

1000V 1/2" Ara Kol
 Extension Bar 1000V

 1000 V
 IEC 60900



1/2"

 Krom vanadyum, Krom kaplı
 Chrom vanadium, Chrom plated

KOD CODE	L mm	g		TL/Ad.
13000 005262	75	140	1	1.150,75
13000 005263	125	215	1	1.275,50
13000 005264	250	420	1	1.732,50

1513 06 5250
1/2" T Kol Adaptörü
 Adapter

1/2"

 Krom vanadyum, Krom kaplı
 Chrom vanadium, Chrom plated

KOD CODE	inch	g		TL/Ad.
1513 06 5250	3/8"Fx1/2"M	90	5	210,25

1513 06 2250
1/2" T Kol
 Sliding T Handle

 TS ISO 3315
 DIN 3122



1/2"

 Krom vanadyum, Krom kaplı
 Chrom vanadium, Chrom plated

KOD CODE	L mm	g		TL/Ad.
1513 06 2250	250	355	5	493,00

13000 005541
1/2" 1000V T Kol
 1000V Sliding T - Handle

 1000 V
 IEC 60900

1/2"

 Krom vanadyum, Krom kaplı
 Chrom vanadium, Chrom plated

KOD CODE	L mm	g		TL/Ad.
13000 005541	250	355	5	1.057,75

1513 06 4070
1/2" Mafsal
 Universal Joint

 TS ISO 3316
 DIN 3123

1/2"

 Krom vanadyum, Krom kaplı
 Chrom vanadium, Chrom plated

KOD CODE	L mm	g		TL/Ad.
1513 06 4070	70	140	5	286,50

1513
1/2" Lokma Adaptörü
 Adapter

 TS ISO 3316
 DIN 3123

1/2"

 Krom vanadyum, Krom kaplı
 Chrom vanadium, Chrom plated

KOD CODE	inch	g		TL/Ad.
1513 06 0002	1/2"Fx3/8"M	55	5	105,75
1513 06 0003	1/2"Fx3/4"M	115	5	166,00

1113 06 5010
1/2" Bits Tutucu Lokma
 Bit Holder Scocket

1/2"

 Krom vanadyum, Krom kaplı
 Chrom vanadium, Chrom plated

KOD CODE	inch	g		TL/Ad.
1113 06 5010	1/2" F x 1/4" F	355	5	120,75

1/4" - 1/2" Altı Köşe Lokma Anahtar Takımı (35 Parça)
Socket Wrench Set 6 Point 1/4" - 1/2" (35 Pcs)

1/4"

1/2"

KOD CODE	LOKMALAR Sockets	AVADANLIKLAR Accessories	g		TL/Ad.
1113 00 1038	4 - 5 - 6 7 - 8 - 9 - 10 11 - 12 - 13 Altı Köşe Six Points	1/4" Cırcır kolu Ratchet Handle 1/4" Mafsal Universal Joint 1/4" T Kol Sliding T Handle 1/4" Ara Kol Extension Bar 50 mm 1/4" Ara Kol Extension Bar 100 mm	4000	35	4.811,50
	10 - 11 - 12 13 - 14 - 15 16 - 17 - 18 19 - 21 - 22 24 - 27 - 30 32 Altı Köşe Six Points	1/2" Cırcır Kolu Ratchet Handle 1/2" T Kol Adaptör Sliding T Handle Adapter 1/2" Ara Kol Extension Bar 75 mm 1/2" Ara Kol Extension Bar 250 mm			

1113 00 2017

1/2" Altı Köşe Lokma Anahtar Takımı (17 Parça, mm)
Socket Wrench Set 6 Points (17 pcs, mm)



KOD CODE	LOKMALAR Sockets	AVADANLIKLAR Accessories	g	TL/Ad.
1113 00 2017		1/2" Cırcır Kolu Ratchet Handle	2880	17
		1/2" T Kol Adaptör Sliding T Handle Adapter		
	10 - 11 - 12 13 - 14 - 15 17 - 19 - 22 24 - 27 - 30 32	1/2" Mafsal Universal Joint		
		1/2" Ara Kol Extension Bar 250 mm		

1113 00 2024

1/2" Altı Köşe Lokma Anahtar Takımı (24 Parça, mm)
Socket Wrench Set 6 Points (24 pcs, mm)



KOD CODE	LOKMALAR Sockets	AVADANLIKLAR Accessories	g	TL/Ad.
1113 00 2024		1/2" Cırcır Kolu Ratchet Handle	3650	24
		1/2" Mafsal Universal Joint		
	10 - 11 - 12 13 - 14 - 15 16 - 17 - 18 19 - 21 - 22 23 - 24 - 26 27 - 28 - 30 32	1/2" T Kol Adaptör Sliding T Handle Adapter		
		1/2" Ara Kol Extension Bar 125 mm		
		1/2" Ara Kol Extension Bar 250 mm		

1114 00 6024

1/2" Oniki Köşe Lokma Anahtar Takımı (24 Parça, mm)
Socket Wrench Set 12 Points (24 pcs, mm)



KOD CODE	LOKMALAR Sockets	AVADANLIKLAR Accessories	g	TL/Ad.
1114 00 6024		1/2" Cırcır Kolu Ratchet Handle	4150	24
		1/2" Mafsal Universal Joint		
	10 - 11 - 12 13 - 14 - 15 16 - 17 - 18 19 - 21 - 22 23 - 24 - 26 27 - 28 - 30 32	1/2" T Kol Adaptör Sliding T Handle Adapter		
		1/2" Ara Kol Extension Bar 125 mm		
		1/2" Ara Kol Extension Bar 250 mm		

1413 00 6024

1/2" Oniki Köşe Lokma Anahtar Takımı (24 parça, SAE)
Socket Wrench Set 12 Points (24 pcs, SAE)



KOD CODE	LOKMALAR Sockets	AVADANLIKLAR Accessories	g	TL/Ad.
1413 00 6024		1/2" Cırcır Kolu Ratchet Handle	4150	24
		1/2" Mafsal Universal Joint		
	5/16" - 3/8" 7/16" - 15/32" 1/2" - 9/16" 19/32" - 5/8" 11/16" - 3/4" 25/32" - 13/16" 7/8" - 15/16" 1" - 1 1/16" 1 1/8" - 1 3/16" 1 1/4"	1/2" T Kol Adaptör Sliding T Handle Adapter		
		1/2" Ara Kol Extension Bar 125 mm		
		1/2" Ara Kol Extension Bar 250 mm		

Yeni Lokma Setleri New Socket Wrench Sets



Ürün Kodu:
14000 005131



Ürün Kodu:
14000 005133



Ürün Kodu:
14000 005130



Ürün Kodu:
14000 005132



Ürün Kodu:
14000 005134



Ürün Kodu:
14000 005135

1119

3/4" Altı Köşe Lokma Anahtar (mm)
Socket Wrench 6 Points (mm)

TS ISO 2725 -1
DIN 3124



3/4"

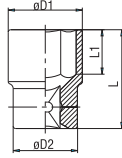

Krom vanadyum, Krom kaplı
Chrom vanadium, Chrom plated

KOD CODE	mm	σ D1 mm	σ D2 mm	L mm	L1 mm	g	TL/ Ad.
1119 06 1022	22	33	36	52	16	225	5 266,75
1119 06 1024	24	35	36	52	16	230	5 266,75
1119 06 1027	27	38	36	52	19	235	5 275,00
1119 06 1030	30	42	38	54	21	300	5 296,50
1119 06 1032	32	44	38	56	23	320	5 308,25
1119 06 1034	34	47	42	58	24	400	5 406,75
1119 06 1036	36	50	42	58	25	440	5 406,75
1119 06 1038	38	52	45	60	27	500	5 406,75
1119 06 1041	41	56	45	64	29	580	1 597,50
1119 06 1046	46	62	48	68	33	730	1 636,50
1119 06 1050	50	68	48	72	34	885	1 764,00
1119 06 1055	55	74	48	76	37	1070	1 972,75
1119 06 1060	60	80	48	78	38	1170	1 1.161,50

1120

3/4" Oniki Köşe Lokma Anahtar (mm)
Socket Wrench 12 Points (mm)

TS ISO 2725 - 1
DIN 3124



3/4"

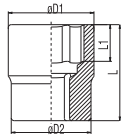

Krom vanadyum, Krom kaplı
Chrom vanadium, Chrom plated

KOD CODE	mm	σ D1 mm	σ D2 mm	L mm	L1 mm	g	TL/ Ad.
1120 06 1022	22	33	36	52	16	220	5 281,50
1120 06 1024	24	35	36	52	17	225	5 281,50
1120 06 1027	27	38	36	52	19	225	5 290,75
1120 06 1030	30	42	38	54	21	285	5 312,75
1120 06 1032	32	44	38	56	23	310	5 327,00
1120 06 1034	34	47	42	57	24	385	5 430,00
1120 06 1036	36	50	42	58	25	435	5 430,00
1120 06 1041	41	56	45	64	29	560	1 635,00
1120 06 1046	46	62	47	68	34	685	1 675,00
1120 06 1050	50	68	48	72	34	840	1 807,75

1419

3/4" Oniki Köşe Lokma Anahtar (SAE)
Socket Wrench 12 Points (SAE)



3/4"

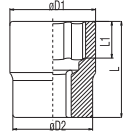

Krom vanadyum, Krom kaplı
Chrom vanadium, Chrom plated

KOD CODE	inch	σ D1 mm	σ D2 mm	L mm	L1 mm	g	TL/ Ad.
1419 06 1022	7/8"	33	36	52	16	220	5 295,50
1419 06 1024	15/16"	35	36	52	16	220	5 295,50
1419 06 1025	1"	35	36	52	17	220	5 296,50
1419 06 1027	1 1/16"	38	36	52	19	225	5 304,50
1419 06 1028	1 1/8"	40	38	52	19	225	5 304,50
1419 06 1032	1 1/4"	44	38	56	23	315	5 341,00
1419 06 1033	1 5/16"	46	38	56	23	355	5 424,75
1419 06 1035	1 3/8"	48	42	58	25	400	5 424,75
1419 06 1036	1 7/16"	50	42	58	25	425	5 445,00
1419 06 1038	1 1/2"	52	45	60	27	475	5 445,00
1419 06 1041	1 5/8"	56	45	64	29	555	1 659,25
1419 06 1044	1 3/4"	60	47	66	31	660	1 695,50
1419 06 1046	1 13/16"	62	47	68	34	685	1 700,00
1419 06 1047	1 7/8"	64	48	70	34	730	1 839,75
1419 06 1050	2"	68	48	72	34	805	1 845,50

1519 06 4510

3/4" Cırcır Kolu (45 Diş)
Ratchet Handle (45 Teeth)

TS ISO 3315
DIN 3122



3/4"

Krom vanadyum, Krom kaplı
Chrom vanadium, Chrom plated

KOD CODE	L mm	g	TL/ Ad.
1519 06 4510	510	2230	5 2.641,75

1519

3/4" Ara Kol
Extension Bar

TS ISO 3316
DIN 3123



3/4"

Krom vanadyum, Krom kaplı
Chrom vanadium, Chrom plated

KOD CODE	L mm	g	TL/ Ad.
1519 06 4200	200	730	5 696,75
1519 06 4400	400	1370	5 1.262,00

1519 06 4500

3/4" T Kol
Sliding T - Handle

TS ISO 3315
DIN 3122



3/4"

Krom vanadyum, Krom kaplı
Chrom vanadium, Chrom plated

KOD CODE	L mm	g		TL/Ad.
1519 06 4500	500	1485	5	1.404,00

1519

3/4" Lokma Adaptörü
Adapter

TS ISO 3316
DIN 3123



3/4"

Krom vanadyum, Krom kaplı
Chrom vanadium, Chrom plated

KOD CODE	inch	g		TL/Ad.
1519 06 0008	3/4"Fx1/2"M	140	5	278,00
1519 06 0001	3/4"Fx1"M	300	5	376,00

1119 00 6114

3/4" Altı Köşe Lokma Anahtar Takımı (14 parça, mm)
Socket Wrench Set 6 Points (14 pcs, mm)



3/4"

KOD CODE	LOKMALAR Sockets	AVADANLIKLAR Accessories	g		TL/Ad.
1119 00 6114		3/4" Cırcır Kolu Ratchet Handle	10180	14	10.229,25
		3/4" T Kol Sliding T Handle			
	22 - 24 - 27 30 - 32 - 34 36 - 41 - 46 50	3/4" Ara Kol Extension Bar 200 mm			
		3/4" Ara Kol Extension Bar 400 mm			

1120 00 6014

3/4" Oniki Köşe Lokma Anahtar Takımı (14 parça, mm)
Socket Wrench Set 12 Points (14 pcs, mm)



3/4"

KOD CODE	LOKMALAR Sockets	AVADANLIKLAR Accessories	g		TL/Ad.
1120 00 6014		3/4" Cırcır Kolu Ratchet Handle	13700	14	10.475,75
		3/4" T Kol Sliding T Handle			
	22 - 24 - 27 30 - 32 - 34 36 - 41 - 46 50	3/4" Ara Kol Extension Bar 200 mm			
		3/4" Ara Kol Extension Bar 400 mm			

1419 00 6114

3/4" Oniki Köşe Lokma Anahtar Takımı (14 parça, SAE)
Socket Wrench Set 12 Points (14 pcs, SAE)



3/4"

KOD CODE	LOKMALAR Sockets	AVADANLIKLAR Accessories	g		TL/Ad.
1419 00 6114		3/4" Cırcır Kolu Ratchet Handle	10180	14	10.889,00
		3/4" T Kol Sliding T Handle			
	15/16" - 11/16" 11/8" - 11/4" 15/16" 13/8" 11/2" - 15/8" 17/8" - 2"	3/4" Ara Kol Extension Bar 200 mm			
		3/4" Ara Kol Extension Bar 400 mm			

1225
1" Oniki Köşe Lokma Anahtar (mm)
 Socket Wrench 12 Points (mm)

 TS ISO 2727-1
 DIN 3124

1"

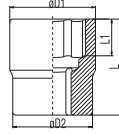
 Krom vanadyum, Krom kaplı
 Chrom vanadium, Chrom plated

KOD CODE	mm	ø D1 mm	ø D2 mm	L mm	L1 mm	g	TL/Ad.
1225 06 0036	36	52	48	65	26	525	1 833,00
1225 06 0041	41	58	50	70	29	665	1 906,75
1225 06 0046	46	65	54	75	32	900	1 1.099,50
1225 06 0050	50	70	57	75	34	1040	1 1.302,25
1225 06 0055	55	76	57	83	42	1250	1 1.667,50
1225 06 0060	60	82	60	87	46	1505	1 2.167,50

1525 06 0005
1" Lokma Adaptörü
 Adapter

 TS ISO 3316
 DIN 3123

1"

 Krom vanadyum, Krom kaplı
 Chrom vanadium, Chrom plated

KOD CODE	inch	g	TL/Ad.
1525 06 0005	1"Fx3/4"M	330	5 536,00

1800
Kovan Anahtar İki Ağız (mm)
 Double Ended Tubular Socket Wrench (mm)

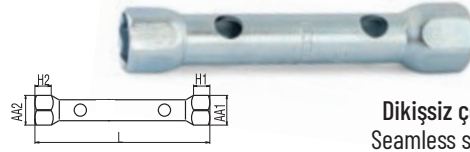
 TS ISO 3793
 DIN 896

 Dikişsiz çelik boru, Çinko kaplı
 Seamless steel tube, Zinc plated

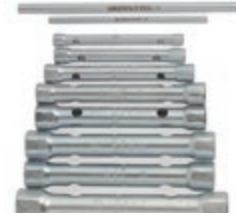
KOD CODE	mm	L mm	AA1 mm	AA2 mm	H1 mm	H2 mm	g	TL/Ad.
1800 07 0607	6x7	105	8.6	9.6	7	8	25	5 124,25
1800 07 0809	8x9	105	11.2	12.2	9	10	35	5 136,00
1800 07 1011	10x11	120	13.6	14.6	11	11.5	55	5 186,00
1800 07 1213	12x13	135	16	17	12	12.5	80	5 197,50
1800 07 1415	14x15	135	18.5	19.5	13	13.5	110	5 216,50
1800 07 1617	16x17	150	21	22	14	14.5	150	5 232,25
1800 07 1819	18x19	150	23	24	15	15.5	170	5 241,00
1800 07 2022	20x22	165	25.4	27.4	16	18	220	5 265,25
1800 07 2224	22x24	180	27.4	29.4	18	20	330	5 298,00
1800 07 2427	24x27	180	30.4	33.4	20	23	400	5 384,75

1800 00 2108
Kovan Anahtar Takımı İki Ağız (mil dahil, mm)
 Double Ended Tubular Socket Wrench Set
 with Tommy Bars (mm)

KOD CODE	mm	g	TL/Ad.
1800 00 2108	6x7 - 8x9 - 10x11 - 12x13 - 14x15 16x17 - 18x19 - 20x22 Mil/Handle Bars 5x125-8x180 mm	920	10 1.722,50

1841 07 0021
Kovan Anahtar Bir Ağız (mil dahil)
 Single Ended Tubular Socket Wrench with Tommy Bar

 Dikişsiz çelik boru, Çinko kaplı
 Seamless steel tube, Zinc plated

KOD CODE	mm		L mm	øD mm	Mil Handle bar mm	g	TL/Ad.
	mm	inch					
1841 07 0021	21	13/16"	120	20	10x120	215	5 206,25

1850

Kovan Anahtar Mili
Tommy Bar

TS ISO 3793
DIN 900



KOD CODE	σDxL mm	g	□	TL/Ad.
1850 07 5125	5x125	20	10	49,00
1850 07 8180	8x180	70	10	74,75
1850 07 1120	10x120	75	10	85,00
1850 07 1200	10x200	120	10	95,75

1870

Ağır Tip Bijon Anahtarı İki Ağzı Uzun
Double Ended Rim Wrench (long)

TSEK

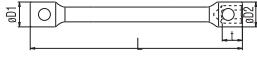

Yüksek alaşımlı çelik, Nikel kaplı
Special steel, Nickel plated

KOD CODE	mm	L mm	t mm	σD1 mm	σD2 mm	g	□	TL/Ad.
1870 09 2427	24x27	400	34.5	36	40	1135	10	526,00
1870 09 2730	27x30	400	34.5	40	44	1380	10	604,00
1870 09 2732	27x32	400	34.5	40	46	1380	10	604,00
1870 09 3032	30x32	400	34.5	44	46	1380	10	625,00
1870 09 3233	32x33	400	34.5	46	47	1450	10	693,50

1874

Ağır Tip Bijon Anahtarı İki Ağzı Kısa
Double Ended Rim Wrench (short)

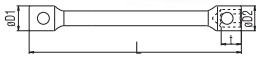

Yüksek alaşımlı çelik, Nikel kaplı
Special steel, Nickel plated

KOD CODE	mm	L mm	t mm	σD1 mm	σD2 mm	g	□	TL/Ad.
1874 09 2224	22x24	170	34.5	34	36	720	10	333,50
1874 09 2427	24x27	200	34.5	36	40	800	10	425,75

1850 09 1630

Bijon Anahtar Mili
Tommy Bar

TS ISO 3793
DIN 900

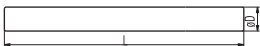

KOD CODE	σDxL mm	g	□	TL/Ad.
1850 09 1630	18x630	1260	1	306,25

1975 09 1719

Bijon Anahtarı İstavroz Tipi
Cross Rim Wrench

TSE

TS ISO 6788

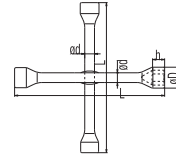

Yüksek alaşımlı çelik, Krom kaplı
Special steel, Chrom plated

KOD CODE	mm	inch	σD mm	h mm	L mm	σd mm	g	□	TL/Ad.
	17	11/16"	28	17					
1975 09 1719	19	3/4"	30	18.5	420	16	1422	10	650,25
	21	13/16"	32	19.5					
	22	7/8"	34	20.5					

1975 09 1322

1/2" Adaptörlü Bijon Anahtarı İstavroz Tipi
Cross Rim Wrench (with 1/2" adapter)

TSE

TS ISO 6788

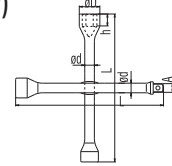

Yüksek alaşımlı çelik, Krom kaplı
Special steel, Chrom plated

KOD CODE	mm	inch	σD mm	h mm	L mm	A mm	σd mm	g	□	TL/Ad.
	17	11/16"	28	17						
1975 09 1322	19	3/4"	30	18.5	420	12.65	16	1375	10	653,50
	22	7/8"	34	20.5						
		1/2"								

1940

Bijon Anahtarı Pipo Tipi (Tornavida Ağzılı)
Offset Socket Wrench with Screwdriver

TSEK

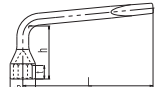

Yüksek alaşımlı çelik, Krom kaplı
Special steel, Chrom plated

KOD CODE	mm	inch	L mm	σD mm	h mm	g	□	TL/Ad.
1940 09 0017	17	11/16"	285	28	65	485	10	326,75
1940 09 0019	19	3/4"	285	30	65	470	10	345,25
1940 09 0021	21	13/16"	320	32	85	575	10	373,00

1840 08 0500

1/2" Mafsallı T Kol
Swivel Handle With Sliding T 1/2"

1/2"



Özel alaşım çelik, Krom kaplı
Special steel, Chrom plated

KOD CODE	mm	L mm	g	□	TL/Ad.
1840 08 0500	1/2"	600	740	10	1.334,25

1610

3/8" Tork Anahtarı
Torque Wrench

TS EN ISO 6789-1
TS EN ISO 6789-2



3/8"

KOD CODE	ÖLÇÜ SIZE	L mm	g	TL/Ad.
1610 06 0100	2.5 - 11 Nm - 0.3 - 1.2 Kg	310	515	1 7.383,50
1610 06 0300	7 - 33 Nm - 0.5 - 3.4 Kg	425	640	1 7.633,75

1613

1/2" Tork Anahtarı
Torque Wrench

TS EN ISO 6789-1
TS EN ISO 6789-2



1/2"

KOD CODE	ÖLÇÜ SIZE	L mm	g	TL/Ad.
1613 06 1200	25 - 135 Nm - 3 - 14 Kg	550	1430	1 7.883,25
1613 06 2000	50 - 225 Nm - 5 - 23 Kg	600	2165	1 8.136,75
1613 06 3000	70 - 330 Nm - 7 - 35 Kg	830	2870	1 9.901,00

1619 06 2080

3/4" Tork Anahtarı
Torque Wrench

TS EN ISO 6789-1
TS EN ISO 6789-2



3/4"



İZELTAS USTA İŞİ
SOHBETLER

KOD CODE	ÖLÇÜ SIZE	L mm	g	TL/Ad.
1619 06 2080	200 - 800 Nm - 22 - 82 kg	1030	8860	1 30.510,00

1607 06 0420

1/4" Cırcırlı Tork Anahtar
Torque Wrench With Reversible Ratchet-Head

TS EN ISO 6789-1
TS EN ISO 6789-2



İZELTAS YOUTUBE

1/4"

KOD CODE	ÖLÇÜ SIZE	L mm	g	TL/Ad.
1607 06 0420	4 - 20 Nm	320	640	1 5.844,75

1610 06 2010

3/8" Cırcırlı Tork Anahtar
Torque Wrench With Reversible Ratchet-Head

TS EN ISO 6789-1
TS EN ISO 6789-2



3/8"

KOD CODE	ÖLÇÜ SIZE	L mm	g	TL/Ad.
1610 06 2010	20 - 100 Nm	435	1300	1 6.598,75

1613

1/2" Cırcırlı Tork Anahtar
Torque Wrench With Reversible Ratchet-Head

TS EN ISO 6789-1
TS EN ISO 6789-2



1/2"

KOD CODE	ÖLÇÜ SIZE	L mm	g	TL/Ad.
1613 06 4020	40 - 200 Nm	520	1590	1 7.729,50
1613 06 6034	60 - 340 Nm	610	1810	1 8.103,75

1619 06 1060

3/4" Cırcırlı Tork Anahtar
Torque Wrench With Reversible Ratchet-Head

TS EN ISO 6789-1
TS EN ISO 6789-2



3/4"

KOD CODE	ÖLÇÜ SIZE	L mm	g	TL/Ad.
1619 06 1060	100 - 600 Nm	1050	5600	1 21.431,75

**Lokmayı salmayan bilya tasarımı
(kare adaptörlü bilyalı tasarım)**
Square adaptor with ball design to lock sockets

Değiştirilebilir iç mekanizma
Inter-changeable inner mechanism

Yüksek dayanım için güçlü 32 diş
32 teeth for high endurance

Çift yönlü kullanım sağlayan mandal tasarımı
Bi-directional latch design

Yüksek mukavemetli alaşımlı sıcak dövme çeliği
High strength alloyed cold work tool steel

Nikel üzerine krom kaplama ile korozyon direncinde üst seviye koruma
High corrosion resistance with chrome over nickel plating

Dayanımı yüksek sert plastikten ve konforlu tutuş sağlayan yumuşak elastomer malzemeden imal edilmiş çift komponentli ergonomik sap
Two component ergonomic handle with high strength and soft grip plastic



İZELTAS USTA İŞİ
SOHBETLER



İZELTAS YOUTUBE

HAVALI LOKMA GRUBU

IMPACT SOCKET

Havali Lokma Anahtarlar
Impact Socket Wrenches



3/8" Altı Köşe Havalı Lokma Anahtar (mm)
Impact Socket Wrench 6 Points (mm)

TS ISO 2725-2

3/8" Altı Köşe Havalı Derin Lokma Anahtar (mm)
Impact Socket Wrench 6 Points Long Type (mm)

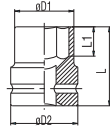

3/8"

Krom molibden, Fosfat kaplamalı
Chrom molybdenum, Phosphate finish

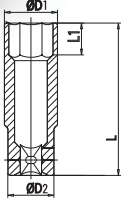

3/8"

Krom molibden, Fosfat kaplamalı
Chrom molybdenum, Phosphate finish

KOD CODE	mm	σ D1 mm	σ D2 mm	L mm	L1 mm	g	TL/ Ad.	
14000 004583	6	10.6	19	32	5	33	10	120,00
14000 004584	7	11.8	19	32	5	33	10	120,00
14000 004585	8	13.2	19	32	6	35	10	120,00
14000 004586	9	14.5	19	32	6	35	10	120,00
14000 004587	10	15.5	19	32	7	40	10	120,00
14000 004588	11	17	19	32	7	40	10	120,00
14000 004589	12	18.2	19	32	8	40	10	120,00
14000 004590	13	19.4	22	32	9	55	10	125,00
14000 004591	14	20.7	22	32	9	55	10	125,00
14000 004592	15	22	22	32	10	55	10	142,25
14000 004593	16	23.8	22	32	10	60	10	142,25
14000 004594	17	24.8	22	32	11	60	10	142,25
14000 004595	18	25.8	22	32	11	60	10	142,25
14000 004596	19	27.6	22	32	13	65	10	160,00
14000 004597	20	28.3	22	32	13	70	10	165,00
14000 004598	21	29.5	22	32	13	75	10	169,00
14000 004599	22	30.8	22	32	13	85	10	191,25
14000 004600	23	32	22	32	13	90	10	191,25

KOD CODE	mm	σ D1 mm	σ D2 mm	L mm	L1 mm	g	TL/ Ad.	
14000 004601	6	10.6	19	65	10	50	10	231,00
14000 004602	7	11.8	19	65	10	55	10	231,00
14000 004603	8	13.2	19	65	12	70	10	231,00
14000 004604	9	14.5	19	65	12	65	10	231,00
14000 004605	10	15.5	19	65	12	80	10	231,00
114000 004606	11	17	19	65	13	75	10	231,00
14000 004607	12	18.2	19	65	14	90	10	231,00
14000 004608	13	19.4	22	65	14	100	10	240,50
14000 004609	14	20.7	22	65	14	110	10	240,50
14000 004610	15	22	22	65	16	110	10	246,25
14000 004611	16	23.8	22	65	16	125	10	246,25
14000 004612	17	24.8	22	65	17	145	10	276,00
14000 004613	18	25.8	22	65	18	135	10	281,00
14000 004614	19	27.6	22	65	20	170	10	281,00
14000 004615	20	28.3	22	65	20	155	10	292,00
14000 004616	21	29.5	22	65	22	160	10	293,00
14000 004617	22	30.8	22	65	22	180	10	293,00
14000 004618	23	32	22	65	24	180	10	308,00



3/8" Havalı Lokma Ara Kol Impact Socket Extension Bar

TS ISO 1174-2

**YENİ
NEW**



3/8"

Krom molibden, Fosfat kaplamalı
Chrom molybdenum, Phosphate finish

KOD CODE	L mm	g	□	TL/Ad.
14000 004619	75	100	10	259,50
14000 004620	125	150	10	344,25

14000 004621

3/8" Havalı Lokma Adaptör Impact Socket Adapter

**YENİ
NEW**



3/8"

Krom molibden, Fosfat kaplamalı
Chrom molybdenum, Phosphate finish

KOD CODE	□ inch	g	□	TL/Ad.
14000 004621	3/8"Fx1/2"M	55	10	186,50

14000 004622

3/8" Havalı Lokma Mafsıl Impact Socket Universal Joint

**YENİ
NEW**



3/8"

Krom molibden, Fosfat kaplamalı
Chrom molybdenum, Phosphate finish

KOD CODE	□ inch	g	□	TL/Ad.
14000 004622	3/8"	90	10	561,50

1113 00 9003

1/2" Alaşımli Jant Lokma Takımı (mm) Impact Socket Wrench 6 Points (mm)



1/2"

KOD CODE	LOKMA LAR Sockets	g	□	TL/Ad.
1113 00 9003	17 - 19 - 21	800	3	1.403,00

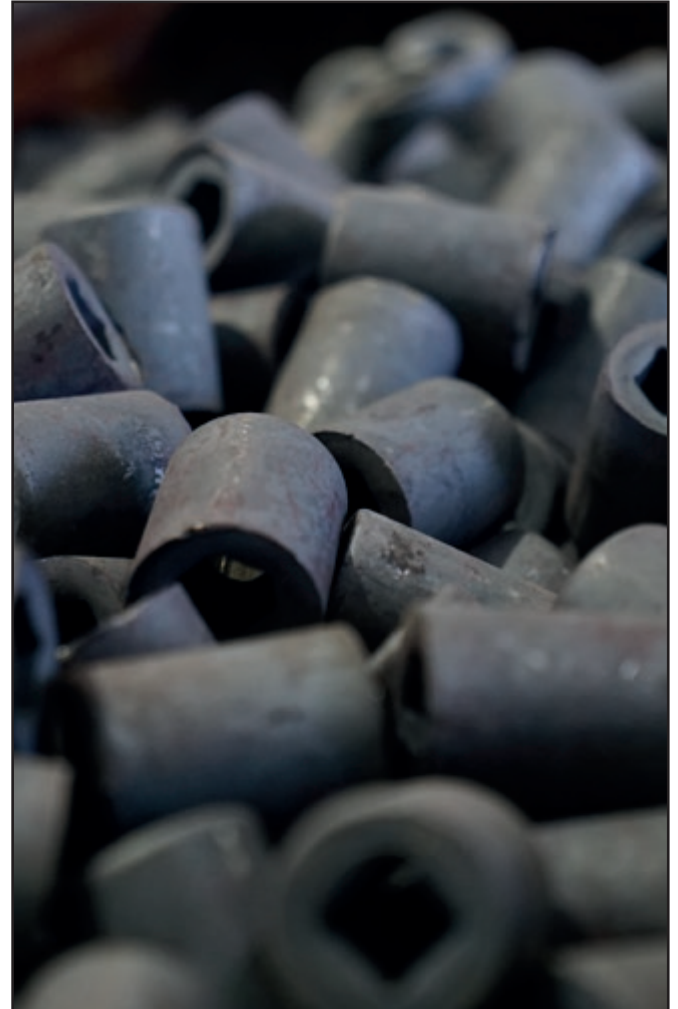

1113

1/2" Altı Köşe Havalı Lokma Anahtar (mm)
Impact Socket Wrench 6 Points (mm)

TS ISO 2725-2



İZELTAS YOUTUBE

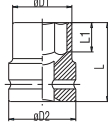

1/2"

Krom molibden, Fosfat kaplamalı
Chrom molybdenum, Phosphate finish

KOD CODE	mm	σ D1 mm	σ D2 mm	L mm	L1 mm	g	TL/ Ad.
1113 06 7008	8	15	25	38	7	65	10 121,25
1113 06 7009	9	16.5	25	38	7	70	10 121,25
1113 06 7010	10	17.6	25	38	8	70	10 122,50
1113 06 7011	11	18.8	25	38	8	70	10 122,50
1113 06 7012	12	20	25	38	9	75	10 122,50
1113 06 7013	13	21.2	25	38	10	75	10 131,25
1113 06 7014	14	22.5	25	38	10	80	10 131,25
1113 06 7015	15	23.8	30	38	11	115	10 151,00
1113 06 7016	16	25	30	38	11	120	10 158,00
1113 06 7017	17	26.2	30	38	12	120	10 158,25
1113 06 7018	18	27.5	30	38	13	125	10 159,00
1113 06 7019	19	28.8	30	38	13	115	10 161,75
1113 06 7020	20	29.5	30	38	13	115	10 169,25
1113 06 7021	21	30	30	40	14	120	10 170,50
1113 06 7022	22	32.4	30	40	14	130	10 195,00
1113 06 7023	23	33.2	30	40	15	145	10 203,75
1113 06 7024	24	34.4	30	42	15	140	10 201,75
1113 06 7025	25	36	30	42	15	155	10 238,50
1113 06 7026	26	37	30	42	15	175	10 240,50
1113 06 7027	27	37.8	30	44	16	175	10 256,25
1113 06 7028	28	39.8	30	44	16	205	10 275,00
1113 06 7029	29	39.8	30	44	17	200	10 278,75
1113 06 7030	30	41.8	30	44	17	205	10 300,00
1113 06 7032	32	46	30	44	19	240	10 327,00

1108

1/2" Altı Köşe Havalı Derin Lokma Anahtar (mm) TS ISO 2725-2
Impact Socket Wrench 6 Point, Long Type (mm)

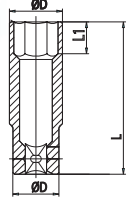

1/2"

Krom molibden, Fosfat kaplamalı
Chrom molybdenum, Phosphate finish

KOD CODE	mm	σ D1 mm	σ D2 mm	L mm	L1 mm	g	TL/ Ad.
1108 06 7008	8	15	24.8	78	12	125	10 232,00
1108 06 7009	9	16.3	24.8	78	12	135	10 232,00
1108 06 7010	10	17.6	24.8	80	12	150	10 233,00
1108 06 7011	11	18.8	24.8	80	13	155	10 233,00
1108 06 7012	12	20	24.8	80	14	165	10 233,00
1108 06 7013	13	21.2	24.8	80	14	170	10 252,75
1108 06 7014	14	22.5	24.8	80	14	170	10 252,75
1108 06 7015	15	23.8	29.8	80	16	225	10 282,00
1108 06 7016	16	25	29.8	80	16	235	10 282,00
1108 06 7017	17	26.2	29.8	80	16	240	10 282,00
1108 06 7018	18	27.5	29.8	80	17	245	10 282,00
1108 06 7019	19	28.8	29.8	80	18	255	10 282,00
1108 06 7020	20	29	29.8	80	20	245	10 293,00
1108 06 7021	21	29.8	29.8	80	20	245	10 294,50
1108 06 7022	22	32.4	30	80	22	280	10 294,50
1108 06 7023	23	33.2	30	80	24	315	10 309,00
1108 06 7024	24	34.4	30	80	24	295	10 310,75
1108 06 7025	25	36	30	80	24	325	10 365,50
1108 06 7026	26	37	30	80	27	365	10 369,25
1108 06 7027	27	37.8	30	80	27	365	10 411,25
1108 06 7028	28	39.8	30	80	27	425	10 413,50
1108 06 7029	29	39.8	30	80	27	405	10 413,50
1108 06 7030	30	41.8	30	80	30	420	10 461,00
1108 06 7032	32	46	30	80	32	505	10 491,25

1/2" Havalı Star (Torx®) Lokma Anahtar
Impact Socket Star (Torx®) Wrench



Krom molibden, Fosfat kaplamalı
Chrom molybdenum, Phosphate finish

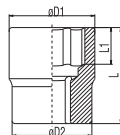

1/2"

KOD CODE	mm	σ D1 mm	σ D2 mm	L mm	L1 mm	g	TL/ Ad.
14000 004539	E10	14	25	38	7.5	70	10 240,50
14000 005160	E12	15.9	25	38	9	70	10 240,50
14000 004540	E14	17.7	25	38	10	70	10 240,50
14000 004541	E16	20	25	38	11	75	10 240,50
14000 004542	E18	22	25	38	12.5	80	10 269,25
14000 004543	E20	24.5	30	38	14	120	10 288,50
14000 004544	E22	26	30	38	15	120	10 313,50
14000 004545	E24	28	30	38	16	120	10 327,00

1/2" Havalı Allen Uç Lokma Anahtar Impact Socket Hexagonal Bits Socket Wrench



1/2"

Krom molibden, Fosfat kaplamalı
Chrom molybdenum, Phosphate finish

KOD CODE	mm	L mm	g		TL/Ad.
14000 004546	H4	80	70	10	307,75
14000 004547	H5	80	75	10	307,75
14000 004548	H6	80	75	10	307,75
14000 004549	H8	80	85	10	336,50
14000 004550	H10	80	100	10	336,50
14000 004551	H12	80	120	10	336,50
14000 004552	H14	80	140	10	336,50
14000 004553	H17	80	220	10	355,75
14000 004554	H19	80	245	10	423,00

1/2" Havalı Torx Uç Lokma Anahtar Impact Socket Star (Torx®) Bits Socket Wrench



1/2"

Krom molibden, Fosfat kaplamalı
Chrom molybdenum, Phosphate finish

KOD CODE		L mm	g		TL/Ad.
14000 004573	T20	100	70	10	355,75
14000 004574	T25	100	70	10	355,75
14000 004575	T27	100	75	10	355,75
14000 004576	T30	100	75	10	355,75
14000 004577	T40	100	80	10	355,75
14000 004578	T45	100	90	10	365,50
14000 004579	T50	100	100	10	375,00
14000 004580	T55	100	120	10	375,00
14000 004581	T60	100	140	10	375,00
14000 004582	T80	100	180	10	423,00

1513 06 7125

1/2" Havalı Lokma Ara Kol Impact Socket Extension Bar

TS ISO 1174-2



1/2"

Krom molibden, Fosfat kaplamalı
Chrom molybdenum, Phosphate finish

KOD CODE	L mm	g		TL/Ad.
1513 06 7125	125	275	5	464,50

1513

1/2" Havalı Lokma Adaptörü Impact Socket Adapter



1/2"

Krom molibden, Fosfat kaplamalı
Chrom molybdenum, Phosphate finish

KOD CODE	inch	g		TL/Ad.
1513 06 7002	1/2"Fx3/8"M	95	5	307,25
1513 06 7003	1/2"Fx3/4"M	175	5	350,75

1513 06 7075

1/2" Havalı Lokma Mafsalsal Impact Socket Universal Joint



1/2"

Krom molibden, Fosfat kaplamalı
Chrom molybdenum, Phosphate finish

KOD CODE	L mm	g		TL/Ad.
1513 06 7075	75	220	5	589,50

3/4" Altı Köşe Havalı Lokma Anahtar (mm)
Impact Socket Wrench 6 Points (mm)

TS ISO 2725-2

3/4"
Krom molibden, Fosfat kaplamalı
Chrom molybdenum, Phosphate finish

KOD CODE	mm	σ D1 mm	σ D2 mm	L mm	L1 mm	g	TL/Ad.
1119 06 7017	17	29	44	50	10	310	5 461,50
1119 06 7018	18	30	44	50	10	315	5 461,50
1119 06 7019	19	32	44	50	10	325	5 461,50
1119 06 7020	20	33	44	50	10	335	5 461,50
1119 06 7021	21	35	44	50	13	335	5 461,50
1119 06 7022	22	36	44	50	13	340	5 461,50
1119 06 7023	23	37	44	50	15	340	5 461,50
1119 06 7024	24	38	44	50	15	345	5 461,50
1119 06 7025	25	41	44	53	15	365	5 461,50
1119 06 7026	26	40	44	53	15	365	5 461,50
1119 06 7027	27	42	44	53	18	380	5 461,50
1119 06 7028	28	44	44	53	18	390	5 461,50
1119 06 7029	29	45	44	53	18	400	5 461,50
1119 06 7030	30	46	44	53	20	350	1 461,50
1119 06 7032	32	48	44	57	20	455	1 461,50
1119 06 7033	33	50	44	57	20	480	1 519,25
1119 06 7034	34	51	44	57	22	490	1 594,00
1119 06 7035	35	53	44	57	22	500	1 528,75
1119 06 7036	36	53	44	57	22	510	1 594,00
1119 06 7038	38	56	44	57	22	555	1 577,00
1119 06 7041	41	59	44	58	24	585	1 916,50
1119 06 7044	44	64	44	62	24	706	1 970,00
1119 06 7046	46	66	44	62	24	730	1 974,25
1119 06 7050	50	71	44	65	26	870	1 1.115,50
1119 06 7055	55	77	54	70	30	1200	1 1.269,25
1119 06 7060	60	84	54	70	32	1425	1 1.557,75

3/4" Altı Köşe Havalı Derin Lokma Anahtar (mm)
Impact Socket Wrench 6 Points, Long Type (mm)

TS ISO 2725-2

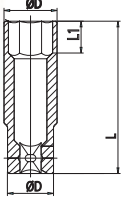
3/4"
Krom molibden, Fosfat kaplamalı
Chrom molybdenum, Phosphate finish

KOD CODE	mm	σ D1 mm	σ D2 mm	L mm	L1 mm	g	TL/Ad.
14000 004504	17	29	44	90	15	480	5 702,00
14000 004505	18	30	44	90	15	500	5 702,00
14000 004506	19	32	44	90	16	545	5 702,00
14000 004507	20	32	44	90	17	545	5 702,00
14000 004508	21	35	44	90	18	565	5 702,00
14000 004509	22	36	44	90	18	580	5 702,00
14000 004510	23	37	44	90	23	600	5 702,00
14000 004511	24	38	44	90	23	600	5 702,00
14000 004512	25	40	44	90	25	630	5 702,00
14000 004513	26	40	44	90	25	600	5 702,00
14000 004514	27	42	44	90	27	625	5 702,00
14000 004515	28	44	44	90	27	665	5 721,25
14000 004516	29	45	44	90	27	665	5 730,75
14000 004517	30	46	44	90	27	695	1 730,75
14000 004518	32	48	44	90	30	730	1 730,75
14000 004519	33	50	44	90	30	790	1 788,50
14000 004520	34	51	44	90	32	795	1 817,25
14000 004521	35	52	44	90	32	810	1 884,50
14000 004522	36	53	44	90	32	820	1 884,50
14000 004523	38	56	44	90	34	880	1 980,75
14000 004524	41	59	44	90	34	935	1 1.173,00
14000 004525	46	66	44	95	38	1240	1 1.288,50
14000 004526	50	71	44	95	40	1315	1 1.605,75
14000 004527	55	77	54	100	45	1800	1 1.921,25

3/4" Havalı Allen Uç Lokma Anahtar (mm)
Impact Socket Hexagonal Bits Socket Wrench
Krom molibden, Fosfat kaplamalı
Chrom molybdenum, Phosphate finish

3/4"

KOD CODE	mm	L mm	g	TL/Ad.
14000 004528	H14	87	310	5 1.125,00
14000 004529	H17	87	340	5 1.125,00
14000 004530	H19	87	365	5 1.125,00
14000 004531	H21	87	510	5 1.125,00
14000 004532	H22	87	525	5 1.125,00
14000 004533	H24	87	545	5 1.211,50
14000 004534	H27	87	600	5 1.211,50
14000 004535	H30	87	710	1 1.211,50
14000 004536	H32	87	750	1 1.336,50
14000 004537	H36	87	830	10 1.384,50

1519

3/4" Havalı Lokma Ara Kol
Impact Socket Extension Bar

TS ISO 1174-2



1519 06 7108

3/4" Havalı Lokma Mafsal
Impact Socket Universal Joint



3/4"

Krom molibden, Fosfat kaplamalı
Chrom molybdenum, Phosphate finish

KOD CODE	L mm	g	Ad.	TL/ Ad.
1519 06 7175	175	865	5	1.012,50
1519 06 7250	250	1155	5	1.447,75
1519 06 7330	330	1425	5	2.197,25

3/4"

Krom molibden, Fosfat kaplamalı
Chrom molybdenum, Phosphate finish

KOD CODE	L mm	g	Ad.	TL/ Ad.
1519 06 7108	108	735	5	1.686,25

1519

3/4" Havalı Lokma Adaptörü
Impact Socket Adapter



3/4"

Krom molibden, Fosfat kaplamalı
Chrom molybdenum, Phosphate finish

KOD CODE	inch	g	Ad.	TL/ Ad.
1519 06 7011	3/4"Fx1/2"M	315	5	584,50
1519 06 7012	3/4"Fx1"M	445	5	759,50

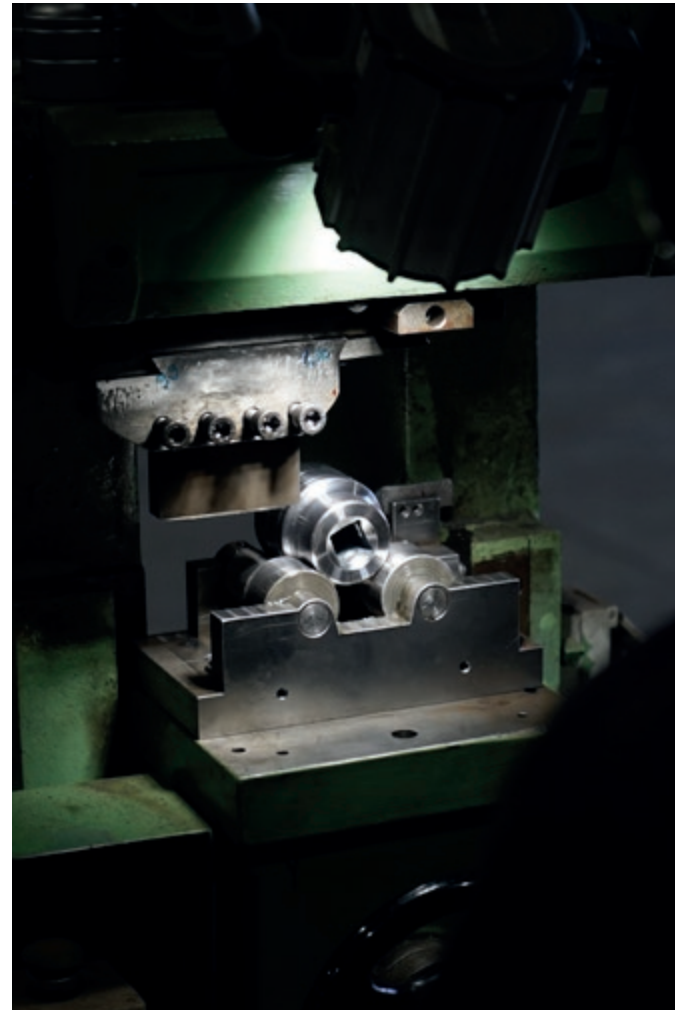

1" Altı Köşe Havalı Lokma Anahtar (mm)
Impact Socket Wrench 6 Points (mm)

TS ISO 2725-2

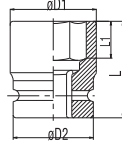
1"
Krom molibden, Fosfat kaplamalı
Chrom molybdenum, Phosphate finish

KOD CODE	Ø mm	σ D1 mm	σ D2 mm	L mm	L1 mm	g	TL/Ad.
1125 06 7021	21	37	54	58	15	540	1 682,75
1125 06 7022	22	38	54	58	15	550	1 682,75
1125 06 7023	23	39	54	58	17	545	1 682,75
1125 06 7024	24	41	54	58	17	560	1 682,75
1125 06 7025	25	42	54	58	17	560	1 682,75
1125 06 7026	26	43	54	58	19	565	1 682,75
1125 06 7027	27	44	54	58	19	565	1 682,75
1125 06 7028	28	45	54	58	19	570	1 682,75
1125 06 7029	29	47	54	58	19	590	1 682,75
1125 06 7030	30	48	54	60	20	590	1 753,25
1125 06 7032	32	51	54	62	20	645	1 762,25
1125 06 7033	33	52	54	62	20	660	1 762,25
1125 06 7034	34	53	54	62	20	665	1 766,00
1125 06 7035	35	54	54	62	20	665	1 768,00
1125 06 7036	36	56	54	65	20	720	1 769,50
1125 06 7038	38	58	54	65	22	735	1 801,50
1125 06 7041	41	61	54	70	22	825	1 976,25
1125 06 7046	46	68	54	75	26	1035	1 1.077,00
1125 06 7048	48	70	54	75	26	1060	1 1.148,50
1125 06 7050	50	73	54	75	26	1170	1 1.148,50
1125 06 7055	55	79	54	83	32	1435	1 1.522,75
1125 06 7060	60	86	54	87	32	1695	1 1.903,50
1125 06 7065	65	92	54	90	34	1750	1 2.115,50
1125 06 7070	70	97	54	93	34	2035	1 2.788,50
1125 06 7075	75	104	86	95	36	3120	1 3.750,00
1125 06 7080	80	110	86	95	43	3390	1 4.327,00
1125 06 7085	85	115	86	95	43	3530	1 5.769,25
1125 06 7090	90	122	86	100	43	4005	1 7.019,25

1" Altı Köşe Havalı Derin Lokma Anahtar (mm)
Impact Socket Wrench 6 Points, Long Type (mm)

TS ISO 2725-2

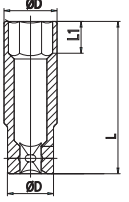
1"
Krom molibden, Fosfat kaplamalı
Chrom molybdenum, Phosphate finish

KOD CODE	Ø mm	σ D1 mm	σ D2 mm	L mm	L1 mm	g	TL/Ad.
14000 004462	21	38	54	90	25	810	1 942,25
14000 004463	22	39	54	90	25	840	1 942,25
14000 004464	23	40	54	90	25	850	1 942,25
14000 004465	24	41	54	90	25	875	1 942,25
14000 004466	25	42	54	90	25	890	1 942,25
14000 004467	26	43	54	90	25	910	1 942,25
14000 004468	27	44	54	90	25	870	1 942,25
14000 004469	28	45	54	90	25	890	1 961,50
14000 004470	29	47	54	90	15	900	1 961,50
14000 004471	30	48	54	90	28	910	1 961,50
14000 004472	32	51	54	90	28	955	1 1.036,50
14000 004473	33	51	54	92	28	1015	1 1.036,50
14000 004474	34	53	54	92	28	990	1 1.077,00
14000 004475	35	54	54	92	28	1020	1 1.144,25
14000 004476	36	56	54	92	32	1035	1 1.144,25
14000 004477	38	58	54	92	32	1050	1 1.307,75
14000 004478	41	61	54	92	32	1095	1 1.403,75
14000 004479	46	68	54	95	35	1330	1 1.615,50
14000 004480	50	73	54	95	35	1380	1 1.923,00
14000 004481	55	70	54	100	40	1705	1 2.500,00
14000 004482	60	86	54	100	42	2020	1 3.269,25
14000 004483	65	92	54	110	50	2135	1 4.250,00
14000 004484	70	97	54	110	59	2285	1 5.403,75
14000 004485	75	104	86	120	60	3400	1 6.384,50
14000 004486	80	110	86	120	60	4200	1 7.327,00
14000 004487	85	115	86	120	60	3980	1 12.019,25
14000 004488	90	122	86	125	65	5000	1 13.942,25

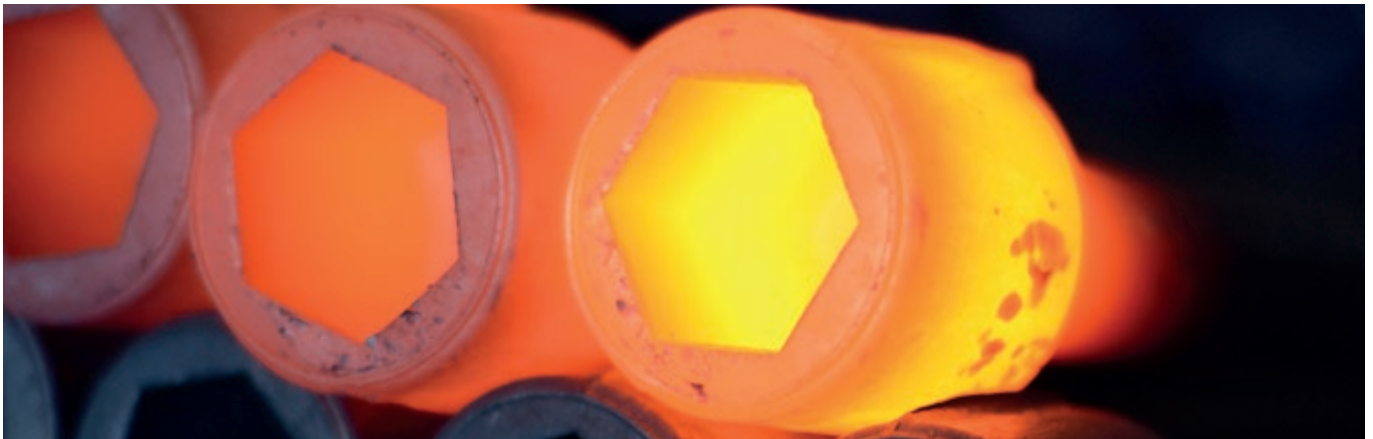

1525

1" Havalı Lokma Ara Kol
Impact Socket Extension Bar

TS ISO 1174-2



1"

Krom molibden, Fosfat kaplamalı
Chrom molybdenum, Phosphate finish

KOD CODE	L mm	g	TL/Ad.
1525 06 7175	175	1395	5 1.846,75
1525 06 7250	250	1890	5 2.373,25
1525 06 7330	330	2455	5 2.885,00

1525 06 7128

1" Havalı Lokma Mafsal
Impact Socket Universal Joint



1"

Krom molibden, Fosfat kaplamalı
Chrom molybdenum, Phosphate finish

KOD CODE	L mm	g	TL/Ad.
1525 06 7128	128	1530	1 3.443,50

1525 06 7015

1" Havalı Lokma Adaptörü
Impact Socket Adapter



1"

Krom molibden, Fosfat kaplamalı
Chrom molybdenum, Phosphate finish

KOD CODE	inch	g	TL/Ad.
1525 06 7015	1"Fx3/4"M	560	5 707,00





İZELTAS®

BORU ANAHTARLARI VE PENSELER

PIPE WRENCHES AND PLIERS

Boru Anahtarları
Pipe Wrenches

Fort Penseler
Water Pump Pliers

Ayarlı Penseler
Grip Wrenches

Penseler
Pliers

Kargaburunlar
Nose Pliers

Kerpetenler
Carpenter Pincers

Elektronikçi Penseler
Electronic Pliers



İZELTAS YOUTUBE

**Güçlü kavrama sağlayan
tırnaklı tutma yüzeyleri**
Toothed surface for strong grip

**Isıl işlem sonrasında indüksiyonda
sertleştirme ile kullanım ömrü
artırılmış kesici ağızlar**
Heat-treated and induction hardened
cutting edges for long lifetime

**Siyah fosfat kaplama ile
korozyon direnci**
High corrosion resistance
with manganese phosphate coating

**Yüksek karbonlu
sıcak dövme çeliği
ile arttırılmış
dayanım**
High carbon forged
steel for improved
durability

**Düşmelere ve darbeye dayanıklı,
P.P. ergonomik sap**
Impact resistant P.P. handle



2100

Stilson Boru Anahtarı
Pipe Wrench, Stilson



TS 3796



Yedek parça sayfa 242
Spare parts page 242

Krom vanadyum, Dişler indüksiyonda sertleştirilmiş, Elektrostatik boyanmış
Chrom vanadium, Teeth induction hardened, Electrostatically painted

KOD CODE	L mm	L inch	mm	ÖLÇÜ SIZE mm	g	TL/Ad.
2100 10 0008	200	8"	27	6-20	280	1 824,00
2100 10 0010	250	10"	34	6-26	550	1 991,25
2100 10 0012	300	12"	42	10-32	725	1 1.115,25
2100 10 0014	350	14"	50	13-38	1030	1 1.369,00
2100 10 0018	450	18"	60	26-52	1775	1 1.737,75
2100 10 0024	600	24"	76	38-65	2775	1 2.799,00

2201

Maşalı Boru Anahtarı (85°)
Pipe Wrench (85°)



TS 3796
DIN 5234



Yedek parça sayfa 242
Spare parts page 242

Krom vanadyum, Dişler indüksiyonda sertleştirilmiş, Elektrostatik boyanmış
Chrom vanadium, Teeth induction hardened, Electrostatically painted

KOD CODE	L mm	mm	ÖLÇÜ SIZE Inch	g	TL/Ad.
2201 10 0010	325	40	1"	870	1 839,00
2201 10 0015	430	60	1 1/2"	1585	1 1.299,50
2201 10 0020	585	70	2"	2700	1 1.945,50
2201 10 0030	690	100	3"	4270	1 2.949,00
2201 10 0040	760	130	4"	5800	1 4.422,50

2110

Ağır Tip Boru Anahtarı
Pipe Wrench, Heavy Duty



Yedek parça sayfa 242
Spare parts page 242

Krom vanadyum, Dişler indüksiyonda sertleştirilmiş, Elektrostatik boyanmış
Chrom vanadium, Teeth induction hardened, Electrostatically painted

KOD CODE	L mm	L inch	mm	ÖLÇÜ SIZE Inch	g	TL/Ad.
2110 10 0008	200	8"	34	1"	425	1 1.094,50
2110 10 0010	250	10"	42	1 1/4"	795	1 1.358,50
2110 10 0012	300	12"	50	1 1/2"	1245	1 1.555,50
2110 10 0014	350	14"	60	2"	1710	1 1.811,00
2110 10 0018	450	18"	75	2 1/2"	2685	1 2.526,75
2110 10 0024	600	24"	90	3"	4370	1 4.074,25
2110 10 0036	900	36"	140	5"	7600	1 9.023,00
2110 10 0048	1200	48"	165	6"	15600	1 18.479,75

Zincirli Boru Anahtarı
Chain Pipe Wrench



Yedek parça sayfa 242
Spare parts page 242

Dişler indüksiyonda sertleştirilmiş, Elektrostatik boyanmış
Teeth induction hardened, Electrostatically painted

KOD CODE	L mm	mm	ÖLÇÜ SIZE Inch	g	TL/Ad.
14000 005036	940	115	4"	4770	1 6.730,75
14000 005037	1125	165	6"	8580	1 9.134,50
14000 005140	1280	220	8"	12820	1 15.384,50

Zincirli Boru Anahtarı Yedek Zinciri
Spare Chain For Chain Pipe Wrench



KOD CODE	ÖLÇÜ SIZE Inch	L mm	g	TL/Ad.
14000 005039	4"	555	840	1 1.653,75
14000 005040	6"	785	1635	1 2.884,50
14000 005139	8"	990	2400	1 3.365,50

Üniversal Fort Pense
Waterpump Pliers UniversalTS 60 TS ISO 8976
DIN ISO 8976

IZELTAS YOUTUBE

Krom vanadyum, Krom kaplı, PVC izoleli
Chrom vanadium, Chrom plated, PVC insulated

KOD CODE	L mm	L inch	mm	g	TL/ Ad.
2400 11 0160	160	6 1/4"	30	125	5 514,00
2400 11 0240	240	9 1/2"	35	355	5 718,75
2400 11 0315	315	12 1/2"	40	530	5 1.177,00

2400 11 6240

1000V İzoleli Üniversal Fort Pense
Insulated Type Waterpump
Pliers Universal 1000VTS 60
TS ISO 8976
1000 V
IEC 60900**Krom vanadyum, Krom kaplı, çift komponent saplı**
Chrom vanadium, Chrom plated, Two component handle

KOD CODE	L mm	L inch	mm	g	TL/ Ad.
2400 11 6240	240	9 1/2"	35	370	5 833,75

Yaylı Fort Pense
Waterpump Pliers With SpringIZELTAS USTA İŞİ
SOHBETLER**Krom vanadyum, Karartma, PVC izoleli**
Chrom vanadium, Black finish, PVC insulated

KOD CODE	L mm	L inch	mm	g	TL/ Ad.
2415 11 0240	240	9 1/2"	35	365	5 969,25



2500 11 0250

Üniversal Ayarlı Pense
Universal Grip



Çeneler krom vanadyum çeliğinden dövülmüştür, Nikel kaplama,
Kullanım sahası: Yuvarlak ve düz malzemeler
Jaws Chrom vanadium forged, Nickel plated
Application field : Flat and round materials

KOD CODE	L mm	L inch	mm	g	TL/ Ad.
2500 11 0250	250	10"	30	560	5 856,00

2510 11 0250

Spesiyal Ayarlı Pense
Special Grip



Çeneler krom vanadyum çeliğinden dövülmüştür, Nikel kaplama,
Kullanım sahası: Yuvarlak ve düz malzemeler
Jaws Chrom vanadium forged, Nickel plated
Application field: Flat and round materials

KOD CODE	L mm	L inch	mm	g	TL/ Ad.
2510 11 0250	250	10"	30	550	5 856,00

2505 11 0250

Standart Ayarlı Pense
Standard Grip



Çeneler krom vanadyum çeliğinden dövülmüştür, Nikel kaplama
Kullanım sahası: Düz malzemeler
Jaws, Chrom vanadium forged, Nickel plated
Application field: Flat materials

KOD CODE	L mm	L inch	mm	g	TL/ Ad.
2505 11 0250	250	10"	30	535	5 856,00

2511 11 0280

C tipi Ayarlı Pense
Clamp Grip C-type



Çeneler krom vanadyum çeliğinden dövülmüştür, Nikel kaplama,
Kullanım sahası: Açılı profillerin tutulmasında
Jaws Chrom vanadium forged, Nickel plated
Application field: For Gripping angled sheet metal

KOD CODE	L mm	L inch	mm	g	TL/ Ad.
2511 11 0280	280	11"	70	700	1 1.430,75

2512 11 0200**Kaynakçı Ayarlı Pense (Düz Ağız)**
Lock Grip With Flat Jaws

Özel alaşımli çelikten imal edilmiş, Nikel kaplama,
Kullanım sahası: 80 mm düz çeneleri ile kıvrık metal levhaları
Made from special alloy steel, Nickel plated,
Application field: Gripping sheet metals with 80 mm Flat jaws

KOD CODE	L mm	L inch	mm	g	TL/Ad.
2512 11 0200	200	8"	30	485	1 1.444,00

2515 11 0270**Kaportacı Ayarlı Pense**
Welding Grip

Özel alaşımli çelikten imal edilmiş- Nikel kaplama,
Kullanım sahası: Yassı ve köşeli malzemelerde
Made from special alloy steel, Nickel plated
Application field : Angled corners and edges

KOD CODE	L mm	L inch	mm	g	TL/Ad.
2515 11 0270	270	10 5/8"	50	765	1 1.146,25

2513 11 0280**Kaynakçı Ayarlı Pense (Boru İçin)**
Grip For Tubes

Özel alaşımli çelikten imal edilmiş, Nikel kaplama,
Kullanım sahası: Boru malzemeler
Made from special alloy steel, Nickel plated,
Application field: Tubes

KOD CODE	L mm	L inch	mm	g	TL/Ad.
2513 11 0280	280	11"	50	800	1 1.444,00

13000 005519**1000V Çok Fonksiyonlu Elektrikçi Pense Yaylı**
Electrician Type Insulated Multi Function Spring
Pliers 1000V

⚡ 1000 V
IEC 60900

**YENİ
NEW**



Özel alaşımli çelik, Kesici ağzlar indüksiyonda sertleştirilmiş
Special steel, Cutters induction hardened

KOD CODE	L mm	L inch	g	TL/Ad.
13000 005519	215	8 15/32"	245	1 1.730,75

3020

Kombine Pense Opak Seri
Combination Pliers



TS 60
TS ISO 5746
DIN ISO 5746



Özel alaşımli çelik, Kesici ağızlar indüksiyonda sertleştirilmiş
Special steel, Cutters induction hardened

KOD CODE	L mm	L inch	g	TL/Ad.
3020 12 2160	160	6 1/4"	205	447,00
3020 12 2180	180	7 1/8"	275	507,25
3020 12 2200	200	8"	315	572,00

3020

Kombine Pense Kraft Seri
Combination Pliers



TS 60
TS ISO 5746
DIN ISO 5746



Özel alaşımli çelik, Kesici ağızlar indüksiyonda sertleştirilmiş
Special steel, Cutters induction hardened

KOD CODE	L mm	L inch	g	TL/Ad.
3020 12 3160	160	6 1/4"	225	547,50
3020 12 3180	180	7 1/8"	285	611,50
3020 12 3200	200	8"	380	691,00

3020

1000V İzoleli Elektrikçi Kombine Pense
Electrician Type Insulated
Combination Pliers 1000V

TS 60
TS ISO 5746
DIN ISO 5746
△ 1000 V
IEC 60900



Özel alaşımli çelik, Kesici ağızlar indüksiyonda sertleştirilmiş, Krom kaplı
Special steel, Cutters induction hardened, Chrom plated

KOD CODE	L mm	L inch	g	TL/Ad.
3020 12 6160	160	6 1/4"	205	614,75
3020 12 6180	180	7 1/8"	260	658,75
3020 12 6200	200	8"	345	743,00

13000 005118

Kombine Pense Black Line
Combination Pliers



TS 60
TS ISO 5746
DIN ISO 5746



Özel alaşımli çelik, Kesici ağızlar indüksiyonda sertleştirilmiş
Special steel, Cutters induction hardened

KOD CODE	L mm	L inch	g	TL/Ad.
13000 005118	180	7 1/8"	275	740,50

3030

Kombine Pense Ağır Tip (çelik tel için)
Combination Pliers Heavy Duty
(for piano wire)



Özel alaşımli çelik, Kesici ağızlar indüksiyonda sertleştirilmiş
Special steel, Cutters induction hardened

KOD CODE	L mm	L inch	g	TL/Ad.
3030 12 2180	180	7 1/8"	285	763,50
3030 12 2200	200	8"	380	873,50

3220

Kargaburun Düz Uçlu Opak Seri
Long Nose Pliers (Flat)



TS 60 - TS ISO 5745
DIN ISO 5745



İZELTAS YOUTUBE

Özel alaşımli çelik, Kesici ağızlar indüksiyonda sertleştirilmiş
Special steel, Cutters induction hardened

KOD CODE	L mm	L inch	g	□	TL/Ad.
3220 13 2140	140	5 1/2"	110	5	440,00
3220 13 2160	160	6 1/4"	135	5	497,75
3220 13 2180	180	7 1/8"	170	5	546,75
3220 13 2200	200	8"	205	5	579,75

3220

1000V İzoleli Elektrikçi Kargaburun Düz Uçlu
Insulated Electrician Type
Long Nose Pliers 1000V



TS 60
TS ISO 5745
DIN ISO 5745
△ 1000
IEC 60900



Özel alaşımli çelik, Kesici ağızlar indüksiyonda sertleştirilmiş, Krom kaplı
Special steel, Cutters induction hardened, Chrom plated

KOD CODE	L mm	L inch	g	□	TL/Ad.
3220 13 6140	140	5 1/2"	110	5	629,50
3220 13 6160	160	6 1/4"	140	5	695,75
3220 13 6180	180	7 1/8"	160	5	781,00
3220 13 6200	200	8"	170	5	811,25

3220

Kargaburun Düz Uçlu Kraft Seri
Long Nose Pliers (Flat)



TS 60 - TS ISO 5745
DIN ISO 5745



Özel alaşımli çelik, Kesici ağızlar indüksiyonda sertleştirilmiş
Special steel, Cutters induction hardened

KOD CODE	L mm	L inch	g	□	TL/Ad.
3220 13 3140	140	5 1/2"	120	5	543,25
3220 13 3160	160	6 1/4"	155	5	613,00
3220 13 3180	180	7 1/8"	185	5	674,50
3220 13 3200	200	8"	210	5	715,00

13000 005117

Düz Kargaburun Black Line
Long Nose Pliers (Flat)



TS 60 - TS ISO 5745
DIN ISO 5745



Özel alaşımli çelik, Kesici ağızlar indüksiyonda sertleştirilmiş
Special steel, Cutters induction hardened

KOD CODE	L mm	L inch	g	□	TL/Ad.
13000 005117	180	7 1/8"	170	5	878,75

3225

Kargaburun Eğri Uçlu Opak Seri
Long Nose Pliers (Bent)

TS 60 - TS ISO 5745



Özel alaşımlı çelik, Kesici ağızlar indüksiyonda sertleştirilmiş
Special steel, Cutters induction hardened

KOD CODE	L mm	L inch	g	TL/Ad.
3225 13 2160	160	6 1/4"	140	525,50
3225 13 2180	180	7 1/8"	170	594,00
3225 13 2200	200	8"	175	634,25

3225

Kargaburun Eğri Uçlu Kraft Seri
Long Nose Pliers (Bent)

TS 60 - TS ISO 5745



Özel alaşımlı çelik, Kesici ağızlar indüksiyonda sertleştirilmiş
Special steel, Cutters induction hardened

KOD CODE	L mm	L inch	g	TL/Ad.
3225 13 3160	160	6 1/4"	150	632,00
3225 13 3180	180	7 1/8"	190	694,00
3225 13 3200	200	8"	195	763,25

3020 00 2003

Opak Pense Seti 160mm (3 Parça)
Opak Pliers Set 160mm (3 Pcs)



KOD CODE	L mm	İÇERİK CONTENTS	TL Ad.
3020 12 2160	160	Kombine Pense Opak Seri Combination Pliers 160mm	1
3220 13 2160	160	Kargaburun Düz Uçlu Opak Seri Long Nose Pliers (Flat) 160mm	1
3700 16 2160	160	Yan Keski Opak Seri Side Cutting Pliers 160mm	1

3020 00 1002

Pense Kontrol Kalem Seti (2 Parça)
Opak Pliers Set, Voltage Tester (Flat) 2 Pcs



KOD CODE	L mm	İÇERİK CONTENTS	TL Ad.
3020 12 2160	160	Kombine Pense Opak Seri Combination Pliers 160mm	1
4550 17 0190	190	Elektrik Kontrol Kalem (Düz Uçlu) Voltage Tester (Flat) 190mm	1

3700

Yan Keski Opak Seri
Side Cutting Pliers



TS 60 - TS ISO 5749
DIN ISO 5749



Özel alaşımli çelik, Kesici ağızlar indüksiyonda sertleştirilmiş
Special steel, Cutters induction hardened

KOD CODE	L mm	L inch	g	□	TL/Ad.
3700 16 2140	140	5 1/2"	165	5	465,00
3700 16 2160	160	6 1/4"	230	5	560,00
3700 16 2180	180	7 1/8"	240	5	652,75

3700

Yan Keski Kraft Seri
Side Cutting Pliers



TS 60 - TS ISO 5749
DIN ISO 5749



Özel alaşımli çelik, Kesici ağızlar indüksiyonda sertleştirilmiş
Special steel, Cutters induction hardened

KOD CODE	L mm	L inch	g	□	TL/Ad.
3700 16 3140	140	5 1/2"	190	5	561,00
3700 16 3160	160	6 1/4"	240	5	673,50
3700 16 3180	180	7 1/8"	255	5	784,50

3700

1000V İzoleli Elektrikçi Yan Keski
Insulated Electrician Type Side Cutter 1000V

TS 60
TS ISO 5749
DIN ISO 5749
1000 V
IEC 60900



Özel alaşımli çelik, Kesici ağızlar indüksiyonda sertleştirilmiş, Krom kaplı
Special steel, Cutters induction hardened, Chrom plated

KOD CODE	L mm	L inch	g	□	TL/Ad.
3700 16 6140	140	5 1/2"	165	5	705,50
3700 16 6160	160	6 1/4"	215	5	800,75
3700 16 6180	180	7 1/8"	225	5	895,75

13000 005119

Yan Keski Black Line
Side Cutting Pliers



TS 60 - TS ISO 5749
DIN ISO 5749



Özel alaşımli çelik, Kesici ağızlar indüksiyonda sertleştirilmiş
Special steel, Cutters induction hardened

KOD CODE	L mm	L inch	g	□	TL/Ad.
13000 005119	160	6 1/4"	230	5	901,00

13000 005133

Black Line Set (5 Parça)
Black Line Set (5 Pcs)



KOD CODE	İÇERİK CONTENTS	☐	TL/Ad.
13000 005118	Kombine Pense 180 mm Combination Pliers	1	2.892,25
13000 005117	Kargaburun Düz Uçlu 180 mm Long Nose Pliers (Flat)	1	
13000 005119	Yan Keski 160 mm Side Cutting Pliers	1	
13000 005116	Düz Uçlu Tornavida 6x100 Screwdriver Flat	1	
13000 005120	Yıldız Uçlu Tornavida 6x100 Screwdriver Phillips	1	

İnce Uçlu Yan Keski (Plastikler İçin)
 Side Cutter For Plastics

 TS 60
 TS ISO 5749

 Özel alaşımlı çelik, Kesici ağızlar indüksiyonda sertleştirilmiş, PVC izoleli
 Special steel, Cutters induction hardened, PVC insulated

KOD CODE	L mm	L inch	g	TL/Ad.
3705 16 5160	160	6 1/4"	220	728,25

Yan Keski Ağır Tip (Çelik Tel İçin)
 Side Cutter Heavy Duty (for piano wire)

 Özel alaşımlı çelik, Kesici ağızlar indüksiyonda sertleştirilmiş
 Special steel, Cutters induction hardened

KOD CODE	L mm	L inch	g	TL/Ad.
3730 16 2160	160	6 1/4"	200	793,75
3730 16 2200	200	8"	320	1.031,50

Segman Pense Takımı (4 Parça)
 Circlip Pliers Set (4 Pcs)

İZELTAS YOUTUBE

KOD CODE	L mm	İÇERİK CONTENTS	TL/Ad.
3301 12 0180	180	Dış Segman Pense (Düz) Circlip Pliers, External (Flat)	1
3311 12 0170	170	Dış Segman Pense (Eğri) Circlip Pliers, External (Bent)	1
3321 12 0180	180	İç Segman Pense (Düz) Circlip Pliers, Internal (Flat)	1
3331 12 0170	170	İç Segman Pense (Eğri) Circlip Pliers, Internal (Bent)	1

 330112 0180
 Dış Segman Pense (Düz) ● 19-60

 3311 12 0170
 Dış Segman Pense (Eğri) ● 19-60

 3321 12 0180
 İç Segman Pense (Düz) ● 19-60

 3331 12 0170
 İç Segman Pense (Eğri) ● 19-60



3301

Dış Segman Pense (Düz)
Circlip Pliers, External (Flat)



TS 60
DIN 5254

Krom vanadyum, Krom kaplı, PVC izoleli
Chrom vanadium, Chrom plated, PVC insulated

KOD CODE	L mm		 g		TL/Ad.
3301 12 0140	140	10 - 25	90	5	525,25
3301 12 0180	180	19 - 60	195	5	554,00
3301 12 0225	225	40 - 100	235	5	692,00
3301 12 0295	295	85 - 140	445	5	1.173,00



3321

İç Segman Pense (Düz)
Circlip Pliers Internal (Flat)



TS 60
DIN 5256

Krom vanadyum, Krom kaplı, PVC izoleli
Chrom vanadium, Chrom plated, PVC insulated

KOD CODE	L mm		 g		TL/Ad.
3321 12 0140	140	12 - 25	100	5	483,75
3321 12 0180	180	19 - 60	185	5	510,25
3321 12 0225	225	40 - 100	250	5	635,00
3321 12 0310	310	85 - 140	445	5	1.089,50



3311

Dış Segman Pense (Eğri)
Circlip Pliers, External (Bent)



TS 60
DIN 5254

Krom vanadyum, Krom kaplı, PVC izoleli
Chrom vanadium, Chrom plated, PVC insulated

KOD CODE	L mm		 g		TL/Ad.
3311 12 0125	125	10 - 25	105	5	587,00
3311 12 0170	170	19 - 60	190	5	618,00
3311 12 0210	210	40 - 100	250	5	710,50
3311 12 0275	275	85 - 140	445	5	1.231,75



3331

İç Segman Pense (Eğri)
Circlip Pliers Internal (Bent)



TS 60
DIN 5256

Krom vanadyum, Krom kaplı, PVC izoleli
Chrom vanadium, Chrom plated, PVC insulated

KOD CODE	L mm		 g		TL/Ad.
3331 12 0130	130	12 - 25	105	5	520,00
3331 12 0170	170	19 - 60	185	5	547,50
3331 12 0210	210	40 - 100	250	5	683,00
3331 12 0290	290	85 - 140	440	5	1.172,00



3420 12 0220**Hortum Kelepçe Pensesi**
Hose Clamp Pliers

KOD CODE	L mm	L inch	g		TL/Ad.
3420 12 0220	220	8 3/4"	185	5	933,50

3425 12 0220**Hortum Kelepçe Pensesi (Sıkıştırma Tipi)**
Hose Clamp Pliers

KOD CODE	L mm	L inch	g		TL/Ad.
3425 12 0220	235	9 1/4"	355	5	956,50

3852 24 0225**Delik Zımba**
Revolving Punch PliersÖlçü / Size $\emptyset 2 - \emptyset 2.5 - \emptyset 3 - \emptyset 3.5 - \emptyset 4 - \emptyset 4.5$

KOD CODE	L mm	L inch	g		TL/Ad.
3852 24 0225	225	9"	270	5	653,50



3715 16 0165

Tek Ağızlı Kablo Kesici
Cable Cutter



Özel alaşımlı çelik, Kesici ağızlar indüksiyonda sertleştirilmiş, PVC izoleli
Special steel, Cutters induction hardened, PVC insulated

KOD CODE	L mm	L inch	g		TL/Ad.
3715 16 0165	165	6 1/4	210	5	600,25

3715 16 6165

1000V İzoleli Tek Ağızlı Kablo Kesici
Cable Cutter 1000V

⚡ 1000 V
IEC 60900



Özel alaşımlı çelik, Kesici ağızlar indüksiyonda sertleştirilmiş
Special steel, Cutters induction hardened

KOD CODE	L mm	L inch	g		TL/Ad.
3715 16 6165	165	6 1/4	230	5	707,25

Çift Ağzılı Kablo Kesici
Cable Cutter, Double Cutter**Testere Çaprazı**
Saw - Setting Pliers

TSEK



Özel alaşımli çelik, Kesici ağızlar indüksiyonda sertleştirilmiş, PVC izoleli
Special steel, Cutters induction hardened, PVC insulated

KOD CODE	L mm	L inch	g	TL/Ad.
3720 16 0220	200	8"	265	5 804,25

Özel alaşımli çelik, İndüksiyonda sertleştirilmiş,
Naturul Vernikli, PVC izoleli
Special steel, induction hardened, PVC insulated

KOD CODE	L mm	L inch	g	TL/Ad.
★ 3860 26 0180	180	7 1/8"	245	5 742,00



★ Stoklarla sınırlıdır / It is limited by stocks

3550 14 0125
Elektronikçi Yan Keski
 Electronic Diagonal Side Cutting Pliers

 Özel alaşımli çelik
 Special steel

KOD CODE	L mm	g	□	TL/Ad.
3550 14 0125	125	76	5	637,50

3553 14 0150
Elektronikçi Düz Uçlu Kargaburun
 Electronic Flat Nose Pliers

 Özel alaşımli çelik
 Special steel

KOD CODE	L mm	g	□	TL/Ad.
3553 14 0150	150	88	5	575,25

3551 14 0125
Elektronikçi Tepe Keski
 Electronic End Cutting Pliers

 Özel alaşımli çelik
 Special steel

KOD CODE	L mm	g	□	TL/Ad.
3551 14 0125	125	77	5	595,00

3554 14 0150
Elektronikçi Uzun Kargaburun
 Electronic Long Nose Pliers

 Özel alaşımli çelik
 Special steel

KOD CODE	L mm	g	□	TL/Ad.
3554 14 0150	150	88	5	575,25

3552 14 0125
Elektronikçi Yuvarlak Uçlu Kargaburun
 Electronic Round Nose Pliers

 Özel alaşımli çelik
 Special steel

KOD CODE	L mm	g	□	TL/Ad.
3552 14 0125	125	78	5	577,25

3555 14 0150
Elektronikçi Sivri Uçlu Düz Kargaburun
 Electronic Needle Flat Nose Pliers

 Özel alaşımli çelik
 Special steel

KOD CODE	L mm	g	□	TL/Ad.
3555 14 0150	150	86	5	575,25

3556 14 0150

Elektronikçi Sivri Uçlu Eğri Kargaburun
Electronic Needle Bent Nose Pliers



Özel alaşımli çelik
Special steel

KOD CODE	L mm	g	□	TL/Ad.
3556 14 0150	150	85	5	575,25

3557 14 0125

Elektronikçi Pense
Electronic Pliers



Özel alaşımli çelik
Special steel

KOD CODE	L mm	g	□	TL/Ad.
3557 14 0125	125	80	5	577,25

3560 00 2104

Elektronikçi Keski ve Pense Seti (4 Parça)
Electronic Cutter & Pliers Set (4 Pcs)



KOD CODE	L mm	İÇERİK CONTENTS	□	TL Ad.
3550 14 0125	125	Elektronikçi Yan Keski Electronic Diagonal Side Cutting Pliers	1	2.385,00
3551 14 0125	125	Elektronikçi Tepe Keski Electronic End Cutting Pliers	1	
3554 14 0150	150	Elektronikçi Uzun kargaburun Electronic Long Nose Pliers	1	
3557 14 0125	125	Elektronikçi Pense Electronic Pliers	1	

3565 00 2104

Elektronikçi Kargaburun Seti (4 Parça)
Electronic Long Nose Pliers Set (4 Pcs)



KOD CODE	L mm	İÇERİK CONTENTS	□	TL Ad.
3552 14 0125	125	Elektronikçi Yuvarlak Uçlu Kargaburun Electronic Round Nose Pliers	1	2.303,00
3553 14 0150	150	Elektronikçi Düz Uçlu Kargaburun Electronic Flat Nose Pliers	1	
3555 14 0150	150	Elektronikçi Sivri Uçlu Düz Kargaburun Electronic Needle Nose Pliers	1	
3556 14 0150	150	Elektronikçi Sivri Uçlu Eğri Kargaburun Electronic Bent Needle Nose Pliers	1	

3800
Kerpeten
Carpenter Pincers

 TS 60 - TS ISO 9243
DIN ISO 9243

Özel alaşımli çelik, Kesici ağızlar indüksiyonda sertleştirilmiş,
Mangan Fosfat Kaplı, PVC izoleli
Special steel, Cutters induction hardened, Black finish, PVC insulated

KOD CODE	L mm	L inch	g	TL/Ad.
3800 15 0160	160	6 1/4"	220	5 459,75
3800 15 0180	180	7 1/8"	295	5 475,75
3800 15 0200	200	8"	330	5 634,25
3800 15 0250	250	10"	530	5 691,00

3830
Betoncu Kerpeteni
Tower Pincers

 TS 60 - TS ISO 9242
DIN ISO 9242

Özel alaşımli çelik, Kesici ağızlar indüksiyonda sertleştirilmiş,
Mangan Fosfat Kaplı, PVC izoleli
Special steel, Cutters induction hardened, Black finish, PVC insulated

KOD CODE	L mm	L inch	g	TL/Ad.
3830 15 0225	225	9"	345	5 570,75
3830 15 0250	250	10"	395	5 630,50
3830 15 0280	280	11"	450	5 752,75

3831 15 0280
Betoncu Kerpeteni Yaylı
Tower Pincers with spring

 TS 60 - TS ISO 9242
DIN ISO 9242

Özel alaşımli çelik, Kesici ağızlar indüksiyonda sertleştirilmiş,
Mangan Fosfat Kaplı, PVC izoleli
Special steel, Cutters induction hardened, Black finish, PVC insulated

KOD CODE	L mm	L inch	g	TL/Ad.
3831 15 0280	280	11"	455	5 755,25

3835 15 0280
Ağır Tip Betoncu Kerpeteni
Heavy Tower Pincers

 TS 60 - TS ISO 9242
DIN ISO 9242

İZELTAS YOUTUBE

Özel alaşımli çelik, Kesici ağızlar indüksiyonda sertleştirilmiş,
Mangan Fosfat Kaplı, PVC izoleli
Special steel, Cutters induction hardened, Black finish, PVC insulated

KOD CODE	L mm	L inch	g	TL/Ad.
3835 15 0280	280	11"	400	5 748,75

3850 12 0200
Danallya
Shoemaker Pliers

Özel alaşımli çelik, İndüksiyonda sertleştirilmiş, Siyah Oksit kaplı
Special steel, Induction hardened, Black finish

KOD CODE	L mm	L inch	g	TL/Ad.
3850 12 0200	200	8"	360	5 929,75



IZELTAS®

1000V İZOLELİ ALETLER

1000V INSULATED TOOLS



İZELTAS YOUTUBE

VDE BELGELİ ÜRÜNLERİMİZ / VDE CERTIFIED PRODUCTS



- » El aletleri sektörünün lider markası İZELTAŞ'ın VDE belgeli ürünleri elektrik sektöründe fark yaratıyor.
- Bu ürünler elektrik sektöründe 1000V izolasyon sağlamak için özel olarak tasarlanmış yanmaz sapları ile kullanıcıya güven verir.
 - Elektrik akımının bulunduğu alanlarda güvenli kullanım sağlar.
 - Yanma, 1000V elektrik direnci, soğuk ve sıcak havalarda sap sökme deneyleri başta olmak üzere pek çok özel testten geçirilen ürünler, Alman VDE firmasından onaylıdır.
 - Ergonomik sap tasarımı ile tutuş ve kullanım kolaylığı sağlar.



- » As the leading brand in hand tools sector, CDE certified products of İZELTAŞ make a difference in electrical sector.
- These products assure the user with their handles specially designed to provide isolation up to 1000 V.
 - They provide safe use in areas with electrical current.
 - The products are certified by German VDE institution, being subjected to various tests particularly including fire resistance, 1000 V electrical resistance and handle detachment tests in hot and cold air conditions.
 - They provide ease of grip and use with an ergonomic design.



Çalışma sırasında nelere dikkat edilmelidir?

- Elektrik akımının var olduğu alanlarda yalnızca özel eğitilmiş ve alanında uzman kişiler çalışmalıdır.
- Her kullanım öncesinde VDE belgeli ürünlerde ve izolelerinde hasar olup olmadığı kontrol edilmelidir.
- VDE belgeli ürünler amacı dışında ya da birleştirilerek kullanılmamalıdır.
- VDE belgeli ürünler ile koruyucu ekipmanlarınızı da güvenlik amacıyla kullanmalısınız.



Important points for use

- Only specially trained and expert personnel should engage in work in areas with electrical current.
- Before each use VDE certified products and their isolation materials should be checked against damage.
- VDE certified products should not be used outside their purpose or in combination.
- Protective equipment should also be used to protect personnel in addition to VDE certified products.



**VDE belgeli ürünlerimiz,
ilgili uluslararası standartlara göre
kontrol edildikten sonra ek olarak
beş ayrı teste tabi tutulur**

**Our VDE certified products
are controlled in accord with the applicable
international standards and then are
subjected to five different tests:**

» 1- Voltaj Testi: 3 dakika boyunca 10.000V'a tabi tutulan izoleli el aletinde kaçak yada elektrik akımı atlama olmamalıdır.

» 1- Voltage Test: No residual current or electrical arc should be seen on the isolated hand tool subjected to 10,000 V for 3 minutes.

2- Soğuk Şoklama Testi : -24 derece 2 saat bekletilmiş (şoklanmış) el aletine 60-80 cm yükseklikten 600gr ağırlık ile darbeler uygulanır. İzolede kırılma ya da çatlama olmamalıdır.

2- Cold Shock Test: Hand tools left in -24 °C for 2 hours (shocked) are subjected to impacts with a 600 gr weight dropped from a height of 60-80 cm. No breakage or cracking should be seen on the isolation material.

3- Dayanıklılık Testi: +70 derece 1 hafta bekletilmiş el aletine 50kg yük ile sap sökme testi uygulanır. Sap yerinden çıkmamalıdır.

3- Durability Test: Hand tools left in +70 °C for 1 week are subjected to handle detachment test with a load of 50 kg. The handle should not detach.

4- Geçirgenlik Testi: 5000V elektrik akımına karşı 3 dakika boyunca 2kg sivri uçlu ağırlıkta baskı yapılarak elektrik verilir. Kaçak ya da elektrik atlama olmamalıdır.

4- Perviousness Test: Pointed tips under 2 kg load are used to apply 5000 V electrical current for 3 minutes. There should be no residual current or electrical arc.

5- Yanma Testi: Yüksek yoğunluktaki alev 20 saniye maruz bırakılarak teste tabi tutulur. Alevden uzaklaştırılan izole yanmaya devam etmemelidir.

5- Fire Test: The tool is subjected to high intensity flames for 20 seconds. After contact with the flame is ended the isolation material should not continue burning.





**Güçlü kavrama sağlayan
tırnaklı tutma yüzeyleri**
Toothed surface for strong grip

**Isıl işlem sonrasında indüksiyonda
sertleştirme ile kullanım
ömrü artırılmış kesici ağızlar**
Heat-treated and induction hardened cutting
edges for long lifetime

**Nikel üzerine krom kaplama ile
korozyon direncinde
üst seviye koruma**
High corrosion resistance
with chrome over nickel plating

**Yüksek karbonlu
sıcak dövme çeliği
ile artırılmış
dayanım**
High carbon forged steel
for improved durability

**VDE/GS belgeli, 1000V dayanımlı,
sert plastikten ve konforlu tutuş
sağlayan yumuşak elastomer
malzemeden imal edilmiş
dayanımı yüksek çift
komponentli ergonomik sap**
VDE/GS certified, insulated for 1000V
usage. Two component ergonomic
handle with high strength and
soft grip plastic



0255

Süper İzole Çatal Bir Ağız Anahtar (mm)
Single Ended Open Jaw Wrench
Super Insulated (mm)

⚡ 1000 V
IEC 60900



Krom vanadyum, Krom kaplı, Kalın PVC izoleli
Chrom vanadium, Chrom plated, Triple PVC insulated

KOD CODE	mm	L mm	g		TL/Ad.
0255 01 0010	10	110	40	10	213,75
0255 01 0011	11	120	45	10	226,00
0255 01 0012	12	130	50	10	236,50
0255 01 0013	13	140	60	10	254,25
0255 01 0014	14	155	75	10	263,50
0255 01 0017	17	170	100	10	323,25
0255 01 0019	19	185	150	10	379,50
0255 01 0022	22	200	200	10	510,25
0255 01 0024	24	220	280	10	624,50

0435

Süper İzoleli Yıldız Bir Ağız Anahtar (mm)
Single Ended Ring Wrench
Super Insulated (mm)

⚡ 1000 V
IEC 60900



Krom vanadyum, Krom kaplı, Kalın PVC izoleli
Chrom vanadium, Chrom plated, Triple PVC insulated

KOD CODE	mm	L mm	g		TL/Ad.
0435 03 0010	10	170	100	10	285,00
0435 03 0011	11	175	110	10	285,00
0435 03 0012	12	180	130	10	323,25
0435 03 0013	13	185	150	10	323,25
0435 03 0014	14	190	180	10	339,75
0435 03 0017	17	205	220	10	384,50
0435 03 0019	19	220	270	10	458,75
0435 03 0022	22	245	310	10	502,50
0435 03 0024	24	270	420	10	671,50

0600 01 0010

1000V İzoleli Kurbağacık Anahtar
Insulated Electrician Type Adjustable
Wrench 1000V

TS ISO 6787
⚡ 1000 V / IEC 60900



**YENİ
NEW**

Krom vanadyum, Krom kaplı, Kalın PVC izoleli
Chrom vanadium, Chrom plated, Triple PVC insulated

KOD CODE	L mm	L inch	a mm	g		TL/Ad.
0600 01 0010	260	10"	28	440	5	1.077,00

1000V 1/2" Altı Köşe Lokma Anahtar (mm)
Socket Wrench 6 Points 1000V (mm)

TS ISO 2725-1
DIN 3124

⚡ 1000 V
IEC 60900

**YENİ
NEW**



1/2"

Krom vanadyum, Krom kaplı
Chrom vanadium, Chrom plated

KOD CODE	mm	σ D1 mm	σ D2 mm	L mm	L1 mm	g		TL/Ad.
13000 005148	10	19,5	27	40	7	55	1	449,50
13000 005149	11	20,7	27	40	7	55	1	447,00
13000 005150	12	22	27	40	8	55	1	455,00
13000 005151	13	23,2	27	40	8	60	1	457,00
13000 005152	14	24,5	27	40	9	60	1	460,50
13000 005153	15	25,7	27	40	10	65	1	463,00
13000 005154	16	27	27	40	11	65	1	472,00
13000 005155	17	28,2	27	40	11	65	1	478,00
13000 005156	19	30,7	27	42	11	70	1	488,25
13000 005157	22	34,5	27	44	12	70	1	500,25
13000 005158	24	37	27	46	13	75	1	510,50
13000 005159	27	40,7	27	48	13	75	1	602,00

13000 005277

1000V 1/2" Cırcır Kolu (36 Diş)
Ratchet Handle 1000V (36 Teeth)

**YENİ
NEW**

⚡ 1000 V
IEC 60900

1/2"



KOD CODE	L mm	g		TL/Ad.
13000 005277	275	540	1	4.341,75

1000V Ara Kol Extension Bar 1000V

⚡ 1000 V
IEC 60900

**YENİ
NEW**



1/2"

Krom vanadyum, Krom kaplı
Chrom vanadium, Chrom plated

KOD CODE	L mm	g		TL/Ad.
13000 005262	75	140	1	1.150,75
13000 005263	125	215	1	1.275,50
13000 005264	250	420	1	1.732,50

13000 005519

1000V Çok Fonksiyonlu Elektrikçi Pense Yaylı Electrician Type Insulated Multi Function Spring Pliers 1000V

⚡ 1000 V
IEC 60900

**YENİ
NEW**



Krom vanadyum
Chrom vanadium

KOD CODE	L mm	L inch	g		TL/Ad.
13000 005519	215	8 15/32"	245	1	1.730,75

13000 005541

1/2" 1000V T Kol 1000V Sliding T - Handle

⚡ 1000 V
IEC 60900

**YENİ
NEW**



1/2"

Krom vanadyum, Krom kaplı
Chrom vanadium, Chrom plated

KOD CODE	L mm	g		TL/ Ad.
13000 005541	250	355	5	1.057,75

3715 16 6165

1000V İzoleli Tek Ağızlı Kablo Kesici Cable Cutter 1000V

⚡ 1000 V
IEC 60900



Özel alaşımli çelik, Kesici ağızlar indüksiyonda sertleştirilmiş
Special steel, Cutters induction hardened

KOD CODE	L mm	L inch	g		TL/Ad.
3715 16 6165	165	6 1/4	150	5	707,25

2400 11 6240

1000V İzoleli Üniversal Fort Pense Insulated Type Waterpump Pliers Universal 1000V

TS 60
TS ISO 8976
⚡ 1000 V
IEC 60900



Krom vanadyum, Krom kaplı, çift komponent saplı
Chrom vanadium, Chrom plated, Two component handle

KOD CODE	L mm	L inch	mm	g		TL/ Ad.
2400 11 6240	240	9 1/2"	35	370	5	833,75

03753 50 026

1000V Mekanik Kablo Sıyrıcı Mechanical Cable Stripper 1000V

**YENİ
NEW**



KOD CODE	ÖLÇÜ SIZE	g		TL/ Ad.
03753 50 026	0.2 / 6	105	5	1.182,75

3020
1000V İzoleli Elektrikçi Kombine Pense
 Insulated Electrician Type Combination Pliers 1000V

 TS 60
 TS ISO 5746
 DIN ISO 5746
 ⚡ 1000 V
 IEC 60900

 Özel alaşımli çelik, Kesici ağızlar indüksiyonda sertleştirilmiş, Krom kaplı
 Special steel, Cutters induction hardened, Chrom plated

KOD CODE	L mm	L inch	g	□	TL/Ad.
3020 12 6160	160	6 1/4"	205	5	614,75
3020 12 6180	180	7 1/8"	260	5	658,75
3020 12 6200	200	8"	345	5	743,00

3700
1000V İzoleli Elektrikçi Yan Keski
 Insulated Electrician Type Side Cutter 1000V

 TS 60
 TS ISO 5749
 DIN ISO 5749
 ⚡ 1000 V
 IEC 60900

 Özel alaşımli çelik, Kesici ağızlar indüksiyonda sertleştirilmiş, Krom kaplı
 Special steel, Cutters induction hardened, Chrom plated

KOD CODE	L mm	L inch	g	□	TL/Ad.
3700 16 6140	140	5 1/2"	165	5	705,50
3700 16 6160	160	6 1/4"	215	5	800,75
3700 16 6180	180	7 1/8"	225	5	895,75

3220
1000V İzoleli Elektrikçi Kargaburun Düz Uçlu
 Insulated Electrician Type Nose Pliers 1000V

 TS 60
 TS ISO 5745
 DIN ISO 5745
 ⚡ 1000 V
 IEC 60900

 Özel alaşımli çelik, Kesici ağızlar indüksiyonda sertleştirilmiş, Krom kaplı
 Special steel, Cutters induction hardened, Chrom plated

KOD CODE	L mm	L inch	g	□	TL/Ad.
3220 13 6140	140	5 1/2"	110	5	629,50
3220 13 6160	160	6 1/4"	140	5	695,75
3220 13 6180	180	7 1/8"	160	5	781,00
3220 13 6200	200	8"	170	5	811,25

3020 00 6003
1000V İzoleli Elektrikçi Seti (3 Parça)
 1000V Insulated Tool Set (3 Pcs)

KOD CODE	İÇERİK CONTENTS	□	TL/Ad.
3020 12 6160	160 mm 1000V İzoleli Elektrikçi Kombine Pense Insulated Electrician Type Combination Pliers	1	
3220 13 6160	160 mm 1000V İzoleli Elektrikçi Kargaburun Düz Uçlu Insulated Electrician Type Nose Pliers	1	2.111,25
3700 16 6160	160 mm 1000V İzoleli Elektrikçi Yan Keski Insulated Electrician Type Side Cutter	1	

4140

1000V İzoleli Elektrikçi Düz Uçlu Tornavida Insulated Electrician Type Flat Screwdriver 1000V

TS ISO 2380-1
DIN ISO 2380-1
⚡ 1000 V
IEC 60900

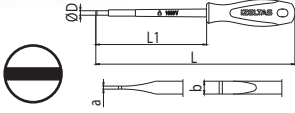

Krom vanadyum, Siyah oksit kaplı
Chrom vanadium, Black finish

KOD CODE	øDxL1 mm	⊖		L mm	g	□	TL/Ad.
		a mm	b mm				
4140 17 2575	2.5x75	0.4	2.5	150	25	10	101,25
4140 17 4100	4x100	0.8	4	185	40	10	118,50
4140 17 5512	5.5x125	1	5.5	220	70	10	156,50
4140 17 6515	6.5x150	1.2	6.5	245	90	10	174,50

4145

1000V İzoleli Elektrikçi Yıldız Uçlu Tornavida Insulated Electrician Type Phillips Screwdriver 1000V

TS 59-5 ISO 8764
DIN ISO 8764
⚡ 1000 V
IEC 60900

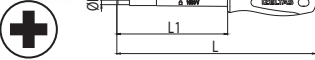

Krom vanadyum, Siyah oksit kaplı
Chrom vanadium, Black finish

KOD CODE	øDxL1 mm	+	L mm	g	□	TL/Ad.
4145 18 0360	3x60	Ph0	135	25	10	105,00
4145 18 4580	4.5x80	Ph1	165	45	10	148,50
4145 18 6100	6x100	Ph2	195	70	10	174,50

4140 00 9106

1000V İzoleli Elektrikçi Tornavida Seti (6 Parça) Insulated Electrician Set (6 Pcs) Screwdriver 1000V



KOD CODE	İÇERİK CONTENTS	g	□	TL/ Ad.
4140 00 9106	⊖ 2.5x75 - 4x100	340	6	873,75
	⊖ 5.5x125 - 6.5x150			
	⊕ Düz uçlu / Flat			
	⊕ 4.5x80 - 6x100			
	Yıldız uçlu / Phillips			

4773

1000V Süngüsü İzoleli Lokma Uçlu Tornavida Nut Spinner, Electrician Blade Insulated 1000V

⚡ 1000 V
IEC 60900

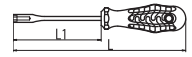

Krom vanadyum, iki komponent saplı
Chrome vanadium, Two component handle

KOD CODE	⊖ mm	L mm	L1 mm	g	□	TL/ Ad.
4773 19 0040	4	220	125	90	10	328,25
4773 19 0050	5	220	125	90	10	328,25
4773 19 0055	5.5	220	125	90	10	328,25
4773 19 0060	6	220	125	90	10	328,25
4773 19 0070	7	230	125	110	10	351,75
4773 19 0080	8	230	125	120	10	351,75
4773 19 0090	9	230	125	125	10	380,00
4773 19 0100	10	230	125	125	10	380,00
4773 19 0110	11	230	125	140	10	414,75
4773 19 0120	12	230	125	145	10	445,00
4773 19 0130	13	230	125	150	10	479,25
4773 19 0140	14	230	125	150	10	530,00

4773 00 8108

1000V Süngüsü İzoleli Lokma Uçlu Tornavida Takımı (8 Parça) Nut Spinner, Electrician Blade Insulated Set (8 Pcs) 1000V



KOD CODE	İÇERİK CONTENTS	g	□	TL/Ad.
4773 00 8108	6 - 7 - 8 - 9 - 10 - 11 - 12 - 13	2225	8	3.130,75

4783 19 6120

1000V Sngs İzoleli Manyetik Bits Tutucu Tornavida
Screwdriver, Magnetic Bit Holder Insulated 1000V

⚡ 1000 V
IEC 60900

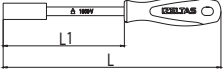

Krom vanadyum, iki komponent saplı
Chrome vanadium, Two component handle

KOD CODE	Ø mm	L mm	L1 mm	⚖ g	📦	TL/Ad.
4783 19 6120	6.3	230	120	115	10	369,25

8795 00 6005

1000V İzoleli Elektrikçi Seti (5 Parça)
1000V Insulated Tool Set (5 Pcs)



İZELTAS YOUTUBE

KOD CODE	İÇERİK CONTENTS	📦	TL/ Ad.
3020 12 6180	180 mm 1000V İzoleli Elektrikçi Kombine Pense Insulated Electrician Type Combination Pliers 1000V	1	
3220 13 6200	200 mm 1000V İzoleli Elektrikçi Kargaburun Insulated Electrician Type Nose Pliers	1	
3700 16 6160	160 mm 1000V İzoleli Elektrikçi Yan Keski Insulated Electrician Type Nose	1	2.601,75
4140 17 5512	5.5x125 1000V Elektrikçi Dz Uçlu Tornavida Insulated Electrician Type Flat Screwdriver 1000V	1	
4145 18 6100	6x100 1000V İzoleli Elektrikçi Yıldız Uçlu Tornavida Insulated Electrician Type Phillips Screwdriver 1000V	1	

8440 00 1023

19" Plastik Takım Çantası Elektrikçi Set (23 Parça)
Plastic Tool Box for Electrician 19" (23 Pcs)



KOD CODE	İÇERİK CONTENTS	📦	TL/ Ad.
8440 33 1019	19" Plastik Takım Çantası Plastic Tool Box	1	
3700 16 6160	160 mm 1000V İzoleli Elektrikçi Yan Keski Insulated Electrician Type Side Cutter 1000V	1	
3020 12 6180	180 mm 1000V İzoleli Elektrikçi Kombine Pense Insulated Electrician Type Combination Pliers 1000V	1	
3220 13 6160	160 mm 1000V İzoleli Elektrikçi Kargaburun Dz Uçlu Insulated Electrician Type Nose Pliers 1000V	1	
4773 19 0100	1000V Sngs İzoleli Lokma Uçlu Tornavida 10mm Nut Spinner, Electrician Blade Insulated 1000V	1	
4773 19 0130	1000V Sngs İzoleli Lokma Uçlu Tornavida 13mm Nut Spinner, Electrician Blade Insulated 1000V	1	
3715 16 6165	165mm 1000V İzoleli Elektrikçi Tek Ağız Kablo Kesici Cable Cutter 1000V	1	
4520 18 0360	3x60 Klemens Yıldız Tornavida Electronic Screwdriver, Phillips	1	6.020,50
4520 18 0480	4x80 Klemens Yıldız Tornavida Electronic Screwdriver, Phillips	1	
4500 17 0380	3x80 Klemens Dz Tornavida Electronic Screwdriver, Flat	1	
4500 17 0480	4x80 Klemens Dz Tornavida Electronic Screwdriver, Flat	1	
4140 17 4100	4x100 1000V İzoleli Elektrikçi Dz Tornavida Insulated Electrician Type Flat Screwdriver 1000V	1	
4145 18 4580	4,5x80 1000V İzoleli Elektrikçi Yıldız Tornavida Insulated Electrician Type Phillips Screwdriver 1000V	1	
4145 18 6100	6x100 1000V İzoleli Elektrikçi Yıldız Tornavida Insulated Electrician Type Phillips Screwdriver 1000V	1	
4550 17 0190	190 mm Kontrol Kalem Voltage Tester Flat	1	
4560 18 0190	190 mm Yıldız Kontrol Kalem Voltage Tester Phillips	1	
4783 19 6120	6.3x120 1000V İzoleli Elektrikçi Manyetik Bits Tutucu Tornavida Screwdriver, Magnetic Bit Holder Insulated 1000V	1	
4800 00 8106	6 İi Bits Set (25 mm) Bit Set 6 Pcs	6	



İZELTAS®

TORNAVİDA VE ALLEN ANAHTARLAR

SCREWDRIVERS AND HEX KEY WRENCHES

Tornavidalar
Screwdrivers

Kontrol Kalemleri
Testers

Bits Uçlar ve Aparatları
Bits

Allen Anahtarlar
Hex Key Wrenches



İZELTAS YOUTUBE

ELEKTRİK KONTROL KALEMİ / VOLTAGE TESTER

Tam sızdırmazlık sağlayan açılmayan pirinç kapak
Tightly pressed brass cover

110V-220V arasında çalışan elektrik direnci ve kolay görünebilen neon lamba
Neon lamp working in the range of 110V-220V

Elektrik yalıtkanlığı sağlayan, darbe dayanımı yüksek şeffaf sap
High insulation and impact resistant clear cellulose handle

İzoleli süngü
Insulated blade

Metal yüzeye basılı logo
Logo marked on the innermetal surface

Yüksek tork mukavemetine sahip, alaşımlı çelik (izolesiz uç kısmının uzunluğu 15mm)
High torque strength alloyed steel (non-insulated blade tip length 15mm)

Nikel kaplama ile korozyon direncinde üst seviye koruma
High corrosion resistance with nickel plating

Vida yuvalarına tam oturmayı sağlayan hassas işlenmiş uçlar
Precise machined slot to mate screw heads

4550
Elektrik Kontrol Kalemı (Düz Uçlu)
 Voltage Tester (Flat)

TS 13108

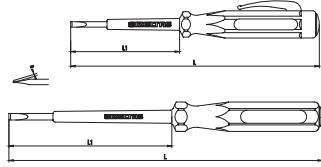
Krom vanadyum, Nikel kaplı
 Chrom vanadium, Nickel plated

KOD CODE	L mm	⊖		L1 mm	g	□	TL/ Ad.
		a mm	b mm				
4550 17 0135	135	0.5	3	60	20	10	93,50
4550 17 0190	190	0.8	4	100	40	10	119,75

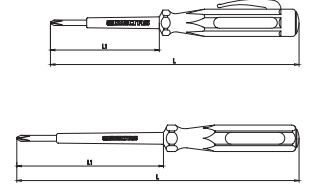
4560
Elektrik Kontrol Kalemı (Yıldız Uçlu)
 Voltage Tester (Phillips)

Krom vanadyum, Nikel kaplı
 Chrom vanadium, Nickel plated

KOD CODE	L mm	L1 mm	⊕	g	□	TL/ Ad.
4560 18 0190	190	100	Ph0	40	10	141,50

4555 17 0165
Master Elektrik Kontrol Kalemı (Düz Uçlu)
 Voltage Tester Master (Flat)

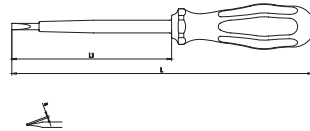
TS 13108

Krom vanadyum, Nikel kaplı
 Chrom vanadium, Nickel plated

KOD CODE	L mm	⊖		L1 mm	g	□	TL/ Ad.
		a mm	b mm				
★ 4555 17 0165	165	0.5	3.5	88	40	10	129,50

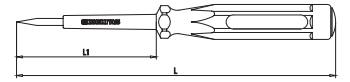
4565 17 0135
Oto Kontrol Kalemı
 Car Voltage Tester

Krom vanadyum, Krom kaplı
 Chrom vanadium, Chrom plated

Tüm otomobil ve ağır vasıta araçlarda 6-24V arası elektrik tesisatının kontrol edilmesinde kullanılır. Sivri uçlu olması sebebiyle kablo ve soketleri yerinden sökmeden kontrol kolaylığı sağlar.

Tool is used to control 6-24V electrical wiring in all cars and heavy duty vehicles. With its point tip, wires and sockets are not required to be disassembled.

KOD CODE	L mm	L1 mm	●	Kablo L (m)	g	□	TL/ Ad.

★ Stoklarla Sınırlıdır / It is Limited by Stocks.

Kraft Seri Düz Uçlu Tornavida
 Screwdriver, Kraft, Flat

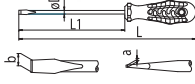
 TS ISO 2380 - 1
 DIN ISO 2380-1

 Krom vanadyum, Krom kaplı, Ucu siyah oksit, Selüloz asetat saplı
 Chrom vanadium, Chrom plated and black tip, Cellulose acetate handle

KOD CODE	øDxL1 mm	⊖		L mm	g	□	TL/Ad.
		a mm	b mm				
4100 17 0340	3x40	0.5	3	105	20	10	78,75
4100 17 0380	3x80	0.5	3	155	35	10	83,75
4100 17 0480	4x80	0.8	4	165	50	10	90,25
4100 17 4100	4x100	0.8	4	185	50	10	104,75
4100 17 0580	5x80	1.0	5.5	175	70	10	110,75
4100 17 5100	5x100	1.0	5.5	195	75	10	121,50
4100 17 5125	5x125	1.0	5.5	220	80	10	138,75
4100 17 5150	5x150	1.0	5.5	245	80	10	152,00
4100 17 6100	6x100	1.2	6.5	195	85	10	124,50
4100 17 6125	6x125	1.2	6.5	220	90	10	143,00
4100 17 6150	6x150	1.2	6.5	245	95	10	156,75
4100 17 6175	6x175	1.2	6.5	270	100	10	201,00
4100 17 7125	7x125	1.2	8	230	120	10	159,00
4100 17 7150	7x150	1.2	8	255	130	10	183,50
4100 17 7175	7x175	1.2	8	280	135	10	210,25
4100 17 8150	8x150	1.6	10	255	145	10	208,75
4100 17 8175	8x175	1.6	10	280	150	10	222,50
4100 17 8200	8x200	1.6	10	305	160	10	272,25
4100 17 9200	9x200	2.0	12	305	190	10	290,00
4100 17 1125	11x250	2.5	14	365	305	10	368,50

Kraft Seri Düz Uçlu Tornavida Takımı (8 Parça)
 Screwdriver, Flat, Kraft Set (8 Pcs)

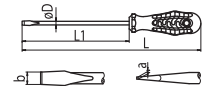
KOD CODE	İÇERİK CONTENTS	g	□	TL/ Ad.
4100 00 8108	3x80 - 4x80 - 4x100 5x100 - 5x125 - 6x100 6x125 - 6x150 ⊖ Düz uçlu / Flat	550	8	963,25

Kraft Seri Süngüsü Uzun Düz Uçlu Tornavida
 Screwdriver, Kraft, Flat, Long

 Krom vanadyum, Krom kaplı, Ucu siyah oksit, Selüloz asetat saplı
 Chrom vanadium, Chrom plated and black tip, Cellulose acetate handle

KOD CODE	øDxL1 mm	⊖		L mm	g	□	TL/Ad.
		a mm	b mm				
4100 17 4300	4x300	0.8	4	385	70	10	256,50
4100 17 5250	5x250	1.0	5.5	345	95	10	287,25
4100 17 5350	5x350	1.0	5.5	445	115	10	323,75
4100 17 6350	6x350	1.2	6.5	445	125	10	342,75

4120

Kraft Seri Yıldız Uçlu Tornavida
Screwdriver, Kraft, Phillips



TS 59 - 5 ISO 8764-1
DIN ISO 8764-1

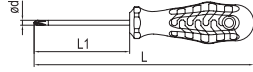

Krom vanadyum, Krom kaplı, Ucu siyah oksit, Selüloz asetat saplı
Chrom vanadium, Chrom plated and black tip, Cellulose acetate handle

KOD CODE	ødxL1 mm	+	L mm	g	□	TL/Ad.
4120 18 0360	3x60	Ph0	135	30	10	88,75
4120 18 4580	4.5x80	Ph1	165	55	10	127,75
4120 18 5100	4.5x100	Ph1	185	55	10	142,00
4120 18 5150	4.5x150	Ph1	235	60	10	169,75
4120 18 6100	6x100	Ph2	195	85	10	153,25
4120 18 6150	6x150	Ph2	245	95	10	183,50
4120 18 6200	6x200	Ph2	295	105	10	238,25
4120 18 8150	8x150	Ph3	255	150	10	290,75
4120 18 1200	10x200	Ph4	315	240	10	449,00

4120

Kraft Seri Süngüsü Uzun Yıldız Uçlu Tornavida
Screwdriver, Kraft, Phillips, Long

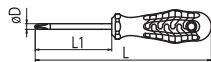

Krom vanadyum, Krom kaplı, Ucu siyah oksit, Selüloz asetat saplı
Chrom vanadium, Chrom plated and black tip, Cellulose acetate handle

KOD CODE	øDxL1 mm	+	L mm	g	□	TL/Ad.
4120 18 5300	4.5x300	Ph1	385	80	10	400,75
4120 18 6300	6x300	Ph2	395	125	10	414,25

4120 00 8106

Kraft Seri Yıldız Uçlu Tornavida Takımı (6 parça)
Screwdriver, Kraft, Phillips, Set (6 Pcs)



KOD CODE	İÇERİK CONTENTS	g	□	TL/Ad.
4120 00 8106	3x60 - 4.5x80 4.5x100 - 4.5x150 6x100 - 6x150 Yıldız uçlu / Phillips	380	6	865,00

4100 00 8107

Kraft Seri Tornavida Seti (7 parça)
Screwdriver Set, Kraft (7 Pcs)

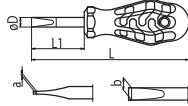

KOD CODE	İÇERİK CONTENTS	g	□	TL/Ad.
4100 00 8107	3x80 - 4x80 - 4x100 5x125 - 6x150 Düz uçlu / Flat 4.5x80 - 6x100 Yıldız uçlu / Phillips	445	7	855,25

Kraft Seri Düz Uçlu Topaç Tornavida
 Screwdriver, Kraft, Stubby, Flat

Krom vanadyum, Krom kaplı, Ucu siyah oksit, Selüloz asetat saplı
 Chrom vanadium, Chrom plated and black tip, Cellulose acetate handle

KOD CODE	øDxL1 mm	⊖		L mm	g	TL/Ad.
		a mm	b mm			
4110 17 5525	5.5x25	1	5.5	70	30	5 90,75
4110 17 5540	5.5x40	1	5.5	105	45	5 122,50
4110 17 6525	6.5x25	1.2	6.5	70	35	5 101,25
4110 17 6540	6.5x40	1.2	6.5	105	50	5 138,75

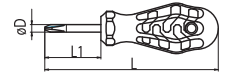
Kraft Seri Yıldız Uçlu Topaç Tornavida
 Screwdriver, Kraft, Stubby, Phillips

Krom vanadyum, Krom kaplı, Ucu siyah oksit, Selüloz asetat saplı
 Chrom vanadium, Chrom plated and black tip, Cellulose acetate handle

KOD CODE	øDxL1 mm	+	L mm	g	TL/Ad.
4130 18 4540	4.5x40	Ph1	105	40	5 122,00
4130 18 0625	6x25	Ph2	70	30	5 101,50
4130 18 0640	6x40	Ph2	105	50	5 137,50

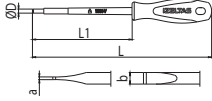

4140
1000V İzoleli Elektrikçi Düz Uçlu Tornavida
 Insulated Electrician Type Flat
 Screwdriver 1000V

 TS ISO 2380-1
 DIN ISO 2380-1
 ⚡ 1000 V
 IEC 60900

 Krom vanadyum, Siyah oksit kaplı
 Chrom vanadium, Black finish

KOD CODE	σDxL1 mm	⊖		L mm	g	□	TL/Ad.
		a mm	b mm				
4140 17 2575	2.5x75	0.4	2.5	150	25	10	101,25
4140 17 4100	4x100	0.8	4	185	40	10	118,50
4140 17 5512	5.5x125	1	5.5	220	70	10	156,50
4140 17 6515	6.5x150	1.2	6.5	245	90	10	174,50

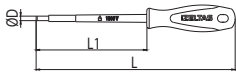
4145
1000V İzoleli Elektrikçi Yıldız Uçlu Tornavida
 Insulated Electrician Type Phillips
 Screwdriver 1000V

 TS 59-5ISO 8764
 DIN ISO 8764
 ⚡ 1000 V
 IEC 60900

 Krom vanadyum, Siyah oksit kaplı
 Chrom vanadium, Black finish

KOD CODE	σDxL1 mm	+	L mm	g	□	TL/Ad.
4145 18 4580	4.5x80	Ph1	165	45	10	148,50
4145 18 6100	6x100	Ph2	195	70	10	174,50

4140 00 9106
1000V İzoleli Elektrikçi Tornavida Seti (6 Parça)
 Insulated Electrician Set (6 Pcs) Screwdriver 1000V

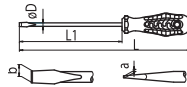

KOD CODE	İÇERİK CONTENTS	g	□	TL/ Ad.
4140 00 9106	2.5x75 - 4x100	340	6	873,75
	⊖ 5.5x125 - 6.5x150			
	Düz uçlu / Flat			
	⊕ 4.5x80 - 6x100			
	Yıldız uçlu / Phillips			

13000 005116
Black Line Düz Uçlu Tornavida
 Screwdriver, Flat

 TS ISO 2380-1
 DIN ISO 2380-1

 Krom vanadyum, Krom kaplı, Ucu siyah oksit, PP saplı
 Chrome vanadium, Chrom plated and black tip, PP handle

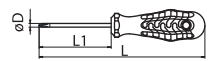
KOD CODE	σDxL1 mm	⊖		L mm	g	□	TL/Ad.
		a mm	b mm				
13000 005116	6x100	1.2	6.5	195	65	10	176,00

1300 005120
Black Line Yıldız Uçlu Tornavida
 Screwdriver, Phillips

 TS 59 - 5 ISO 8764-1
 DIN ISO 8764

 Krom vanadyum, Krom kaplı, Ucu siyah oksit, PP saplı
 Chrome vanadium, Chrom plated and black tip, PP handle

KOD CODE	σdxL1 mm	+	L mm	g	□	TL/Ad.
13000 005120	6x100	Ph2	195	70	10	196,25

4300

Opak Seri Düz Uçlu Tornavida
Screwdriver, Opak, Flat



TS ISO 2380-1
DIN ISO 2380-1



Krom vanadyum, Krom kaplı, Ucu siyah oksit, PP saplı
Chrome vanadium, Chrom plated and black tip, PP handle

KOD CODE	σDxL1 mm	⊖		L mm	g	□	TL/Ad.
		a mm	b mm				
4300 17 0380	3x80	0.5	3	155	25	10	73,75
4300 17 0480	4x80	0.8	4	165	35	10	76,25
4300 17 4100	4x100	0.8	4	185	40	10	90,75
4300 17 5100	5x100	1.0	5.5	195	60	10	109,50
4300 17 5125	5x125	1.0	5.5	220	60	10	127,75
4300 17 6100	6x100	1.2	6.5	195	65	10	114,00
4300 17 6125	6x125	1.2	6.5	220	70	10	130,00
4300 17 6150	6x150	1.2	6.5	245	80	10	142,00
4300 17 7125	7x125	1.2	8	230	95	10	145,50
4300 17 7150	7x150	1.2	8	255	105	10	167,25
4300 17 8175	8x175	1.6	10	280	130	10	202,75
4300 17 9200	9x200	2.0	12	305	165	10	267,75

4320

Opak Seri Yıldız Uçlu Tornavida
Screwdriver, Opak, Phillips



TS 59 - 5 ISO 8764-1
DIN ISO 8764



Krom vanadyum, Krom kaplı, Ucu siyah oksit, PP saplı
Chrome vanadium, Chrom plated and black tip, PP handle

KOD CODE	σDxL1 mm	+	L mm	g	□	TL/Ad.
4320 18 4580	4.5x80	Ph1	165	40	10	115,50
4320 18 6100	6x100	Ph2	195	70	10	139,75
4320 18 8150	8x150	Ph3	255	140	10	264,50

4300 00 8107

Opak Seri Tornavida Seti (7 Parça)
Screwdriver Set, Opak (7 Pcs)



KOD CODE	İÇERİK CONTENTS	g	□	TL/Ad.

4325

Opak Seri Pozidriv Yıldız Uçlu Tornavida
Screwdriver, Opak, Pozidriv

TS 59 - 5 ISO 8764-1
DIN ISO 8764



Krom vanadyum, Krom kaplı, Ucu siyah oksit, PP saplı
Chrome vanadium, Chrom plated and black tip, PP handle

KOD CODE	σDxL1 mm	+	L mm	g	□	TL/Ad.
4325 18 4580	4.5x80	Pz1	165	40	10	127,75
4325 18 6100	6x100	Pz2	195	70	10	153,25
4325 18 8150	8x150	Pz3	255	140	10	290,75

4240 17 0680

Değişken Uçlu Tornavida Screwdriver - Reversible

TSEK



Krom vanadyum, Krom kaplı, Selüloz asetat saplı
Chrom vanadium, Chrom plated, Cellulose acetate handle

KOD CODE	øDxL1 mm	axb mm	+	L mm	g	TL/Ad.	
4240 17 0680	6x80	1.2x6	Ph2	175	80	10	160,25

4240 00 7102

Değişken Uçlu Tornavida Takımı Screwdriver Set - Reversible

TSEK



KOD CODE	øDxL1 mm	axb mm	+	L mm	g	TL/Ad.	
4240 00 7102	6x80	1.2x6	Ph2	175	105	1	274,75
	4.5x80	0.65x4.5	Ph1				

4500

Elektronikçi Tip (Klemens) Düz Uçlu Tornavida Electronic Screwdriver, Flat



Krom vanadyum, Krom kaplı, Ucu siyah oksit, PP saplı
Chrome vanadium, Chrom plated and black tip, PP handle

KOD CODE	øDxL1 mm	-		L mm	g	TL/Ad.	
		a mm	b mm				
4500 17 2560	2.5x60	0.4	2.5	140	15	10	71,25
4500 17 2580	2.5x80	0.4	2.5	160	15	10	74,75
4500 17 0380	3x80	0.5	3	160	15	10	79,25
4500 17 3100	3x100	0.5	3	180	20	10	96,75
4500 17 3125	3x125	0.5	3	205	20	10	127,75
4500 17 3510	3.5x100	0.6	3.5	180	20	10	99,50
4500 17 0480	4x80	0.8	4	160	20	10	81,50
4500 17 4100	4x100	0.8	4	180	20	10	99,50
4500 17 4125	4x125	0.8	4	205	25	10	134,00
4500 17 4150	4x150	0.8	4	230	25	10	145,75

4520

Elektronikçi Tip (Klemens) Yıldız Uçlu Tornavida Electronic Screwdriver, Phillips



Krom vanadyum, Krom kaplı, Ucu siyah oksit, PP saplı
Chrome vanadium, Chrom plated and black tip, PP handle

KOD CODE	øDxL1 mm	+	L mm	g	TL/Ad.	
4520 18 0360	3x60	Ph0	140	15	10	83,75
4520 18 0480	4x80	Ph0	160	20	10	120,00
4520 18 4150	4x150	Ph0	230	25	10	160,00

4500 00 8106

Elektronikçi Tip (Klemens) Tornavida Seti (6 Parça) Electronic Screwdriver Set (6 Pcs)



KOD CODE	İÇERİK CONTENTS	g	TL/Ad.
4500 00 8106	3x80 - 3x100	115	6
	3x125 - 4x150		
	Düz uçlu / Flat		
	3x60 - 4x80		
	Yıldız uçlu / Phillips		653,25

4530

Elektronikçi Tip (Klemens) Torx® Uçlu Tornavida
Electronic Screwdriver, Torx®

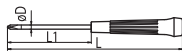

Krom vanadyum, Krom kaplı, Ucu siyah oksit, PP saplı
Chrome vanadium, Chrom plated and black tip, PP handle

KOD CODE	ØDxL1 mm	★	L mm	g	□	TL/Ad.
4530 17 0560	2.5x60	T5	145	15	10	96,75
4530 17 0660	2.5x60	T6	145	15	10	96,75
4530 17 0760	3x60	T7	145	15	10	100,25
4530 17 0860	3x60	T8	145	20	10	100,25
4530 17 0960	3x60	T9	145	20	10	100,25
4530 17 1060	3.5x60	T10	145	20	10	100,25

4530 00 0106

Elektronikçi Tip (Klemens) Torx® Uçlu Tornavida Takımı (6 Parça)
Electronic Screwdriver Set Torx (6 Pcs)



KOD CODE	İÇERİK CONTENTS	g	□	TL/Ad.
4530 00 1006	T5 - T6 - T7 - T8 - T9 - T10	115	6	594,50

4540 19 0190

Klips Sökme Tornavidası
Hupcap and Clip Remover

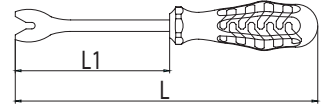

Krom vanadyum, Krom kaplı, PP Saplı
Chrom vanadium, Chrom plated, PP insulated

KOD CODE	L mm	L1	g	□	TL/Ad.
4540 19 0190	290	180	160	10	376,50

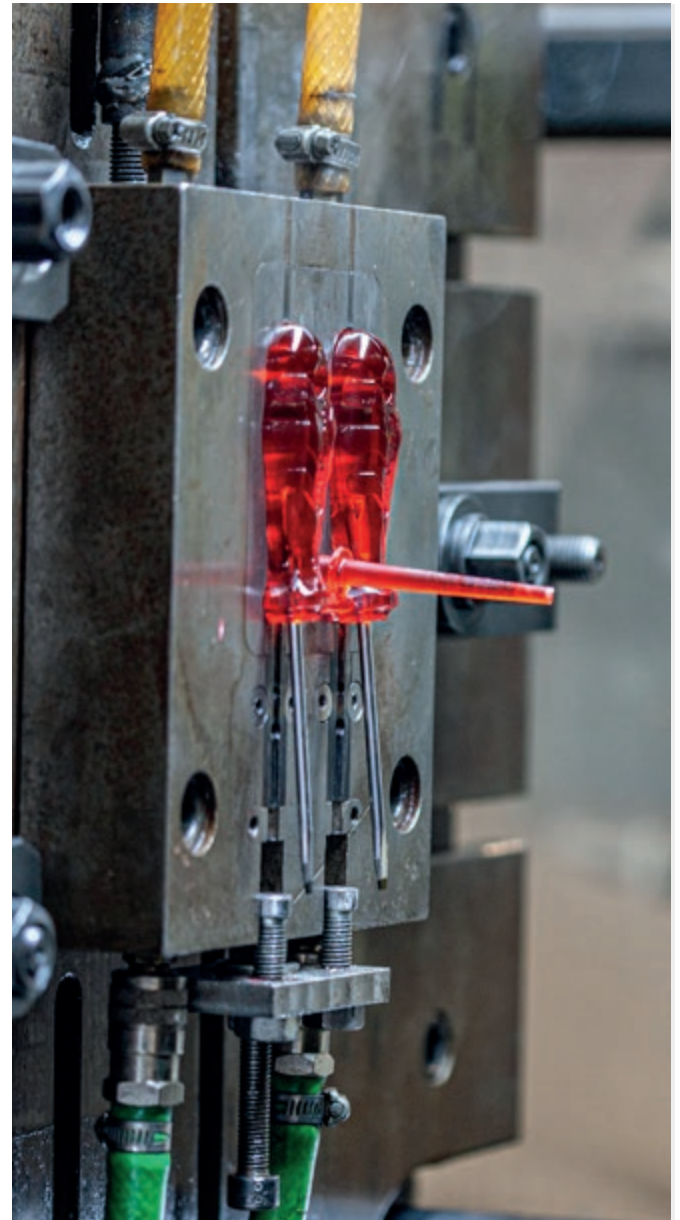

4765

T Tipi Lokma Uçlu Tornavida (mm)
Nut Spinner With T-Handle (mm)

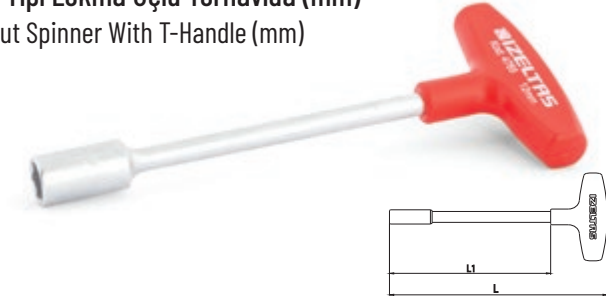

Krom vanadyum, Krom kaplı, PP Saplı
Chrom vanadium, Chrom plated, PP insulated

KOD CODE	mm	L mm	L1 mm	g		TL/ Ad.
4765 19 0040	4	185	135	75	10	203,50
4765 19 0050	5	185	135	75	10	203,50
4765 19 0055	5.5	185	135	75	10	203,50
4765 19 0060	6	185	135	75	10	203,50
4765 19 0070	7	185	135	90	10	217,00
4765 19 0080	8	185	135	95	10	217,00
4765 19 0090	9	185	135	100	10	241,00
4765 19 0100	10	185	135	100	10	241,00
4765 19 0110	11	185	135	110	10	266,25
4765 19 0120	12	185	135	110	10	274,75
4765 19 0130	13	185	135	115	10	287,50
4765 19 0140	14	185	135	115	10	334,00

4770

Lokma Uçlu Tornavida (mm)
Nut Spinner (mm)

TS 3793
DIN 3125



Krom vanadyum, Krom kaplı, PP Saplı
Chrom vanadium, Chrom plated, PP insulated

KOD CODE	mm	L mm	L1 mm	g		TL/ Ad.
4770 19 0040	4	220	125	80	10	231,25
4770 19 0050	5	220	125	80	10	231,25
4770 19 0055	5.5	220	125	80	10	231,25
4770 19 0060	6	220	125	80	10	231,25
4770 19 0070	7	230	125	100	10	248,50
4770 19 0080	8	230	125	110	10	248,50
4770 19 0090	9	230	125	115	10	268,00
4770 19 0100	10	230	125	115	10	268,00
4770 19 0110	11	230	125	130	10	293,00
4770 19 0120	12	230	125	135	10	314,00
4770 19 0130	13	230	125	140	10	338,25
4770 19 0140	14	230	125	140	10	374,00



4770 00 8108

Lokma Uçlu Tornavida Takımı (8 Parça, mm)
Nut Spinner Set (8 Pcs, mm)



KOD CODE	İÇERİK CONTENTS	g		TL/Ad.
4770 00 8108	6 - 7 - 8 - 9 - 10 - 11 - 12 - 13	2145	8	2.209,50

4773
1000V Sngs İzoleli Lokma Uçlu Tornavida (mm)

Nut Spinner, Electrician Blade Insulated 1000V

 ⚡ 1000 V
IEC 60900

Krom vanadyum, İki Komponent Saplı
 Chrome vanadium, Two Component Insulated

KOD CODE	mm	L mm	L1 mm	g	TL/Ad.	
4773 19 0040	4	220	125	90	10	328,25
4773 19 0050	5	220	125	90	10	328,25
4773 19 0055	5.5	220	125	90	10	328,25
4773 19 0060	6	220	125	90	10	328,25
4773 19 0070	7	230	125	110	10	351,75
4773 19 0080	8	230	125	120	10	351,75
4773 19 0090	9	230	125	125	10	380,00
4773 19 0100	10	230	125	125	10	380,00
4773 19 0110	11	230	125	140	10	414,75
4773 19 0120	12	230	125	145	10	445,00
4773 19 0130	13	230	125	150	10	479,25
4773 19 0140	14	230	125	150	10	530,00

4773 00 8108
1000V Sngs İzoleli Lokma Uçlu Tornavida Takımı (8 Parça, mm)

Nut Spinner, Electrician Blade Insulated Set (8 Pcs) 1000V



KOD CODE	İÇERİK CONTENTS	g	TL/Ad.	
4773 00 8108	6 - 7 - 8 - 9 - 10 - 11 - 12 - 13	2225	8	3.130,75

4775
Torx® Uçlu Tornavida

Torx® Screwdriver

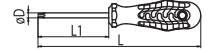
Krom vanadyum, Krom kaplı, Ucu siyah oksit, PP saplı
 Chrome vanadium, Chrom plated and blackened, PP handle

KOD CODE	øDxL1 mm	TL/Ad.	L mm	g	TL/Ad.	
4775 18 0010	4x80	T10	165	35	10	115,25
4775 18 0015	4x80	T15	165	35	10	115,25
4775 18 0020	4x100	T20	185	40	10	127,75
4775 18 0025	4.5x100	T25	185	40	10	147,75
4775 18 0027	5x125	T27	220	60	10	162,75
4775 18 0030	6x125	T30	220	70	10	172,75
4775 18 0040	7x125	T40	230	100	10	215,00
4775 18 0045	8x125	T45	230	120	10	242,75

4775 008107
Torx® Uçlu Tornavida Takımı (7 Parça)

Torx® Screwdriver Set (7 Pcs)



KOD CODE	İÇERİK CONTENTS	g	TL/Ad.	
4775 00 8107	T10 - T15 - T20 - T25 - T27 - T30 - T40	380	7	1.056,50

4776

Delikli Torx® Uçlu Tornavida
Torx® Screwdriver / Tamper Resistance

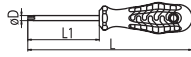

Krom vanadyum, Krom kaplı, Ucu siyah oksit, PP saplı
Chrome vanadium, Chrom plated and blackened, PP handle

KOD CODE	ØDxL1 mm	☆	L mm	g	□	TL/Ad.
4776 18 0009	4x60	TR9	145	35	10	149,25
4776 18 0010	4x80	TR10	165	35	10	154,50
4776 18 0015	4x80	TR15	165	40	10	154,50
4776 18 0020	4x100	TR20	185	40	10	172,25
4776 18 0025	4.5x100	TR25	185	45	10	198,50
4776 18 0027	5x125	TR27	220	60	10	219,00
4776 18 0030	6x125	TR30	220	70	10	233,00
4776 18 0040	7x125	TR40	230	100	10	288,50

4776 00 8107

Delikli Torx® Uçlu Tornavida Takımı (7 Parça)
Torx® Screwdriver / Tamper Resistance Set (7 Pcs)



KOD CODE	İÇERİK CONTENTS	g	□	TL/Ad.
4776 00 8107	TR10 - TR15 - TR20 - TR25 - TR27 TR30 - TR40	380	7	1.420,25

4780 19 6120

Manyetik Bits Tutucu Tornavida (Uzun)
Screwdriver, Magnetic Bit Holder (Long)



KOD CODE	mm	L mm	L1 mm	g	□	TL/Ad.
4780 19 6120	6.3	230	120	105	10	298,25

4783 19 6120

1000V Süngüsü İzoleli Manyetik Bits Tutucu Tornavida
Screwdriver, Magnetic Bit Holder Insulated 1000V

1000 V
IEC 60900



KOD CODE	mm	L mm	L1 mm	g	□	TL/Ad.
4783 19 6120	6.3	230	120	115	10	369,25

4785 19 6330

Manyetik Bits Tutucu Tornavida (Kısa)
Screwdriver, Magnetic Bit Holder, (Short)



KOD CODE	mm	L mm	L1 mm	g	□	TL/Ad.
4785 19 6330	6.3	130	30	60	10	162,75

4790 19 6360

Üniversal Bits Adaptörü (Manyetik)
Screwdriver Universal Bit Holder (Magnetic)



KOD CODE	mm	mm	L mm	g	□	TL/Ad.
4790 19 6360	6.3	6.3	60	25	10	142,25

4795 10 0010

T Tipi Manyetik Bits Tutucu Tornavida
Magnetic Bit Holder With T-Handle



KOD CODE	mm	L mm	L1 mm	g		TL/Ad.
4795 19 0010	6.3	180	130	60	10	316,00

4788 19 6160

Manyetik Bits Tutucu Tornavida, Flexible
Screwdriver, Magnetic Bit Holder, Flexible



KOD CODE	mm	L mm	L1 mm	g		TL/Ad.
4788 19 6160	6.3	285	175	130	10	618,25

4805

Bits Uç Lokma Adaptörü (Makine Kullanımına Uygun)
Socket Adapter



KOD CODE		L mm	g		TL/Ad.
4805 20 5010	1/4"M - 1/4"M	50	20	10	51,50
★ 4805 20 5011	1/4"M - 1/2"M	50	25	10	104,00

4815 00 6107

Değişken Bits Uçlu Tornavida Set (7 parça)
Screwdriver - Interchangeable Bits Set (7 pcs)



KOD CODE	İÇERİK CONTENTS	g		TL/Ad.
4815 00 6107	100mm Sap - Handle Ph1x4.5 - Ph2x5.5 - Ph3x7 Pz1x4.5 - Pz2x5.5 - Pz3x7	140	7	343,00

4800 00 8106

6'lı Bits Set
Bit Set (6 Pcs)



KOD CODE	İÇERİK CONTENTS	g		TL/Ad.
4800 00 8106	0.6x4.5 - 0.8x5.5	50	6	117,50
	Ph1 - Ph2 - Ph3			
	T27			

4800 00 8110

10'lu Bits Set
Bit Set (10 Pcs)



KOD CODE	İÇERİK CONTENTS	g		TL/Ad.
4800 00 8110	0.6x4.5 - 0.8x5.5 1.2x6.5	55	10	217,25
	Ph1 - Ph2 - Ph3			
	T25 - T27 - T30 - T40			

4800 00 8131

31'li Bits Set (Plastik Kutulu)
Bit Set In Plastic Case (31 Pcs)





KOD CODE	İÇERİK CONTENTS	g		TL/Ad.
4800 00 8131	0.6x4.5 - 0.8x5.5	240	6 - 6	729,75
	1.2x6.5			
	Ph1			
	Ph2 - Ph3			
	T27			
	T25 - T30 - T40			
	6.3 x 60 Adaptör			

★ Stoklarla Sınırlıdır / It is Limited by Stocks.

13000 005429

Cırcırlı Manyetik Bits Tutucu Tornavida Seti (8 Parça)
Multi Bit Ratcheting Screwdriver Set (8 Pcs)



KOD CODE	İÇERİK CONTENTS	g		TL/Ad.
	6'lı Bits Set Bit Set (6 Pcs)			
	 0.6x4.5 - 0.8x5.5		6	
	 Ph1 - Ph2 - Ph3			
	 T27	340		637,00
13000 005278	Cırcırlı Manyetik Bits Tutucu Tornavida (175mm) Ratcheting Screwdriver (175mm)		1	
4790 26 6360	Üniversal Bits Adaptörü (Manyetik) Screwdriver Universal Bit Holder (Magnetic)		1	

13000 005278

Cırcırlı Manyetik Bits Tutucu Tornavida
Ratcheting Screwdriver



KOD CODE	mm	L mm	g		TL/Ad.
13000 005278	6.3	175	130	5	378,25

4810-4860

Düz Bits Uçlar

Bits Flat

25mm-50mm-75mm-100mm-150mm



Krom vanadyum
Chrom vanadium

KOD CODE	⊖	L mm	g	TL/Ad.	
4810 20 0645	0.6x4.5	25	5	10	17,25
4810 20 0855	0.8x5.5	25	5	10	17,25
4810 20 1265	1.2x6.5	25	5	10	17,25
4810 20 5645	0.6x4.5	50	10	10	28,50
4810 20 5855	0.8x5.5	50	10	10	28,50
4810 20 5265	1.2x6.5	50	10	10	28,50
4860 20 0745	0.6x4.5	75	11	10	42,75
4860 20 0755	0.8x5.5	75	13	10	42,75
4860 20 0765	1.2x6.5	75	15	10	42,75
4860 20 1045	0.6x4.5	100	14	10	64,50
4860 20 1055	0.8x5.5	100	17	10	64,50
4860 20 1065	1.2x6.5	100	18	10	64,50
4860 20 1545	0.6x4.5	150	21	10	91,75
4860 20 1555	0.8x5.5	150	26	10	91,75
4860 20 1565	1.2x6.5	150	28	10	91,75

4810

Düz Bits Takımı (25 mm)

Flat Bit Set (25 mm)



KOD CODE	⊖	g	TL/Ad.	
4810 00 0645	06x4.5	45	10	172,50
4810 00 0855	0.8x5.5	50	10	172,50
4810 00 1265	1.2x6.5	55	10	172,50

4820-4870

Yıldız Bits Uçlar

Bits Phillips

25mm-50mm-75mm-100mm-150mm



Krom vanadyum
Chrom vanadium

KOD CODE	+	L mm	g	TL/Ad.	
4820 21 0001	Ph1	25	5	10	18,50
4820 21 0002	Ph2	25	5	10	18,50
4820 21 0003	Ph3	25	5	10	18,50
4820 21 0011	Ph1	50	10	10	33,25
4820 21 0012	Ph2	50	10	10	33,25
4820 21 0013	Ph3	50	10	10	33,25
4870 21 0701	Ph1	75	17	10	44,50
4870 21 0702	Ph2	75	18	10	44,50
4870 21 0703	Ph3	75	18	10	44,50
4870 21 1001	Ph1	100	20	10	68,25
4870 21 1002	Ph2	100	24	10	68,25
4870 21 1003	Ph3	100	24	10	68,25
4870 21 1501	Ph1	150	23	10	96,00
4870 21 1502	Ph2	150	33	10	96,00
4870 21 1503	Ph3	150	33	10	96,00

4820

Yıldız Bits Takımı (25 mm)

Phillips Bit Set (25 mm)



KOD CODE	+	g	TL/Ad.	
4820 00 0001	Ph1	50	10	185,00
4820 00 0002	Ph2	50	10	185,00
4820 00 0003	Ph3	55	10	185,00

4825-4880

Pozidriv Bits Uçlar

Bits Pozidriv

25mm-50mm-75mm-100mm-150mm



Krom vanadyum
Chrom vanadium

KOD CODE	+	L mm	g	□	TL/Ad.
4825 21 0001	Pz1	25	5	10	20,25
4825 21 0002	Pz2	25	5	10	20,25
4825 21 0003	Pz3	25	5	10	20,25
4825 21 0011	Pz1	50	10	10	35,25
4825 21 0012	Pz2	50	10	10	35,25
4825 21 0013	Pz3	50	10	10	35,25
4880 21 0701	Pz1	75	17	10	45,75
4880 21 0702	Pz2	75	18	10	45,75
4880 21 0703	Pz3	75	18	10	45,75
4880 21 1001	Pz1	100	20	10	69,00
4880 21 1002	Pz2	100	24	10	69,00
4880 21 1003	Pz3	100	24	10	69,00
4880 21 1501	Pz1	150	23	10	98,75
4880 21 1502	Pz2	150	33	10	98,75
4880 21 1503	Pz3	150	33	10	98,75

4830-4885

Torx® Bits Uçlar

Bits Torx®

25mm-50mm-75mm-100mm-150mm



Krom vanadyum
Chrom vanadium

KOD CODE	★	L mm	g	□	TL/Ad.
4830 21 0025	T25	25	5	10	27,50
4830 21 0027	T27	25	5	10	27,50
4830 21 0030	T30	25	5	10	27,50
4830 21 0040	T40	25	5	10	27,50
4830 21 0125	T25	50	10	10	35,25
4830 21 0127	T27	50	10	10	35,25
4830 21 0130	T30	50	10	10	35,25
4830 21 0140	T40	50	10	10	35,25
4885 21 0725	T25	75	12	10	48,50
4885 21 0727	T27	75	15	10	48,50
4885 21 0730	T30	75	15	10	48,50
4885 21 0740	T40	75	17	10	48,50
4885 21 1025	T25	100	15	10	70,00
4885 21 1027	T27	100	20	10	70,00
4885 21 1030	T30	100	20	10	70,00
4885 21 1040	T40	100	23	10	70,00
4885 21 1525	T25	150	20	10	100,25
4885 21 1527	T27	150	25	10	100,25
4885 21 1530	T30	150	25	10	100,25
4885 21 1540	T40	150	33	10	100,25

4825

Pozidriv Bits Takımı (25 mm)

Pozidriv Bit Set (25 mm)



KOD CODE	+	g	□	TL/Ad.
4825 00 0001	Pz1	50	10	202,50
4825 00 0002	Pz2	55	10	202,50
4825 00 0003	Pz3	55	10	202,50

4830

Torx® Bits Takımı (25 mm)

Torx® Bit Set (25 mm)



KOD CODE	★	g	□	TL/Ad.
4830 00 0025	T25	50	10	275,00
4830 00 0027	T27	50	10	275,00
4830 00 0030	T30	55	10	275,00
4830 00 0040	T40	60	10	275,00

4784 19 6346

1/4"Avuç İçi Bits Tutucu
Palm Ratchet Bit Holder

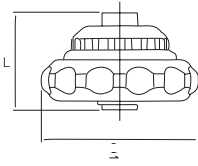

KOD CODE	Ø	L mm	g		TL/Ad.
4784 19 6346	46	26,5	100	5	575,00

4850 00 0713

75mm Uzun Bits Uç Takımı (13 Parça)
Bit Set, Long Type 75 mm (13 Pcs)



75mm

KOD CODE	İÇERİK CONTENTS	g		TL/Ad.
4850 00 0713	Düz Uçlar Flat Bits 0.6x4.5 - 0.8x 5.5 1.2x6.5	204	13	593,00
	Yıldız Uçlar Phillips Bits Ph1 - Ph2 - Ph3			
	Pozidriv Uçlar Pozidriv Bits Pz1 - Pz2 - Pz3			
	Torx® Uçlar Torx® Bits T25 - T27 T30 - T40			

4850 00 1013

100mm Uzun Bits Uç Takımı (13 Parça)
Bit Set, Long Type 100 mm (13 Pcs)



100mm

KOD CODE	İÇERİK CONTENTS	g		TL/Ad.
4850 00 1013	Düz Uçlar Flat Bits 0.6x4.5 - 0.8x 5.5 1.2x6.5	263	13	885,25
	Yıldız Uçlar Phillips Bits Ph1 - Ph2 - Ph3			
	Pozidriv Uçlar Pozidriv Bits Pz1 - Pz2 - Pz3			
	Torx® Uçlar Torx® Bits T25 - T27 -T30 - T40			

4850 00 1513

150mm Uzun Bits Uç Takımı (13 Parça)
Bit Set, Long Type 150 mm (13 Pcs)



150mm

KOD CODE	İÇERİK CONTENTS	g		TL/Ad.
4850 00 1513	Düz Uçlar Flat Bits 0.6x4.5 - 0.8x 5.5 1.2x6.5	356	13	1260,50
	Yıldız Uçlar Phillips Bits Ph1 - Ph2 - Ph3			
	Pozidriv Uçlar Pozidriv Bits Pz1 - Pz2 - Pz3			
	Torx® Uçlar Torx® Bits T25 - T27 - T30 - T40			

4900

Allen Anahtar Altı Köşe Standart Boy (mm) Hex Key Wrench Standard Size (mm)



TS ISO 2936
DIN ISO 2936

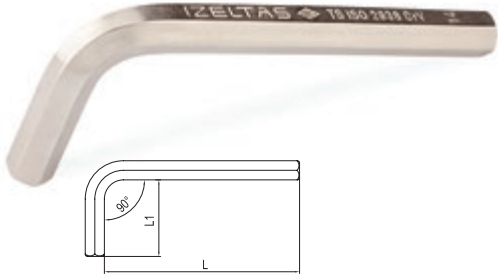

Krom Vanadyum, Nikel Kaplı
Chrom Vanadium, Nickel Plated

KOD CODE	mm	L mm	L1 mm	g	TL/Ad.	
4900 22 0015	1.5	45	14	1.5	10	10,25
4900 22 0020	2	50	16	2	10	14,75
4900 22 0025	2.5	56	18	4	10	18,25
4900 22 0030	3	63	20	6	10	19,50
4900 22 0035	3.5	66	22	8	10	24,75
4900 22 0040	4	70	25	10	10	25,25
4900 22 0050	5	80	28	20	10	29,00
4900 22 0060	6	90	32	30	10	38,00
4900 22 0070	7	95	34	40	10	56,00
4900 22 0080	8	100	36	55	10	64,50
4900 22 0090	9	105	38	75	10	79,25
4900 22 0100	10	112	40	100	10	97,75
4900 22 0120	12	125	45	160	10	141,50
4900 22 0140	14	140	56	250	5	226,00
4900 22 0160	16	152	60	375	5	416,00
4900 22 0170	17	160	63	425	5	449,00
4900 22 0190	19	180	70	610	5	554,75
4900 22 0220	22	200	80	940	5	926,25
4900 22 0240	24	224	90	1250	5	1.250,00

4900

Allen Anahtar Takım Altı Köşe Standart Boy (mm) Hex Key Wrench Set Standard Size (mm)



KOD CODE	İÇERİK CONTENTS	g	TL/Ad.	
4900 00 3110	2 - 2.5 - 3 - 4 - 5 - 6 7 - 8 - 9 - 10	400	10	442,25
4900 00 3112	2 - 2.5 - 3 - 3.5 - 4 - 5 6 - 7 - 8 - 9 - 10 - 12	565	12	608,50

4901

Allen Anahtar Altı Köşe (SAE) Hex Key Wrench (SAE)

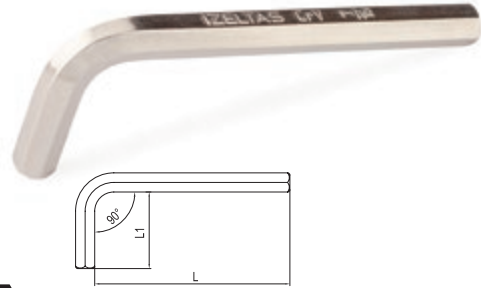

Krom Vanadyum, Nikel Kaplı
Chrom Vanadium, Nickel Plated

KOD CODE	inch	L mm	L1 mm	g	TL/Ad.	
4901 22 1984	5/64"	50	16	2	10	19,50
4901 22 2381	3/32"	54	18	4	10	21,25
4901 22 3125	1/8"	58	20	5	10	25,50
4901 22 3968	5/32"	62	22	10	10	31,00
4901 22 4762	3/16"	68	24	15	10	32,00
4901 22 5556	7/32"	74	26	25	10	42,50
4901 22 6350	1/4"	82	28	35	10	52,00
4901 22 7937	5/16"	94	32	55	10	64,50
4901 22 9825	3/8"	106	38	90	10	88,75
4901 22 1111	7/16"	118	42	130	10	119,00
4901 22 1270	1/2"	132	46	190	10	150,00
4901 22 1428	9/16"	144	52	265	10	218,25
4901 22 1587	5/8"	156	58	365	10	339,25
4901 22 1905	3/4"	176	66	600	5	474,50

4901

Allen Anahtar Takım Altı Köşe (SAE) Hex Key Wrench Set (SAE)



KOD CODE	İÇERİK CONTENTS	g	TL/Ad.	
4901 00 3110	5/64" - 3/32" - 1/8" - 5/32" 3/16" - 7/32" - 1/4" - 5/16" 3/8" - 7/16"	405	10	496,00
4901 00 3112	5/64" - 3/32" - 1/8" - 5/32" 3/16" - 7/32" - 1/4" - 5/16" 3/8" - 7/16" - 1/2" - 9/16"	855	12	864,25

4903

Allen Anahtar Altı Köşe Uzun Boy (mm)
Hex Key Wrench Long Pattern (mm)



TS ISO 2936
DIN ISO 2936



Krom Vanadyum, Nikel Kaplı
Chrom Vanadium, Nickel Plated

KOD CODE	mm	L mm	L1 mm	g		TL/Ad.
4903 22 0020	2	100	16	3	10	21,25
4903 22 0025	2.5	112	18	5	10	24,75
4903 22 0030	3	126	20	10	10	28,25
4903 22 0035	3.5	136.5	22	15	10	34,50
4903 22 0040	4	140	25	20	10	35,50
4903 22 0050	5	160	28	30	10	39,50
4903 22 0060	6	180	32	50	10	64,50
4903 22 0070	7	190	34	80	10	95,25
4903 22 0080	8	200	36	100	10	103,75
4903 22 0090	9	210	38	145	10	140,50
4903 22 0100	10	224	40	180	10	174,00
4903 22 0120	12	250	45	285	10	249,75
4903 22 0140	14	280	56	460	5	402,25
4903 22 0160	16	290	60	625	5	650,25
4903 22 0170	17	320	63	750	5	708,25
4903 22 0190	19	360	70	1100	5	1.049,25

4903

Allen Anahtar Takım Altı Köşe Uzun Boy (mm)
Hex Key Wrench Set Long Pattern (mm)



KOD CODE	İÇERİK CONTENTS	g		TL/Ad.
4903 00 3110	2 - 2.5 - 3 - 4 - 5 - 6 7 - 8 - 9 - 10	660	10	727,25
4903 00 3112	2 - 2.5 - 3 - 3.5 - 4 - 5 6 - 7 - 8 - 9 - 10 - 12	940	12	1.011,50

4905

Yuvarlak Başlı Allen Anahtar Standart Boy (mm)
Hex Key Wrench Ballpoint (mm)

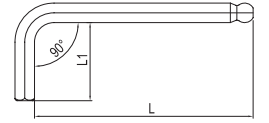

Krom Vanadyum, Nikel Kaplı
Chrom Vanadium, Nickel Plated

KOD CODE	mm	L mm	L1 mm	g		TL/Ad.
4905 22 0020	2	50	16	3	10	23,75
4905 22 0025	2.5	56	18	4	10	28,50
4905 22 0030	3	63	20	5	10	32,50
4905 22 0040	4	70	25	10	10	40,00
4905 22 0050	5	80	28	20	10	42,25
4905 22 0060	6	90	32	30	10	68,00
4905 22 0080	8	100	36	55	10	104,00
4905 22 0100	10	112	40	100	10	165,25

4905 00 7108

Yuvarlak Başlı Allen Anahtar Takımı Standart Boy (8 Parça, mm)
Hex Key Wrench Ballpoint Set (8 Pcs, mm)



KOD CODE	İÇERİK CONTENTS	g		TL/Ad.
4905 00 7108	2 - 2.5 - 3 - 4 5 - 6 - 8 - 10	275	8	504,25

4906

Yuvarlak Başlı Allen Anahtar Uzun Boy (mm)
Hex Key Wrench Ballpoint Long Pattern (mm)

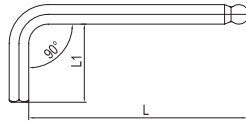

Krom Vanadyum, Nikel Kaplı
Chrom Vanadium, Nickel Plated

KOD CODE	mm	L mm	L1 mm	g	TL/Ad.	
4906 22 0015	1.5	79	12	1.5	10	31,75
4906 22 0020	2	84	16	3	10	42,25
4906 22 0025	2.5	89	16	5	10	45,75
4906 22 0030	3	99	18	7	10	49,00
4906 22 0040	4	109	23	13	10	56,00
4906 22 0050	5	125	26	25	10	70,25
4906 22 0060	6	150	28	42	10	80,75
4906 22 0080	8	167	33	85	10	128,00
4906 22 0100	10	190	37	150	10	190,25

4910

Torx® Allen Anahtar
Torx® Key Wrench

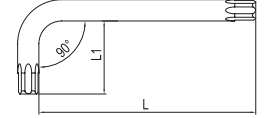

Krom Vanadyum, Nikel Kaplı
Chrom Vanadium, Nickel Plated

KOD CODE	☆	L mm	L1 mm	g	TL/Ad.	
4910 22 0006	T6	42	16	2	10	98,00
4910 22 0007	T7	48	16	2	10	98,00
4910 22 0008	T8	48	16	3	10	98,00
4910 22 0009	T9	48	16	3	10	98,75
4910 22 0010	T10	51	17	4	10	98,75
4910 22 0015	T15	54	18	5	10	101,50
4910 22 0020	T20	57	19	5	10	106,75
4910 22 0025	T25	60	20	10	10	106,75
4910 22 0027	T27	64	21	15	10	106,75
4910 22 0030	T30	70	24	20	10	114,00
4910 22 0040	T40	76	26	30	10	121,50
4910 22 0045	T45	83	29	40	10	148,75
4910 22 0050	T50	95	32	60	10	169,25
4910 22 0055	T55	108	35	125	10	234,75
4910 22 0060	T60	120	38	185	10	323,25

4906 00 3109

Yuvarlak Başlı Allen Anahtar Takım Altı Köşe Uzun Boy (9 parça, mm)
Hex Key Wrench Ballpoint Long Pattern Set (9 Pcs, mm)



KOD CODE	İÇERİK CONTENTS	g	TL/Ad.	
4906 00 3109	1.5 - 2 - 2.5 - 3 - 4 - 5 - 6 8 - 10	355	9	694,00

4910 00 7108

Torx® Allen Anahtar Takımı (8 Parça)
Torx® Key Wrench Set (8 Pcs)



KOD CODE	İÇERİK CONTENTS	g	TL/Ad.	
4910 00 7108	T9 - T10 - T15 T20 - T25 - T27 T30 - T40	155	8	854,75

4912 00 3107

Kaset Allen Anahtar Takımı (7 Parça, mm)
Hex Key Wrench Folding Set (7 Pcs, mm)



Krom vanadyum
Chrom vanadium

KOD CODE	İÇERİK CONTENTS	g	TL/ Ad.
4912 00 3107	2.5 - 3 - 4 - 5 - 6 - 8 - 10	355	1 863,00

4912 00 0007

Kaset Allen Anahtar Takımı (7 Parça, mm)
Hex Key Wrench Folding Set (7 Pcs, mm)



Krom vanadyum
Chrom vanadium

KOD CODE	İÇERİK CONTENTS	g	TL/ Ad.
4912 00 0007	1.5 - 2 - 2.5 3 - 4 - 5 - 6	130	1 546,75

4909

T Tipi Torx® Allen Anahtar
T Handle Torx® Key Wrench

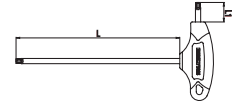

Krom vanadyum, Nikel kaplı
Chrom vanadium, Nickel plated

KOD CODE	★	L1 mm	L2 mm	g	TL/ Ad.
4909 22 0009	T9	111.5	21	15	5 249,75
4909 22 0010	T10	111.5	21	15	5 254,75
4909 22 0015	T15	105	16	20	5 260,00
4909 22 0020	T20	105	16	25	5 262,25
4909 22 0025	T25	129	25	50	5 268,00
4909 22 0027	T27	129	25	50	5 298,00
4909 22 0030	T30	122	20	105	5 306,25
4909 22 0040	T40	153	35	100	5 317,75

4909 00 8108

T Tipi Torx Allen Anahtar Takımı (8 Parça)
T Handle Torx Key Wrench Set (8 Pcs)

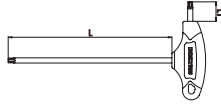

KOD CODE	İÇERİK CONTENTS	g	TL/ Ad.
4909 00 8108	T9 - T10 - T15 - T20 T25 - T27 - T30 - T40	407	8 2.216,75

4920
T Tipi Allen Anahtar (mm)
 Hex Key Wrench T - Handle (mm)

 Krom Vanadyum
 Chrom Vanadium

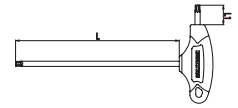
KOD CODE	mm	L mm	L1 mm	g		TL/Ad.
4920 22 0025	2.5	102	17.5	10	5	135,00
4920 22 0030	3	118	21	15	5	137,50
4920 22 0040	4	131	24.5	35	5	154,50
4920 22 0050	5	141	22	50	5	164,75
4920 22 0060	6	154	26	85	5	188,00
4920 22 0070	7	174	36	120	5	197,50
4920 22 0080	8	184	34	165	5	232,00
4920 22 0100	10	209	45.5	260	5	351,00

4921
T Tipi Yuvarlak Başlı Allen Anahtar (mm)
 Hex Key Wrench T - Handle Ballpoint (mm)

 Krom Vanadyum
 Chrom Vanadium

KOD CODE	mm	L mm	L1 mm	g		TL/Ad.
4921 22 0025	2.5	102	17.5	10	5	175,25
4921 22 0030	3	118	21	15	5	177,75
4921 22 0040	4	131	24.5	35	5	199,00
4921 22 0050	5	141	22	50	5	213,50
4921 22 0060	6	154	26	85	5	244,50
4921 22 0070	7	174	36	120	5	256,00
4921 22 0080	8	184	34	165	5	275,00
4921 22 0100	10	209	45.5	260	5	456,00

4920 00 8108
T Tipi Allen Anahtar Takımı (8 Parça, mm)
 Hex Key Wrench T - Handle Set (8 Pcs, mm)

KOD CODE	İÇERİK CONTENTS	g		TL/Ad.
4920 00 8108	2.5 - 3 - 4 - 5 6 - 7 - 8 - 10	760	8	1.560,25

4921 00 8108
T Tipi Yuvarlak Başlı Allen Anahtar Takımı (8 Parça, mm)
 Hex Key Wrench T - Handle Ballpoint Set (8 Pcs, mm)

KOD CODE	İÇERİK CONTENTS	g		TL/Ad.
4921 00 8108	2.5 - 3 - 4 5 - 6 - 7 - 8 - 10	755	8	1.997,00



IZELTAS®

KESKİLER VE ÇEKİÇLER

CHISELS AND HAMMERS

Keskiler

Chisels

Zimbalar

Punches

Çekiçler

Hammers

Keserler

Adzes



T



5010

Iskarpela (Düz)
Wood Chisel

TS 531

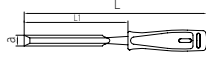

Özel alaşımli çelik, Uç indüksiyonda sertleştirilmiş, PP Saplı
Special steel, Induction hardened tips, PP Handle

KOD CODE	a mm	L mm	L1 mm	g	TL/Ad.	
5010 23 0006	6	240	120	115	5	249,25
5010 23 0008	8	242	122	125	5	266,25
5010 23 0010	10	244	124	135	5	281,00
5010 23 0012	12	246	126	135	5	308,25
5010 23 0014	14	248	128	145	5	318,75
5010 23 0016	16	250	130	150	5	341,00
5010 23 0018	18	252	132	160	5	369,75
5010 23 0020	20	254	134	170	5	411,25
5010 23 0022	22	256	136	190	5	445,50
5010 23 0024	24	258	138	195	5	481,50
5010 23 0026	26	260	140	200	5	498,75
5010 23 0030	30	264	144	205	5	532,50

5010 00 8106

Iskarpela Takım (6 parça)
Wood Chisel Set (6 Pcs)



KOD CODE	İÇERİK CONTENTS	g	TL/Ad.	
5010 00 8106	10 - 12 - 14 16 - 18 - 20	985	6	2.030,00

5500

Düz Keski
Flat Cold Chisel

TSE
TS 492
DIN 6453



Özel alaşımli çelik, Krom kaplı
Special steel, Chrom plated

KOD CODE	L mm	a mm	g	TL/Ad.	
5500 23 0100	100	17	75	5	149,25
5500 23 0125	125	19	110	5	179,75
5500 23 0150	150	21	180	5	230,75
5500 23 0175	175	24	245	5	260,00
5500 23 0200	200	27	340	5	362,25
5500 23 0250	250	30	525	5	445,00
5500 23 0300	300	30	635	5	712,75

5500

Düz Keski (Kalkan İzoleli)
Flat Cold Chisel (With Safety Handle)

TSE
TS 492
DIN 6453

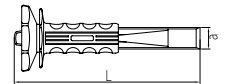

Özel alaşımli çelik, Krom kaplı
Special steel, Chrom plated

KOD CODE	L mm	a mm	g	TL/Ad.	
5500 23 1250	250	30	700	1	566,25
5500 23 1300	300	30	790	1	825,00

5510
Tesviyeci Düz Keski
 Flat Cold Chisel Octagonal

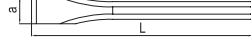
 TS 492
 DIN 6453

 Krom vanadyum
 Chrom vanadium

KOD CODE	L mm	a mm	g	TL/Ad.
5510 23 0125	125	10	75	10 204,50
5510 23 0150	150	14	125	10 255,25

5520
Tırnak Keski
 Cross Cut Chisel

 Krom vanadyum
 Chrom vanadium

KOD CODE	L mm	a mm	g	TL/Ad.
5520 23 0125	130	5	70	10 229,50
5520 23 0150	150	6	110	10 273,25

5540
Nokta Zimba
 Center Punch

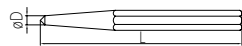
 TS 2338-3
 DIN 7250

 Krom vanadyum
 Chrom vanadium

KOD CODE	L mm	L inch	σD mm	g	TL/Ad.
5540 24 4120	120	4 3/4"	4	65	10 172,75
5540 24 5120	120	4 3/4"	5	95	10 203,50
5540 24 5150	150	6"	5	115	10 225,25
★ 5540 24 0412	120	4 3/4"	4	65	10 170,75

★ Stoklarla Sınırlıdır / It is Limited by Stocks.

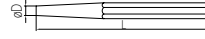
5545
Konik Pim Zimba
 Drift Punch

 TS 2338-2
 DIN 6458

 Krom vanadyum
 Chrom vanadium

KOD CODE	L mm	L inch	σD mm	g	TL/Ad.
5545 24 0002	120	4 3/4"	2	90	10 148,75
5545 24 0003	120	4 3/4"	3	90	10 161,75
5545 24 0004	120	4 3/4"	4	90	10 182,25
5545 24 0005	120	4 3/4"	5	95	10 185,75
5545 24 0006	120	4 3/4"	6	95	10 273,50
5545 24 0007	120	4 3/4"	7	100	10 285,00
5545 24 0008	150	6"	8	125	10 295,75
5545 24 0009	150	6"	9	130	10 302,75
5545 24 0010	150	6"	10	130	10 309,00
★ 5545 24 0012	150	6"	12	180	10 323,00
★ 5545 24 0103	120	4 3/4"	3	90	10 169,25

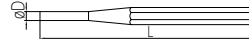
5550
Düz Pim Zimba
 Split Pin Punch

 TS 2338-1
 DIN 6450

 Krom vanadyum
 Chrom vanadium

KOD CODE	L mm	L inch	σD mm	g	TL/Ad.
5550 24 0002	150	6"	2	70	5 213,25
5550 24 0003	150	6"	3	65	5 213,25
5550 24 0004	150	6"	4	65	5 216,50
5550 24 0005	150	6"	5	65	5 216,50
5550 24 0006	150	6"	6	70	5 218,25
5550 24 0007	150	6"	7	100	5 227,50
5550 24 0008	150	6"	8	105	5 243,25
5550 24 0009	150	6"	9	110	5 246,75
5550 24 0010	150	6"	10	120	5 249,25
★ 5550 24 0105	150	6"	5	65	5 190,25

5550 00 1006
Düz Pim Zimba Takımı (6 Parça)
 Split Pin Punch (6 Pcs)

KOD CODE	İÇERİK CONTENTS	g	TL/Ad.
5550 00 1006	3 - 4 - 5 - 6 - 7 - 8	865	6 1.335,25

5600 00 6106

Keski Zimba Seti (6 Parça) Chisel And Punch Set (6 Pcs)



KOD CODE	İÇERİK CONTENTS	g	TL/Ad.
5510 23 0125	125 Tevsiyeci Düz Keski 125 Flat Cold Chisel Octagonal	865	1.240,25
5510 23 0150	150 Tevsiyeci Düz Keski 150 Flat Cold Chisel Octagonal		
5520 23 0125	130 Tırnak Keski 130 Cross Cut Chisel		
5540 24 4120	4x120 Nokta Zimba 4x120 Center Punch		
5550 24 0005	5x150 Düz Pim Zimba 5x150 Split PinPunch		
5545 24 0003	3x120 Konik Pim Zimba 3x120 Drift Punch		



5700

Kayış Zimba Belt Punch

DIN 7200
TSEK



Krom vanadyum, Elektrostatik boyanmış
Chrom vanadium, Electrostatically painted

KOD CODE	ØD mm	L mm	g	TL/Ad.
5700 24 0003	3	105	35	127,75
5700 24 0004	4	105	40	133,50
5700 24 0005	5	110	50	145,00
5700 24 0006	6	110	60	147,75
5700 24 0007	7	115	75	162,75
5700 24 0008	8	115	90	172,75
5700 24 0009	9	120	100	192,75
5700 24 0010	10	120	110	205,50
5700 24 0011	11	125	130	220,75
5700 24 0012	12	125	165	264,25
5700 24 0013	13	130	165	278,00
5700 24 0014	14	130	180	305,50
5700 24 0015	15	135	245	350,00
5700 24 0016	16	135	300	383,50
5700 24 0017	17	140	365	419,25
5700 24 0018	18	140	380	457,00
5700 24 0019	19	145	405	496,75
5700 24 0020	20	145	450	529,00

5700

Kayış Zimba Takımı Belt Punch Set

TSEK



KOD CODE	İÇERİK CONTENTS	g	TL/Ad.
5700 00 2110	3 - 4 - 5 - 6 - 7 8 - 9 - 10 - 11 - 12	845	10 1.772,75
5700 00 2112	3 - 4 - 5 - 6 - 7 - 8 - 9 10 - 11 - 12 - 13 - 14	1180	12 2.356,25

5800
Tesviyeci Çekiç
Machinist Hammer

 TS 5-1
 DIN 1041

IZELTAS YOUTUBE

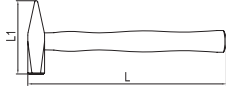
Yedek parça sayfa 243
Spare parts page 243

Özel alaşımli çelik, İndüksiyonda sertleştirilmiş, Elektrostatik boyanmış
Special steel, Induction hardened, Electrostatically painted

KOD CODE	L mm	L1 mm	g	g	TL/Ad.
5800 25 0100	260	82	100	160	10 277,00
5800 25 0200	280	95	200	260	10 302,00
5800 25 0300	300	105	300	395	10 365,75
5800 25 0500	320	118	500	600	5 423,00
5800 25 1000	360	135	1000	1095	5 611,50
5800 25 1500	380	145	1500	1630	5 802,75
5800 25 2000	400	155	2000	2100	5 987,00

5810
Emniyet Çekici
Safety Hammer

TS 5-1

Özel alaşımli çelik, İndüksiyonda sertleştirilmiş, Elektrostatik boyanmış
Special steel, Induction hardened, Electrostatically painted

KOD CODE	L mm	L1 mm	g	g	TL/Ad.
5810 25 1000	360	135	1000	1095	5 797,25
5810 25 1500	380	145	1500	1630	5 1.103,00
5810 25 2000	400	155	2000	2100	5 1.362,25

Emniyet çekici

Çekiç kafası ile sapın birleşiminde yuvarlak kama ve yapışkan malzeme kullanılarak sağlamlığı artırılmış ayrıca birleşimi çelik sac malzeme ile desteklenerek güvenli kullanım sağlanmıştır.

Safety Hammer

Connection between the hammer head and the handle is ensured by circular wedge and epoxy glue, while it is also reinforced by sheet metal for safe use.

5850
Plastik Çekiç
Plastic Hammer

TS 5-2

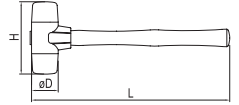
Yedek parça sayfa 243
Spare parts page 243
Darbeye dayanıklı, Kolay değiştirilebilir başlık
Durable and easily changeable heads

KOD CODE	L mm	σD mm	H mm	g	TL/Ad.
5850 25 0030	300	30	100	345	5 396,00
5850 25 0040	320	40	110	645	5 481,75
5850 25 0050	350	50	120	1015	5 610,75

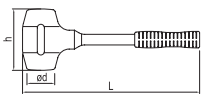
5870 25 0400
Lastik Çekiç
Rubber Hammer

KOD CODE	L mm	σd mm	h mm	g	g	TL/Ad.
5870 25 0400	300	47	104	400	540	5 766,75

5865

Madırğa
Mallet

TS 5-1

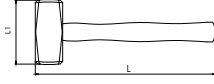

Yedek parça sayfa 243
Spare parts page 243

Özel alaşımli çelik
Special steel

KOD CODE	L mm	L1 mm				TL/Ad.
5865 25 1000	260	95	1000	1210	5	731,00
5865 25 1500	280	110	1500	1770	5	872,25

6410 25 0800

Nacak
Hatchet

TS 748-4

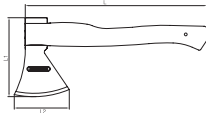

Yedek parça sayfa 243
Spare parts page 243

Özel alaşımli çelik, İndüksiyonda sertleştirilmiş, Elektrostatik boyanmış
Special steel, Induction hardened, Electrostatically painted

KOD CODE	L mm	L1 mm	L2 mm				TL/Ad.
6410 25 0800	380	165	115	800	1065	1	1.458,25

13000 005248

Kamp Baltası
Hatchet

**YENİ
NEW**

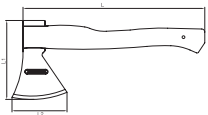

Özel alaşımli çelik, Elektrostatik boyanmış
Special steel, Electrostatically painted

KOD CODE	L mm	L1 mm	L2 mm			TL/Ad.
13000 005248	270	118	85	600	1	1.206,00

6400 25 0600

Keser
Adze

TS 686-2

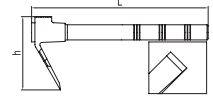

Yedek parça sayfa 243
Spare parts page 243

Özel alaşımli çelik, İndüksiyonda sertleştirilmiş,
Elektrostatik boyanmış, PVC ağız koruyucu
Special steel, Induction hardened, Electrostatically painted,
PVC cutting edge protector

KOD CODE	L mm	h mm				TL/Ad.
6400 25 0600	400	125	400	550	5	805,25

6401 25 0600

Usta Keseri
Master Adze

TS 686-2

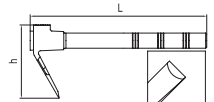

Yedek parça sayfa 243
Spare parts page 243

Özel alaşımli çelik, İndüksiyonda sertleştirilmiş,
Elektrostatik boyanmış, PVC ağız koruyucu
Special steel, Induction hardened, Electrostatically painted,
PVC cutting edge protector

KOD CODE	L mm	h mm				TL/Ad.
6401 25 0600	400	125	400	540	5	805,25



ZELTAS
DN 9131

PROJEKTION HÄHNCHEN
800 GR.

6410



ZELTAS

GENEL EL ALETLERİ

GENERAL HAND TOOLS

Servis Aletleri
Service Equipment

Perçin Tabancası
Riveting Pliers

İşkenceler
Clamps

İnşaat Ekipmanları
Construction Equipment

Metreler
Measuring Tapes

Mengene
Forged Steel Vice

Su Terazisi
Straight Level

Gres Pompası
Grease Gun



KABLO SIYIRICI (KANCA BIÇAKLI) / CABLE STRIPPER (WITH HOOKED BLADE)

Tüm standart kabloları sıyırmak için daha uzun ömür, daha hızlı kesme ve daha az aşınma sağlayan özel titanyum nitrür (TIN) kaplama
Tin plated long lasting/fast cutting blade to strip all standard cables

Özel alışımlı çelikten sertleştirilmiş ve kaplanmış kanca bıçak
Plated special alloy hardened steel hook blade

Kapasite 8-28mm çaplı kablolar için uygun
Suitable for 8-28mm diameter cables

Özel kaydırmaz formu dayanıklı polyamid (PA) sap
Non-slip and durable polyamid handle

Çevirerek kolay bıçak yükseklik ayarı
Easy-to-rotate blade height adjuster

03750 50 020

Kablo Sıyrıcı (Kanca Bıçaklı)
Cable Stripper (With Hooked Blade)



 Yedek parça sayfa 243
Spare parts page 243

KOD CODE	ÖLÇÜ SIZE	g		TL/ Ad.
03750 50 020	Ø8-28	79	5	554,00

03752 50 625

Kablo Sıyrıcı
Cable Stripper



 Yedek parça sayfa 243
Spare parts page 243

KOD CODE	ÖLÇÜ SIZE	g		TL/ Ad.
03752 50 625	Ø4-16	70	5	504,25

03751 50 012

Koaksiyel Kablo Sıyrıcı
Coaxial Cable Stripper



İZELTAS YOUTUBE

KOD CODE	ÖLÇÜ SIZE	g		TL/ Ad.
03751 50 012	Dış (1) İç (2)	20	5	718,75

03753 50 054

Mekanik Kablo Sıyrıcı
Mechanical Cable Stripper



KOD CODE	ÖLÇÜ SIZE	g		TL/ Ad.
03753 50 054	0.2/6	100	5	947,00

03753 50 026

1000 V Mekanik Kablo Sıyrıcı
Mechanical Cable Stripper 1000 V



KOD CODE	ÖLÇÜ SIZE	g		TL/ Ad.
03753 50 026	0.2/6	105	5	1.182,75

05881

Krom Şerit Metre
Chrom Steel Case, Measuring tapes



KOD CODE	ÖLÇÜ SIZE M	g		TL/Ad.
05881 50 013	3	160	5	266,75
05881 50 015	5	220	5	301,00

05881

Plastik Şerit Metre
Plastic Steel Case, Measuring tapes



KOD CODE	ÖLÇÜ SIZE M	g		TL/Ad.
05881 50 003	3	145	5	224,25
05881 50 005	5	200	5	269,00

05886

Arazi Tipi Fiberglas Şerit Metre (Saplı)
Fiberglass Measuring Tape Field Type (With Holder)



KOD CODE	ÖLÇÜ SIZE M	g		TL/Ad.
05886 50 020	20	520	1	539,75
05886 50 030	30	585	1	576,75
05886 50 050	50	820	1	926,25

05880

Su Terazisi
Straight Level



Alüminyum gövde
Aluminyum body

KOD CODE	L mm	g		TL/Ad.
05880 50 040	400	250	5	806,00
05880 50 050	500	300	5	873,75
05880 50 060	600	350	5	949,75
05880 50 070	700	400	5	1.020,00
05880 50 080	800	450	5	1.102,00
05880 50 100	1000	500	5	1.254,50
05880 50 120	1200	550	5	1.484,00
05880 50 150	1500	600	5	1.710,25
05880 50 200	2000	800	5	2.389,25

05887 50 150

Kumpas
Vernier



Sürgülü, Stoplu
Sliding and with stop

KOD CODE	L mm	g		TL/Ad.
05887 50 150	150	155	5	1.944,50

05890 50 830

Testere Kolu
Hacksaw Frame



Yedek parça sayfa 244
Spare parts page 244

KOD CODE	L mm	g		TL/Ad.
05890 50 830	300	540	5	842,50

6735 27 0300

Dal Budama Testeresi
Pruning Saw



Yedek parça sayfa 244
Spare parts page 244

KOD CODE	L mm	g		TL/Ad.
6735 27 0300	300	400	5	844,25

14000 004238

Katlanabilir Budama Testeresi
Foldable Pruning Saw

YENİ
NEW



KOD CODE	L mm	g		TL/Ad.
14000 004238	120	155	5	706,00

05901 50 020

Sentil (20 Parça, mm)
Feeler Gauges (20 Pcs, mm)



KOD CODE	ÖLÇÜ SIZE mm	g		TL/Ad.
05901 50 020	0.05 - 1	90	10	178,00

6195 26 0260

Perçin Tabancası
Riveting Pliers



KOD CODE	ÖLÇÜ SIZE	CAPACITY mm	g		TL/Ad.
6195 26 0260	260	2 - 2.5 - 3 - 3.2	625	1	888,75

05902 50 020

Sentil (20 Parça, SAE)
Feeler Gauges (20 Pcs, SAE)



KOD CODE	ÖLÇÜ SIZE inch	g		TL/Ad.
05902 50 020	2 - 35/1000"	65	10	278,00

6220

Spiralli Mıknatıs
Flexible Magnet Holder

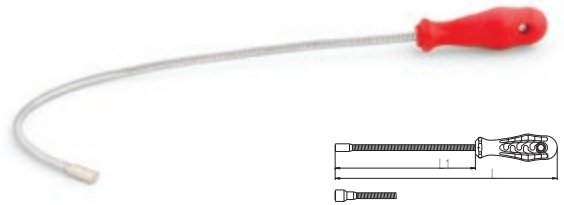

KOD CODE	KAPASİTE g	L mm	L1 mm	g		TL/Ad.
6220 26 0500	500	465	375	100	10	559,25
6220 26 1000	1000	465	375	105	10	592,50

6225

Madeni Yağdanlık (Flexible Uçlu)
Oiler With Flexible Spout



KOD CODE	ÖLÇÜ SIZE cc	g		TL/Ad.
6225 26 0200	200	170	5	297,00
6225 26 0300	300	200	5	334,00
6225 26 0500	500	225	5	366,50

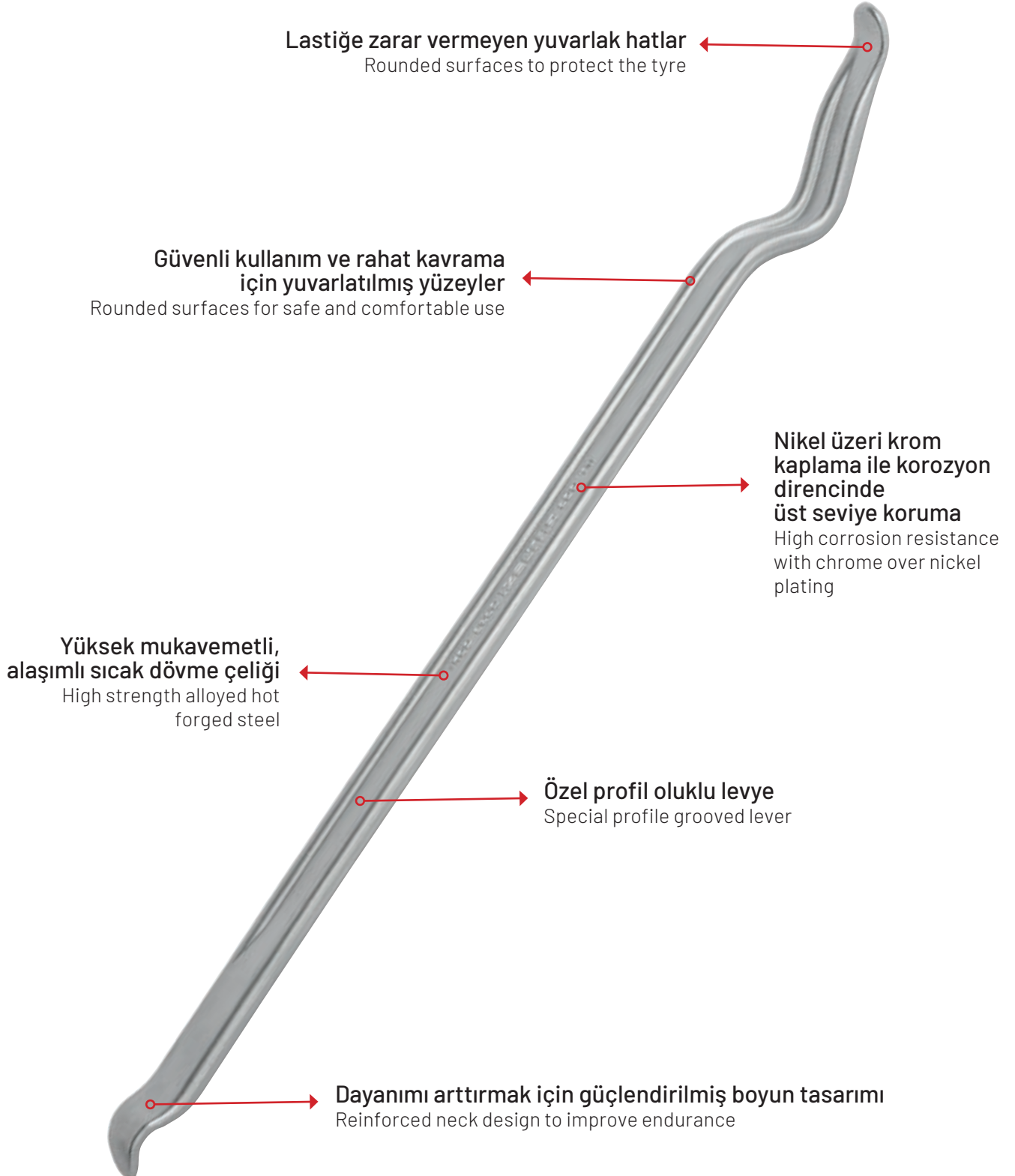

6230

Gres Pompası
Grease Gun



 Yedek parça sayfa 244
Spare parts page 244

KOD CODE	ÖLÇÜ SIZE cc	g		TL/Ad.
6230 26 0300	300	1200	1	719,75
6230 26 0500	500	1320	1	886,25

6240 26 0810

Tapa Anahtarı (iki ağız)
Offset Wrench For Carter Case



Krom vanadyum, Krom kaplı
Chrom vanadium, Chrom plated

KOD CODE	ÖLÇÜ mm	g		TL/Ad.
6240 26 0810	8x10	250	10	281,50

6350

Levye Oluklu
Tyre Lever, Straight

TSEK



Krom vanadyum, Krom kaplı
Chrom vanadium, Chrom plated

KOD CODE	L mm	L inch	g		TL/Ad.
6350 26 0300	300	12"	265	5	267,00
6350 26 0400	400	16"	440	5	336,75
6350 26 0500	500	20"	675	5	467,75
6350 26 0600	600	24"	900	5	571,50

6360 26 0600

Levye Oluklu Kıvrık Uçlu
Tyre Lever, Bent

TSEK



Krom vanadyum, Krom kaplı
Chrom vanadium, Chrom plated

KOD CODE	L mm	L inch	g		TL/Ad.
6360 26 0600	600	24"	910	5	631,50

6370 26 0100

Yağ Filtresi Sökeceği
Band Type Oil Filter Wrench



KOD CODE	σ mm	g		TL/Ad.
6370 26 0100	75 - 100	335	5	417,00



6375 26 6512**Çift Yönlü Üç Ayaklı Yağ Filtresi Sökeceği**
Left and Right Hand Operation, Triple Leg Oil Filter Wrench**3/8" - 1/2"**

KOD CODE	Ø mm	g	□	TL/Ad.
6375 26 6512	75-120	605	5	1.458,25

06374 50 140**Zincirli Yağ Filtresi Sökeceği**
Chain Wrench

KOD CODE	Ø mm	g	□	TL/Ad.
06374 50 140	60x140	390	5	880,75

6380 26 6016**Çift Zincirli Yağ Filtresi Sökeceği**
Oil Filter Wrench With Double Chain

KOD CODE	Ø mm	g	□	TL/Ad.
6380 26 6016	60-160	380	5	3.948,50

06373 50 140**Kayıslı Yağ Filtresi Sökeceği**
Strap Wrench

KOD CODE	Ø mm	g	□	TL/Ad.
06373 50 140	60x140	245	5	1.022,00

06375 50 100**Ayarlı Yağ Filtresi Sökeceği**
Adjustable Slot Type Oil Filter Wrench **Yedek parça sayfa 243**
Spare parts page 243

KOD CODE	Ø mm	g	□	TL/Ad.
06375 50 100	65-110	215	5	488,25

06390

Segman Çemberi
Piston Ring Compressor



KOD CODE	Ø mm	g	TL/Ad.
06390 50 125	125	235	5 871,25
06390 50 175	175	505	5 1.662,50

07415

Sıralı Tel Fırça (Ağaç Saplı)
Hand Brush (Wooden Handle)



KOD CODE	ÖLÇÜ SIZE	g	TL/Ad.
07415 50 003	3 SIRA 3 RAWS	125	5 64,75
07415 50 004	4 SIRA 4 RAWS	135	5 68,25
07415 50 005	5 SIRA 5 RAWS	145	5 76,25
07415 50 006	6 SIRA 6 RAWS	170	5 81,75

07416 50 001

Kıvrık Uçlu Fırça (Plastik Saplı)
Hand Brush (PP Handle)



KOD CODE	L mm	g	TL/Ad.
07416 50 001	270	110	5 101,25

07410 50 010

Makaralı Uzatma Kablosu (El Tipi)
Extension Cord Reel (With Handle)



Kablo / Cable ø 3x1.5 mm

KOD CODE	MODEL	ÖLÇÜ SIZE	g	TL/Ad.
07410 50 010	el tipi / with handle	10	1400	1 2.015,25

07410

Makaralı Uzatma Kablosu (Ayaklı)
Extension Cord Reel (With Stand)



Kablo / Cable ø 3x1.5 mm

KOD CODE	MODEL	ÖLÇÜ SIZE	g	TL/Ad.
07410 50 025	ayaklı / with stand	25	4130	1 3.561,25
07410 50 050	ayaklı / with stand	50	6745	1 7.110,75



DÖVME ÇELİK MENGENE / FORGED STEEL VICE WITH SWIVEL BASE

Isıl işlem sonrasında ilave olarak yapılan
indüksiyonda sertleştirme işlemi ile güçlü tutuş
sağlayan özel profilli çeneler

Heat treated and induction hardened special profile jaws
for powerful grip

İndüksiyonda
sertleştirilmiş darbeye
dayanıklı yüzeyler

Induction hardened impact
resistant surfaces

Yüksek
karbonlu sıcak dövme
çeliği ile artırılmış
dayanım

Improved lifetime with hot
forged high carbon steel

Elektrostatik fırın
boya ile korozyon
direnci sağlanmış
yüzeyler

High corrosion
resistance with
electrostatic powder
paint

İndüksiyonda
sertleştirme ile
kullanım ömrü
arttırılmış, korozyona
karşı çinko ile
kaplanmış ilerleme mili

High strength alloyed steel.
High corrosion protection
with chrome over nickel
plating

Yüksek mukavemetli,
alaşımli çelik
Nikel üzerine krom
kaplama ile sağlanan,
korozyon direncinde üst
seviye koruma

High strength alloyed steel.
High corrosion protection
with chrome over nickel
plating

Çevirme kolunun
yerinden çıkmaması için
kullanılan kauçuklar

Rubber stoppers to keep
the bar on the spindle

Çelik döküm
mengene altlığı

Cast steel base plate

Mengenenin 360°
dönmesini sağlayan
çelik döner parça



Vice plate for 360° rotation

7401

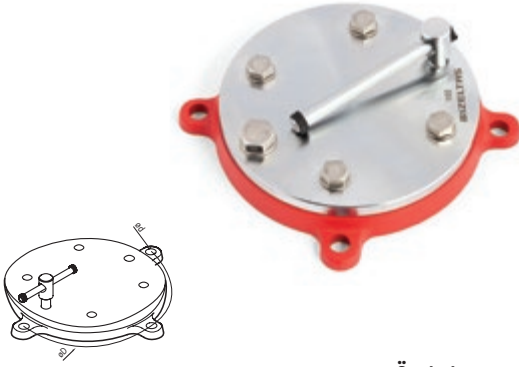
Mengene Döner Tablası
Swivel Base of Vice



Özel alaşım çelik, Krom kaplı
Special steel, Chrom plated



KOD CODE	ÖLÇÜ SIZE	σd mm	σD mm	 g		TL/Ad.
7401 30 0100	100	10.5	160	1550	1	1.346,00
7401 30 0125	125	12.5	200	2700	1	1.778,25
7401 30 0150	150	12.5	240	3800	1	2.158,50
7401 30 0175	175	12.5	280	6650	1	2.440,25

7400

Dövme Çelik Mengene
Forged Steel Vice



Özel alaşım çelik, Fırın boya
Special steel, Electrostatic Paint



KOD CODE	B mm	W mm	H mm	L mm	 g		TL/Ad.
7400 30 0100	100	125	148	440	5000	1	4.570,00
7400 30 0125	125	155	183	550	11000	1	6.292,00
7400 30 0150	150	180	220	675	20000	1	8.046,50
7400 30 0175	175	205	245	760	29000	1	9.900,00

7400

Dövme Çelik Mengene (Döner Tabla dahil)
Forged Steel Vice with Swivel Base



Özel alaşım çelik, Fırın boya
Special steel, Electrostatic Paint

KOD CODE	B mm	 g		TL/Ad.
7400 00 0100	100	6550	1	5.916,00
7400 00 0125	125	13700	1	8.070,25
7400 00 0150	150	23800	1	10.205,00
7400 00 0175	175	35650	1	12.340,25

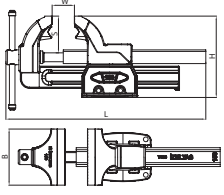
Tesviyeci Mengenesi
Machinist Forged Steel Vise**YENİ
NEW**Özel alaşım çelik, Fırın boya
Special steel, Electrostatic Paint

KOD CODE	B mm	W mm	H mm	L mm	g		TL/Ad.
14000 005070	100	125	120	308	5200	1	3.702,00
14000 005069	125	160	140	388	9300	1	4.807,75
14000 005072	150	190	190	480	18500	1	7.980,75
14000 005071	175	205	200	520	25000	1	9.548,00

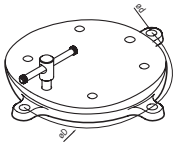
Tesviyeci Mengene Döner Tabla
Swivel Base Of Machinist Vise**YENİ
NEW**Özel alaşım çelik, Fırın boya
Special steel, Electrostatic Paint



KOD CODE	ÖLÇÜ SIZE	ød mm	øD mm	g		TL/Ad.
14000 005126	100	11.5	150	800	1	849,00
14000 005127	125	13.5	185	1300	1	1.058,75
14000 005128	150	16	225	2000	1	1.340,50
14000 005129	175	17.5	250	2600	1	1.471,25

7300

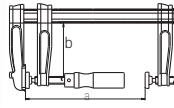
İşkence (Marangoz Mengenesi Plastik Ağızlı)
Carpenter Screw Clamp



Darbeye dayanıklı çeneler
Impact resistant cast iron jaws



KOD CODE		a mm	b mm			TL/Ad.
7300 30 3012	30x12	300	120	1605	5	1.062,75
7300 30 4012	40x12	400	120	1780	5	1.255,75
7300 30 5012	50x12	500	120	1935	5	1.287,25
7300 30 6012	60x12	600	120	2080	5	1.343,50
7300 30 8012	80x12	800	120	2470	5	1.425,00
7300 30 1012	100x12	1000	120	2790	5	1.626,00

7310

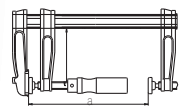
Mini İşkence
Mini Clamp



Alaşımlı alüminyum çeneler
Alloyed aluminum jaws

KOD CODE		a mm	b mm			TL/Ad.
7310 30 1005	10x5	100	50	250	5	457,50
7310 30 1505	15x5	150	50	280	5	481,75
7310 30 2005	20x5	200	50	310	5	499,75
7310 30 2505	25x5	250	50	330	5	521,00
7310 30 3005	30x5	300	50	360	5	539,50

14000 004293

Tekerli Tamirci Kızağı (Büyük) 40"
Mechanics Creeper (Big) 40"



KOD/CODE	Ölçü / SIZE (mm)	Düşük Profil / Low Profile		TL/Ad.
14000 004293	500x1010	65 mm	1	2.015,75

14000 004294

Tekerli Tamirci Kızağı (Küçük) 36"
Mechanics Creeper (Small) 36"



KOD/CODE	Ölçü / SIZE (mm)	Düşük Profil / Low Profile		TL/Ad.
14000 004294	400x900	65 mm	1	1.459,75



- Maket bıçağı ucu, kullanılmadığı zamanlarda gövdenin içinde kapalı konumda tutulmalıdır.
- Maket bıçağı, kullanımı sırasında kesme yapılan parça sabitlenmeli veya düz bir zemin üzerine konularak kesme işlemi güvenli ve dikkatli bir şekilde gerçekleştirilmelidir.
- Maket bıçağı, kullanımı sırasında kesme yönü vücudumuzdan uzaklaştırma yönünde olmalıdır.
- Maket bıçağı, kullanımı sırasında kesilen parçaya göre elimizden veya vücudumuzdan uzak tutulmalıdır.
- Maket bıçağı, kullanımı sırasında kesici uç kesilecek parçaya göre açılmalıdır. Gereğinden fazla açılan uç kırılmaya sebep olacaktır.
- Maket bıçağını amacı dışında kullanmak kazalara neden olacaktır. (Tornavida - Sıyrıcı - Kazıyıcı gibi)



- Maket bıçağı kullanım sırasında koruyucu eldiven ve gözlük kullanılmalıdır.
- Maket bıçağı, ıslak, nemli ve yağlı ortamlarda muhafaza edilmemelidir.
- Maket bıçağı, yıpranmış ve kırılmış uçlarla kullanılmamalıdır. Yıpranan ve kırılan uç, işaretli yerinden kırılmalı veya yan kesici uç ile kullanılmalıdır. Kırılan ve değiştirilen uçlar ayrı bir kutuda toplanmalıdır.
- Maket bıçağının körelen veya yıpranmış ucu, işaretli yerlerden kıracağımız esnada pense vb. ağızları arasında sıkıca tutularak kırılmalıdır. Böylece vücudunuza zarar vermesinin önüne geçilecektir.
- Maket bıçağı, gövdesi zarar görmüş ve kilit mekanizması bozulmuş ise kullanılmamalıdır.
- Maket bıçağı, kesimi yapılacak işe uygun maket bıçağı seçilerek yapılmalıdır.
- Maket bıçağı ucu, gövdeye takılı olarak kullanılmalıdır. Sadece ucu kullanmak ciddi yaralanmalara sebep olabilir.
- Maket bıçağı, takım dolapları ve takım çantası içerisine konulurken ucunun kapalı olduğundan emin olunmalıdır.

- Utility knife blade should be kept in the closed position inside the handle when not in use.
- During the use of the utility knife, the material being cut should be secured or placed on a flat surface to ensure safe and careful cutting.
- The cutting direction during the use of the utility knife should be away from our body.
- During the use of the utility knife, we should keep our hands and body away from the cutting area according to the piece being cut.
- The cutting edge of the utility knife should be angled based on the material to be cut. Opening the edge too much can cause breakage.
- Using the utility knife for purposes other than its intended use can lead to accidents (e.g., As a screwdriver, scraper, or chisel).
- During the use of the utility knife, protective gloves and safety glasses should be worn.
- The appropriate utility knife should be chosen according to the type of cutting work to be done.

- The utility knife blade should be used with the handle attached to the body. Using only the blade can result in serious injuries.
- When placing the utility knife in tool cabinets and tool bags, make sure that the blade is closed.
- The utility knife should not be stored in wet, humid, or oily environments.
- Worn or broken blades of the utility knife should not be used. They should be discarded in a separate box after breakage and replaced with a new cutting edge.
- When breaking a dull or worn blade of the utility knife from the marked areas, it should be held tightly between the jaws of pliers, etc., To prevent harm to the body.
- Utility knives with damaged bodies or faulty locking mechanisms should not be used.



IZELTAS®

MAKET BIÇAKLARI

UTILITY KNIVES

Maket Bıçakları

Utility Knives

Maket Bıçakları Yedek Uçları

Utility Knives Spare Blades



Pro Güvenlikli Otomatik Kilitlemeli Trapez Maket Bıçağı (2 Yedek Bıçaklı)
Pro Safety Auto- Locking Utility Knife**YENİ
NEW**

- **Otomatik Kilit Mekanizması** / Auto-Lock Mechanism
- **Metal Gövde** / Metal-Bodied
- **Kauçuk Kaplamalı** / Rubber Coated
- **Ergonomik Yapı** / Ergonomic Design
- **Trapez Bıçak** / Trapeze Knife
- **2 Yedek Bıçaklı** / 2 Spare Blades
- **Otomatik Emniyet Mandalı** / Auto Safety Button
- **Askı Delikli** / Hanging Hole

KOD/CODE	L mm	g	TL/Ad.
14000 005051	175	205	457,75

Pro Metal Gövde Emniyetli Otomatik Kilitli Maket Bıçağı 18mm
Pro Safety Metal-Bodied Auto-Locking Utility Knife 18 mm**YENİ
NEW**

- **Otomatik Kilit Mekanizması** / Auto-Lock Mechanism
- **Metal Gövde** / Metal-Bodied
- **Kauçuk Kaplamalı** / Rubber Coated
- **Ergonomik Yapı** / Ergonomic Design
- **18 mm Bıçak Genişliği** / 18 mm Blade Width
- **Bıçak Kırma Yeri** / Knife Breaking Part
- **Emniyetli Kesim** / Safety Cutting
- **Askı Delikli** / Hanging Hole

KOD/CODE	L mm	g	TL/Ad.
14000 005050	195	175	375,00

14000 005049

Pro Metal Gövde Maket Bıçağı 18 mm
Pro Metal-Bodied Utility Knife 18 mm

YENİ
NEW



- Otomatik Kilit Mekanizması / Auto-Lock Mechanism
- Metal Gövde / Metal-Bodied
- Kauçuk Kaplamalı / Rubber Coated
- Ergonomik Yapı / Ergonomic Design
- 18 mm Bıçak Genişliği / 18 mm Blade Width
- Bıçak Kırma Yeri / Knife Breaking Part
- Askı Delikli / Hanging Hole

KOD/CODE	L mm			TL/Ad.
14000 005049	172	85	12	230,75

14000 00 5047

Pro Metal Gövde Otomatik Yükllemeli Maket Bıçağı (5 Yedekli) 9 mm
Pro Metal-Bodied Auto-Loading Utility Knife 9 mm

YENİ
NEW



- Otomatik Kilit Mekanizması / Auto-Lock Mechanism
- Metal Gövde / Metal-Bodied
- Kauçuk Kaplamalı / Rubber Coated
- Ergonomik Yapı / Ergonomic Design
- 9 mm Bıçak Genişliği / 9 mm Blade Width
- Otomatik Yükllemeli / Auto Loading
- Askı Delikli / Hanging Hole
- 5 Adet Yedek Bıçaklı / 5 Spare Blades

KOD/CODE	L mm			TL/Ad.
14000 005047	136	80	12	240,50

14000 005053

Pro Metal Gövde Maket Bıçağı 30° 9 mm
Pro Metal-Bodied Utility Knife 30° Angled 9 mm

YENİ
NEW



- Otomatik Kilit Mekanizması / Auto-Lock Mechanism
- Metal Gövde / Metal-bodied
- 9 mm Bıçak Genişliği / 9 mm Blade Width

KOD/CODE	L mm	g		TL/Ad.
14000 005053	134	15	24	48,00

14000 005052

Pro Metal Gövde Maket Bıçağı 9 mm
Pro Metal-Bodied Utility Knife 9 mm

YENİ
NEW



- Otomatik Kilit Mekanizması / Auto-Lock Mechanism
- Metal Gövde / Metal-bodied
- 9 mm Bıçak Genişliği / 9 mm Blade Width
- Kauçuk Kaplamalı / Rubber Coated
- Ergonomik Yapı / Ergonomic Design
- Askı Delikli / Hanging Hole

KOD/CODE	L mm	g		TL/Ad.
14000 005052	130	50	12	163,50

14000 005048

Pro Metal Gövde Emniyetli Otomatik Kilitli Maket Bıçağı 9 mm
Pro Safety Metal Bodied Auto-Locking Utility Knife 9 mm

YENİ
NEW



- Otomatik Kilit Mekanizması / Auto-Lock Mechanism
- Metal Gövde / Metal-bodied
- 9 mm Bıçak Genişliği / 9 mm Blade Width
- Kauçuk Kaplamalı / Rubber Coated
- Ergonomik Yapı / Ergonomic Design
- Emniyetli Kesim / Safety Cutting
- Askı Delikli / Hanging Hole

KOD/CODE	L mm	g		TL/Ad.
14000 005048	162	75	12	288,50

14000 005090

Pro Güvenlikli Trapez Maket Bıçağı Yedek Bıçak 18 mm
Pro Safety Utility Knife Spare Blade 18 mm

YENİ
NEW



Bir Paket 10 Bıçak, Bir Kutu 24 Paket

One Package Contains 10 Blades, One Box Contains 24 Packages

KOD/CODE	Ölçü / SIZE (mm)		TL/Ad.
14000 005090	18	24	73,00

14000 005088

Pro Maket Bıçağı Yedek Bıçak 18 mm
Pro Utility Knife Spare Blade 18 mm

YENİ
NEW



Bir Paket 10 Bıçak, Bir Kutu 24 Paket

One Package Contains 10 Blades, One Box Contains 24 Packages

KOD/CODE	Ölçü / SIZE (mm)		TL/Ad.
14000 005088	18	24	57,75

14000 005089

Pro Maket Bıçağı Yedek Bıçak 9mm
Pro Utility Knife Spare Blade 9 mm

YENİ
NEW



Bir Paket 10 Bıçak, Bir Kutu 24 Paket

One Package Contains 10 Blades, One Box Contains 24 Packages

KOD/CODE	Ölçü / SIZE (mm)		TL/Ad.
14000 005089	9	24	36,50

14000 005091

Pro Maket Bıçağı Yedek Bıçak 30° Açılı 9 mm
Pro Utility Knife Spare Blade 30° 9 mm

YENİ
NEW



Bir Paket 10 Bıçak, Bir Kutu 24 Paket

One Package Contains 10 Blades, One Box Contains 24 Packages

KOD/CODE	Ölçü / SIZE (mm)		TL/Ad.
14000 005091	9	24	36,50

IZELTAS®

MAKASLAR

SHEARS

Demir Kesme Makası
Bolt Cutters

Saç Makasları
Sheet Metal Cutters

Plastik Boru Kesme Makası
Plastic Pipe Cutters

Bağ Makasları
Pruning Shears



**Isıl işlem sonrasında ilave
indüksiyonla sertleştirme ile kullanım
ömrü arttırılmış kesici ağızlar**
Heat-treated and induction hardened cutting
edges for long lifetime

PVC izoleli sap
PVC coated handle

**Kolları birleştirmeye
yarayan kilit mandalı**
Locking latch to keep the
arms closed

Uzun ömürlü yay
Long life spring

**Mangan Fosfat Kaplı
Yüzeyler**
Black finish

**Yüksek karbonlu
sıcak dövme
çeliği ile arttırılmış
dayanım**
High carbon hot forged
steel for improved
performance



IZELTAS YOUTUBE

2350

Demir Kesme Makası
Bolt Cutters



 Yedek parça sayfa 242
Spare parts page 242

Özel alaşımli çelik, Kesici ağızlar indüksiyonda sertleştirilmiş,
Elektrostatik boyanmış çeneler ve bağlantı parçaları dövme
Special steel, Cutters induction hardened,
Electrostatically painted jaws and connection parts drop forged

KOD CODE	L mm	L inch	KAPASİTE CAPACITY ϕ mm	g		TL/Ad.
2350 27 0018	450	18"	6 - 8	1510	1	1.736,00
2350 27 0024	600	24"	8 - 10	2350	1	2.555,00
2350 27 0030	750	30"	9 - 13	3750	1	3.999,50
2350 27 0036	900	36"	11 - 16	5500	1	5.176,25

2350 00 6104

Demir Kesme Makası Sehpası (Dolu)
Bolt Cutters Frame



KOD CODE	İÇERİK CONTENTS	g		TL/Ad.
2350 00 6104	18"(450) - 24"(600) 30"(750) - 36"(900)	21.110	4	16.540,25

6205 27 0240

Alüminyum Ve Sac Kesme Makası Sağ
Snip For Aluminum and Metal Sheet (Right)



Özel alaşımli çelik, Kesici ağızlar indüksiyonda sertleştirilmiş,
Special steel, Cutters induction hardened,

KOD CODE	L mm	L inch	g		TL/Ad.
6205 27 0240	240	10"	380	5	686,50

6206 27 0240

Alüminyum Ve Sac Kesme Makası Sol
Snip For Aluminum and Metal Sheet (Left)



Özel alaşımli çelik, Kesici ağızlar indüksiyonda sertleştirilmiş
Special steel, Cutters induction hardened

KOD CODE	L mm	L inch	g		TL/Ad.
6206 27 0240	240	10"	380	5	686,50

6207 27 0240

Alüminyum Ve Sac Kesme Makası Düz
Snip For Aluminum and Metal Sheet (Flat)



Özel alaşımli çelik, Kesici ağızlar indüksiyonda sertleştirilmiş
Special steel, Cutters induction hardened

KOD CODE	L mm	L inch	g		TL/Ad.
6207 27 0240	240	10"	380	5	686,50

13000 001851

Alüminyum Ve Sac Kesme Makas Takımı (3 Parça)
Aluminum and Metal Sheet Set (3 Pcs)

YENİ NEW



KOD CODE	L mm	L inch	g		TL/Ad.
13000 001851	240	10"	380	5	2.059,50

6210**Kaportacı Makası (Sağ)**
Punch Snip (Right)

DIN 6438



Özel alaşımli çelik, Kesici ağızlar indüksiyonda sertleştirilmiş, PVC izoleli
Special steel, Cutters induction hardened, PVC insulated

KOD CODE	L mm	L inch	g		TL/Ad.
6210 27 0250	250	10"	555	5	863,00
6210 27 0275	275	11"	600	5	944,00
6210 27 0300	300	12"	640	5	1.076,00

6211**Kaportacı Makası (Sol)**
Punch Snip (Left)

DIN 6438



Özel alaşımli çelik, Kesici ağızlar indüksiyonda sertleştirilmiş, PVC izoleli
Special steel, Cutters induction hardened, PVC insulated

KOD CODE	L mm	L inch	g		TL/Ad.
6211 27 0250	250	10"	535	5	863,00
6211 27 0275	275	11"	605	5	944,00
6211 27 0300	300	12"	665	5	1.076,00

6820**Tenekeci Makası**
Tinman's Snip

TSEK



Özel alaşımli çelik, Kesici ağızlar indüksiyonda sertleştirilmiş, PVC izoleli
Special steel, Cutters induction hardened, PVC insulated

KOD CODE	L mm	L inch	g		TL/Ad.
6820 27 0200	200	8"	320	5	580,00
6820 27 0250	250	10"	575	5	741,25
6820 27 0300	300	12"	870	5	807,75

6821**Tenekeci Makası (Yaylı)**
Tinman's Snip (With Spring)

TSEK



Özel alaşımli çelik, Kesici ağızlar indüksiyonda sertleştirilmiş, PVC izoleli
Special steel, Cutters induction hardened, PVC insulated

KOD CODE	L mm	L inch	g		TL/Ad.
6821 27 0250	250	10"	575	5	805,00
6821 27 0300	300	12"	895	5	880,25

6800 27 0180

Kuyumcu Makası (Düz)
Jeweller's Snip (Straight)

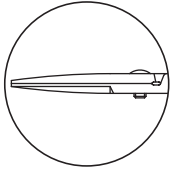

KOD CODE	L mm	L inch	g	TL/Ad.
6800 27 0180	180	7 1/8"	140	700,25

6801 27 0180

Kuyumcu Makası (Eğri)
Jeweller's Snip (Curved)

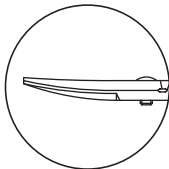

KOD CODE	L mm	L inch	g	TL/Ad.
6801 27 0180	180	7 1/8"	140	766,00

6815 27 0200

Tel Kesme Makası
Bolt Cutters



KOD CODE	L mm	L inch	g	TL/Ad.
6815 27 0200	200	8"	295	354,50

13000 005122

Dövme Tel Kesme Makası
Forging Bolt Cutters



Özel alaşımli çelik, Kesici ağızlar indüksiyonda sertleştirilmiş, PVC izoleli
Special steel, Cutters induction hardened, PVC insulated

KOD CODE	L mm	L inch	g	TL/Ad.
13000 005122	210	7 1/8"	345	1.297,25

6740

Kombine Makas
Multi Purpose Scissors



KOD CODE	L mm	L inch	g	TL/Ad.
6740 27 0140	140	5 1/2"	60	641,25
6740 27 0190	190	7 1/2"	120	752,00



6710 27 0230**Bağ Makası (Lüks)**
Pruning Shears (Lux)

İZELTAS YOUTUBE

Özel alaşımli çelik, Kesici ağızlar indüksiyonda sertleştirilmiş, PVC izoleli
Special steel, Cutters induction hardened, PVC insulated

KOD CODE	L mm	L inch	g	TL/Ad.
6710 27 0230	230	9"	290	5 619,00

6715 27 0225**Bağ Makası (Comfort)**
Pruning Shears (Comfort)

Özel alaşımli çelik, PVC izoleli
Special steel, PVC insulated

KOD CODE	L mm	L inch	g	TL/Ad.
6715 27 0225	225	9"	340	5 941,75

6720 27 0220**Bağ Makası (Hafif Tip)**
Pruning Shears (Light)

Alüminyum gövde, PVC izoleli
Aluminum forged body, PVC insulated

KOD CODE	L mm	L inch	g	TL/Ad.
6720 27 0220	220	8 5/8"	265	5 1.092,75

6712 27 0210**Elma Makası**
Pruning Shears (Fruit)

Özel alaşımli çelik, Kesici ağızlar indüksiyonda sertleştirilmiş, PVC izoleli
Special steel, Cutters induction hardened, PVC insulated

KOD CODE	L mm	L inch	g	TL/Ad.
6712 27 0210	200	8"	260	5 1.094,50

14000 005137

Budama Makası Dövme Örs Çeneli
Anvil Pruning Shears



Alüminyum gövde, PVC izoleli
Aluminum forged body, PVC insulated

KOD CODE	L mm	L inch	g	TL/Ad.
14000 005137	210	8 1/4"	250	750,00

14000 005136

Bağ Makası (Alüminyum Gövdeli)
Pruning Shears (Aluminum-Bodied)



Alüminyum gövde
Aluminum forged body

KOD CODE	L mm	L inch	g	TL/Ad.
14000 005136	220	8 5/8"	315	865,50

14000 005138

Hasat Makası Paslanmaz Düz Ağızlı
Stainless Steel Straight-Edge Harvesting Shears



Paslanmaz Çelik
Stainless Steel

KOD CODE	L mm	L inch	g	TL/Ad.
14000 005138	190	7 1/2"	85	442,25

06760**Plastik Boru Kesme Makası**
Plastic Pipe Cutter Yedek parça sayfa 244
Spare parts page 244

KOD CODE	Ø mm	g	TL/Ad.
06760 50 042	42	400	5 2.365,25
06760 50 063	63	610	5 4.149,25

6850 28 0322**Mini Boru Kesici (Bakır ve Alüminyum İçin)**
Mini Tube Cutter (For Copper and Aluminum) Yedek parça sayfa 244
Spare parts page 244

KOD CODE	ÖLÇÜ SIZE	g	TL/Ad.
6850 28 0322	1/8" - 5/8"	120	1 510,25

6855 28 0330**Standart Boru Kesici (Bakır ve Alüminyum İçin)**
Standard Tube Cutter (For Copper and Aluminum) Yedek parça sayfa 244
Spare parts page 244

KOD CODE	ÖLÇÜ SIZE	g	TL/Ad.
6855 28 0330	1/8" - 1 1/8"	305	1 706,00

6860 28 0635**Teleskopik Boru Kesici (Bakır ve Alüminyum İçin)**
Telescopic Tube Cutter (For Copper and Aluminum) Yedek parça sayfa 244
Spare parts page 244

KOD CODE	ÖLÇÜ SIZE	g	TL/Ad.
6860 28 0635	1/8" - 1 3/8"	470	1 1.500,75

6865 28 1050**Profesyonel Boru Kesici (Çelik İçin)**
Professional Tube Cutter (For Steel) Yedek parça sayfa 244
Spare parts page 244

KOD CODE	ÖLÇÜ SIZE	g	TL/Ad.
6865 28 1050	1/8" - 2"	2380	1 3.786,50



ÇEKTİRMELER

PULLERS

Çektirmeler
Pullers

İç Rulman Çektirmeler
Inside Pullers

Rotil Çektirmeler
Balljoint Pullers

Saplama Sökmeler
Stud Inserters and Removers

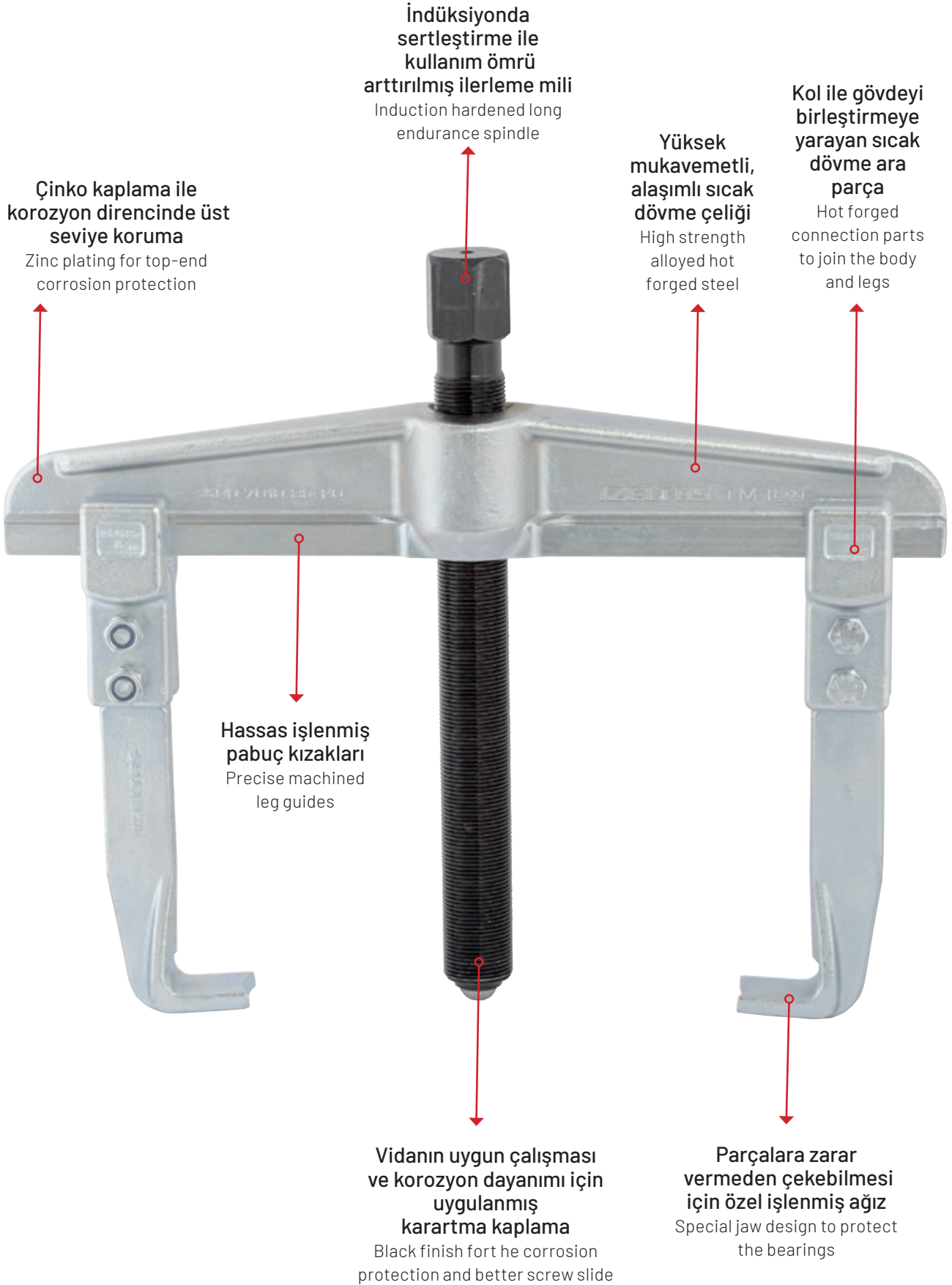

STANDART ÇEKTİRME İKİ KOLLU / STANDARD PULLER TWO ARMS

7010
Standart Çektirme (İki Kollu)
 Standard Puller (Two Arms)

TSEK

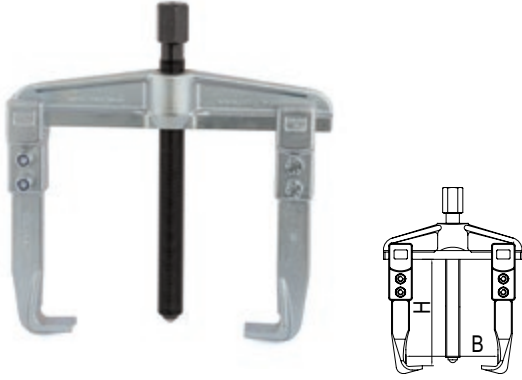

 Yedek parça sayfa 245
 Spare parts page 245

 Krom vanadyum, Çinko kaplı, Kollar sertleştirilmiş,
 Mil indüksiyonda sertleştirilmiş
 Chrom vanadium, Zinc plated,
 Arms hardened, Spindle induction hardened

KOD CODE		B mm	H mm	 g		TL/Ad.
7010 29 0810	8x10	80	100	1080	1	1.736,50
7010 29 1210	12x10	120	100	1235	1	1.857,25
7010 29 1615	16x15	160	150	2850	1	3.165,25
7010 29 2015	20x15	200	150	3060	1	3.462,25
7010 29 2520	25x20	250	200	7450	1	5.980,00
7010 29 3520	35x20	350	200	10000	1	7.263,00
7010 29 5220	52x20	520	200	14100	1	10.675,75

7020
Standart Çektirme (Üç Kollu)
 Standart Puller (Three Arms)

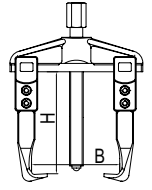
TSEK

 Yedek parça sayfa 245
 Spare parts page 245

 Krom vanadyum, Çinko kaplı, Kollar sertleştirilmiş,
 Mil indüksiyonda sertleştirilmiş
 Chrom vanadium, Zinc plated,
 Arms hardened, Spindle induction hardened

KOD CODE		B mm	H mm	 g		TL/Ad.
7020 29 3720	37x20	370	200	14750	1	13.401,75
7020 29 5220	52x20	520	200	20000	1	18.475,00

7010 00 6105
Standart Çektirme Sehpası (Dolu)
 Display Frame For Pullers

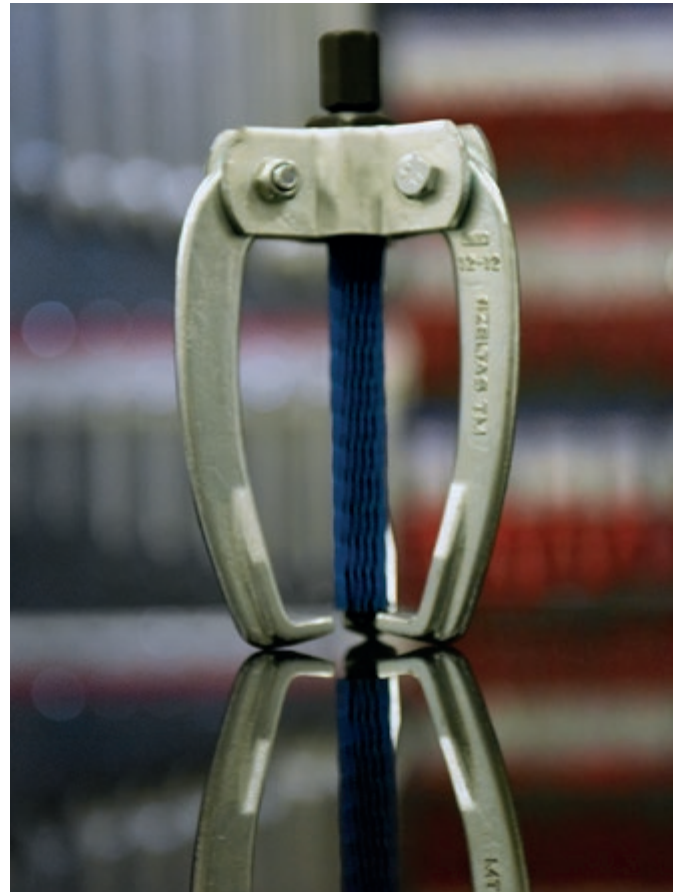
KOD CODE	İÇERİK CONTENTS	 g		TL/Ad.
7010 00 6105	8x10 - 12x10 - 16x15 20x15 - 25x20	17840	5	16.847,00



7030
Master Çektirme (İki Kollu)
 Master Puller (Two Arms)

 Yedek parça sayfa 245
 Spare parts page 245



 Krom vanadyum, Çinko kaplı, Kollar sertleştirilmiş,
 Mil indüksiyonda sertleştirilmiş
 Chrom vanadium, Zinc plated,
 Arms hardened, Spindle induction hardened

KOD CODE		B mm	H mm	g		TL/Ad.
7030 29 0808	8x8	80	80	545	1	699,75
7030 29 1212	12x12	120	120	1075	1	1.442,25
7030 29 1616	16x16	160	160	1885	1	2.170,25
7030 29 2320	23x20	230	200	3240	1	2.950,50

7040
Master Çektirme (Üç Kollu)
 Master Puller (Three Arms)



 Yedek parça sayfa 245
 Spare parts page 245

 Krom vanadyum, Çinko kaplı, Kollar sertleştirilmiş,
 Mil indüksiyonda sertleştirilmiş
 Chrom vanadium, Zinc plated,
 Arms hardened, Spindle induction hardened

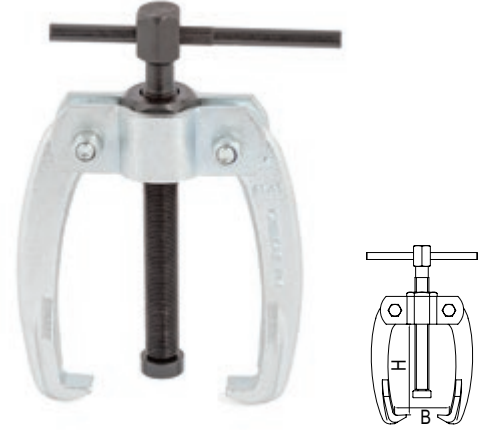
KOD CODE		B mm	H mm	g		TL/Ad.
7040 29 0808	8x8	80	80	680	1	1.340,00
7040 29 1212	12x12	120	120	1355	1	1.960,75
7040 29 1616	16x16	160	160	2320	1	2.883,00
7040 29 2320	23x20	230	200	4025	1	3.881,75

7050
Batarya Çektirme (İki Kollu)
 Battery Puller (Two Arms)

 Yedek parça sayfa 245
 Spare parts page 245



 Krom vanadyum, Çinko kaplı, Kollar sertleştirilmiş,
 Mil indüksiyonda sertleştirilmiş
 Chrom vanadium, Zinc plated,
 Arms hardened, Spindle induction hardened

KOD CODE		B mm	H mm	g		TL/Ad.
7050 29 0604	6x4	60	40	245	1	778,50
7050 29 0606	6x6	60	60	275	1	802,75
7050 29 0808	8x8	80	80	555	1	843,25

7060
Batarya Çektirme (Üç Kollu)
 Battery Puller (Three Arms)

 Yedek parça sayfa 245
 Spare parts page 245

 Krom vanadyum, Çinko kaplı, Kollar sertleştirilmiş,
 Mil indüksiyonda sertleştirilmiş
 Chrom vanadium, Zinc plated,
 Arms hardened, Spindle induction hardened

KOD CODE		B mm	H mm	g		TL/Ad.
7060 29 0604	6x4	60	40	300	1	1.010,75
7060 29 0606	6x6	60	60	345	1	1.274,00
7060 29 0808	8x8	80	80	715	1	1.477,75

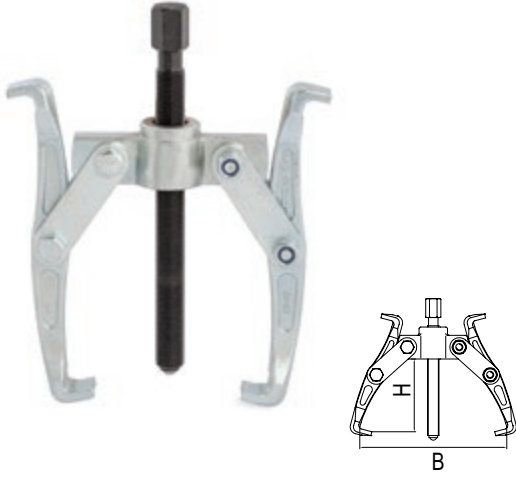

7070 29 2013

S Tipi Çektirme (İki Kollu) S Type Puller (Two Arms)



 **Yedek parça sayfa 245**
Spare parts page 245

**Krom vanadyum, Çinko kaplı, Kollarsertleştirilmiş,
Mil indüksiyonda sertleştirilmiş**
Chrom vanadium, Zinc plated,
Arms hardened, Spindle induction hardened

KOD CODE		B mm	H mm	 g		TL/Ad.
7070 29 2013	20x13	200	130	2420	1	1.916,50

7090 29 2022

Üniversal Çektirme (İki Kollu) Universal Puller (Two Arms)

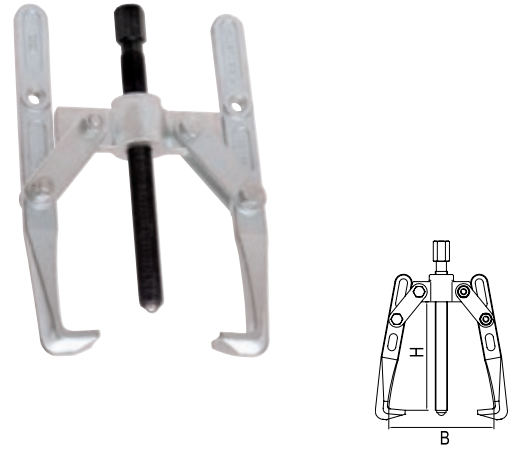

 **Yedek parça sayfa 245**
Spare parts page 245

**Krom vanadyum, Çinko kaplı, Kollar sertleştirilmiş,
Mil indüksiyonda sertleştirilmiş**
Chrom vanadium, Zinc plated,
Arms hardened, Spindle induction hardened

KOD CODE		B mm	H mm	 g		TL/Ad.
7090 29 2022	22x22	220	220	3085	1	2.129,50

7080 29 2013

S Tipi Çektirme (Üç Kollu) S Type Puller (Three Arms)

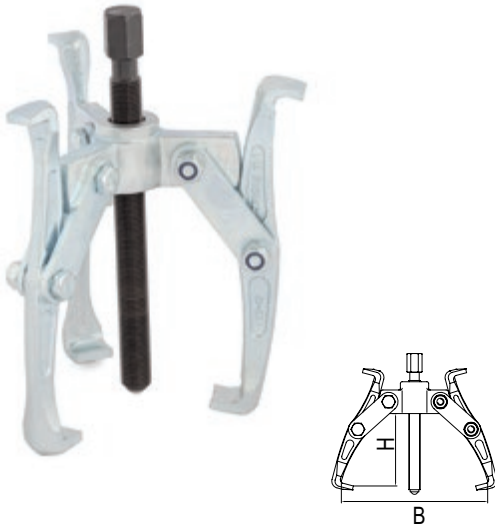

 **Yedek parça sayfa 245**
Spare parts page 245

**Krom vanadyum, Çinko kaplı, Kollar sertleştirilmiş,
Mil indüksiyonda sertleştirilmiş**
Chrom vanadium, Zinc plated,
Arms hardened, Spindle induction hardened

KOD CODE		B mm	H mm	 g		TL/Ad.
7080 29 2013	20x13	200	130	3250	1	2.471,50

7100 29 2022

Üniversal Çektirme (Üç Kollu) Universal Puller (Three Arms)



 **Yedek parça sayfa 245**
Spare parts page 245

**Krom vanadyum, Çinko kaplı, Kollar sertleştirilmiş,
Mil indüksiyonda sertleştirilmiş**
Chrom vanadium, Zinc plated,
Arms hardened, Spindle induction hardened

KOD CODE		B mm	H mm	 g		TL/Ad.
7100 29 2022	22x22	220	220	4125	1	2.791,50

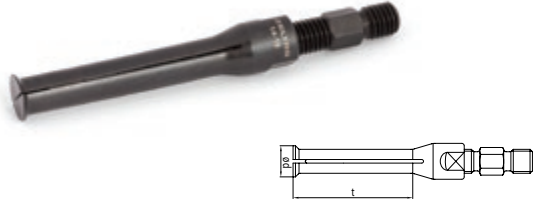
İç Rulman Çektirme Pensleri - Model A
 Internal Expansion Puller - Model A

KOD CODE	σD mm	t mm	Kullanılan Kol / For	Adaptör vidası	g	TL/Ad.
7120 29 0507	5 - 7	30	35 - 75	M10	40	1.597,00
7120 29 0709	7 - 9	30	35 - 75	M10	40	1.597,00
7120 29 0912	9 - 12	30	35 - 75	M10	40	1.479,75
7120 29 1013	10 - 13	30	35 - 75	M10	40	1.479,75
7120 29 1317	13 - 17	50	35 - 75	M10	60	1.479,75
7120 29 1419	14 - 19	60	35 - 75	M10	75	1.516,00
7120 29 1621	16 - 21	60	35 - 75	M10	75	1.516,00
7120 29 1823	18 - 23	60	35 - 75	M10	100	1.814,50
7120 29 2025	20 - 25	60	35 - 75	M10	100	1.915,50
7120 29 2530	25 - 30	60	35 - 75	M10	110	1.995,50
7120 29 3037	30 - 37	70	35 - 75 60 - 130	M10	250	2.311,25
7120 29 3542	35 - 42	70	35 - 75 60 - 130	M10	250	2.429,25
7120 29 3845	38 - 45	70	35 - 75 60 - 130	M10	250	2.560,75
7120 29 4350	43 - 50	70	35 - 75 60 - 130	M10	400	2.911,75

7120 29 2540
İç Rulman Çektirme Pensleri - Model B
 Internal Expansion Puller - Model B

KOD CODE	σD mm	t mm	Kullanılan Kol / For	Adaptör vidası	g	TL/Ad.
7120 29 2540	25 - 40	45	35 - 75 60 - 130	M10	235	3.233,25

İç Rulman Çektirme Kolları
 Arms For Internal Expansion Puller

Krom vanadyum, Çinko kaplı, Kollar sertleştirilmiş,
 Mil indüksiyonda sertleştirilmiş
 Chrom vanadium, Zinc plated,
 Arms hardened, Spindle induction hardened

KOD CODE	Kapasite Capacity mm	Kullanılan pensler / For	Adaptör vidası Screw Adapter	g	TL/Ad.
----------	----------------------	--------------------------	------------------------------	---	--------

7120 29 3575	35 - 75	Model A 5 - 7'den 43 - 50'ye Model B 25 - 40	M10	625	1.626,75
--------------	---------	--	-----	-----	----------

7120 29 6013	60 - 130	Model A 30 - 37'den 43 - 50'ye Model B 25 - 40	M10	1000	3.295,75
--------------	----------	--	-----	------	----------



7122

Dış Rulman Çektirme Çeneleri
Seperator



Krom vanadyum, Çinko kaplı, Kollar sertleştirilmiş,
Mil indüksiyonda sertleştirilmiş
Chrom vanadium, Zinc plated,
Arms hardened, Spindle induction hardened

KOD CODE	Ø mm	Kullanılan Kollar / For	Adaptör vidası	g	TL/Ad.
7122 29 0560	5 - 60	40 - 115	M12	370	1 2.469,00
7122 29 1275	12 - 75	40 - 115	M12	635	1 3.093,25
7122 29 2211	22 - 115	55 - 205	M16	1780	1 4.829,25
7122 29 2515	25 - 155	90 - 260	M20x1.5	3940	1 7.560,00
7122 29 3022	30 - 220	100 - 360	M20x1.5	11000	1 20.659,25
7122 29 4028	40 - 280	140 - 435	M24x3	15000	1 46.142,25

7122

Dış Rulman Çektirme Kolları
Puller Arms For Separator

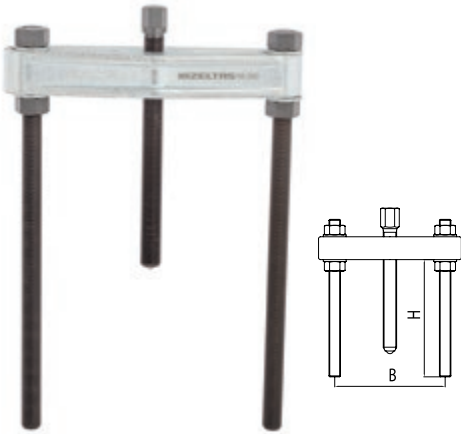

Krom vanadyum, Çinko kaplı, Mil indüksiyonda sertleştirilmiş
Chrom vanadium, Zinc plated,
Arms Spindle induction hardened

KOD CODE	B mm	H mm	Kullanılan Çene / For	Adaptör vidası	g	TL/Ad.
7122 29 4011	40-115	150	5 - 60 12 - 75	M12	990	1 4.601,25
7122 29 5520	55-205	210	22 - 115	M16	2700	1 7.283,50
7122 29 9026	90-260	315	25 - 155	M20x1.5	4965	1 10.311,50
7122 29 1036	100-360	305	30 - 220	M20x1.5	7000	1 21.219,75
7122 29 1443	140-435	320	40 - 280	M24x3	11000	1 41.474,50

7126

Rotil Çektirme
Extractor For Ball Joint

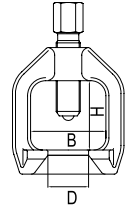

KOD CODE	øD mm	B mm	H mm	g	TL/Ad.
7126 29 0018	18	40	40	315	1 1.384,50
7126 29 0025	25	50	50	540	1 1.898,25
7126 29 0029	29	60	60	915	1 2.524,75
7126 29 0040	40	80	80	1965	1 3.563,75
7126 29 0045	45	90	100	2670	1 4.499,50





IZELTAS®

elta

Anahtarlar

Wrenches

Lokma Anahtarları

Sockets Wrenches

Boru Anahtarları ve Penseler

Pipe Wrenches and Pliers

Tornavida ve Allen Anahtarlar

Screwdrivers and Hex Key Wrenches

Keskiler

Chisels

Genel El Aletleri

General Hand Tools

Makaslar

Shears

Maket Bıçakları

Utility Knives



elta

İki Ağız Anahtar (mm)
Double Ended Open Jaw Wrench (mm)



TS 81
DIN 895



Krom vanadyum, Krom kaplı
Chrom vanadium, Chrom plated

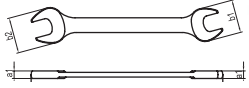

0150

İki Ağız Anahtar Takımı (mm)
Double Ended Open Jaw Wrench Set (mm)



KOD CODE	mm	L mm	a1 mm	b1 mm	b2 mm	g	TL/Ad.
0150 01 0607	6x7	98	3.3	13.5	15.5	10	53,00
0150 01 0809	8x9	108	3.6	17.5	19.5	20	54,00
0150 01 1011	10x11	120	4.1	21.5	23.5	30	58,50
0150 01 1213	12x13	134	4.5	25.5	27.5	40	64,50
0150 01 1415	14x15	150	5	29.5	31.5	60	74,75
0150 01 1617	16x17	163	5.5	33.5	35.5	85	86,25
0150 01 1819	18x19	178	6	37.5	39.5	110	92,50
0150 01 2022	20x22	198	6.5	41.5	45.5	145	105,00
0150 01 2123	21x23	218	6.9	43.5	47.5	175	114,50
0150 01 2426	24x26	236	7.4	49.5	53.5	235	131,50
0150 01 2528	25x28	250	7.8	51.5	57.5	275	158,00
0150 01 2732	27x32	265	8.3	55.5	65.5	345	188,00



KOD CODE	İÇERİK CONTENTS	g	TL/Ad.
0150 00 2108	6x7 - 8x9 - 10x11 12x13 - 14x15 - 16x17 18x19 - 20x22	560	8 588,50
0150 00 2112	6x7 - 8x9 - 10x11 12x13 - 14x15 - 16x17 18x19 - 20x22 - 21x23 24x26 - 25x28 - 27x32	1590	12 1.180,50

0350

Kombine Anahtar (mm) Combination Wrench (mm)



TS 3794
TS ISO 7738 Form A
DIN 3113

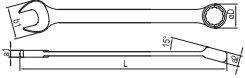

Krom vanadyum, Krom kaplı
Chrom vanadium, Chrom plated

0350

Kombine Anahtar Takımı (mm) Combination Wrench Set (mm)



KOD CODE	mm	L mm	a1 mm	a2 mm	b1 mm	øD mm	g	TL/ Ad.
0350 02 0006	6	95	3.1	5.1	13.5	10	15	10 69,00
0350 02 0007	7	104	3.3	5.5	15.5	11.5	15	10 73,50
0350 02 0008	8	112	3.7	5.9	17.5	13	20	10 79,25
0350 02 0009	9	121	3.9	6.3	19.5	14	25	10 81,75
0350 02 0010	10	130	4.3	6.9	21.5	15.5	30	10 92,25
0350 02 0011	11	138	4.5	7.3	23.5	16.5	35	10 95,25
0350 02 0012	12	146	4.9	7.7	25.5	18	45	10 101,25
0350 02 0013	13	154	5.1	8.1	27.5	19	50	10 102,75
0350 02 0014	14	163	5.5	8.7	29.5	21.5	60	10 111,00
0350 02 0015	15	171	5.7	9.1	31.5	22	70	10 118,50
0350 02 0016	16	180	6.1	9.5	33.5	23	85	10 127,75
0350 02 0017	17	189	6.3	9.9	35.5	25	95	10 136,25
0350 02 0018	18	200	6.7	10.4	37.5	26.5	110	10 151,25
0350 02 0019	19	211	6.9	11	39.5	28	130	10 159,25
0350 02 0020	20	222	7.3	11.4	41.5	29.5	145	10 162,50
0350 02 0021	21	235	7.3	11.4	43.5	31	160	10 188,50
0350 02 0022	22	250	8.1	12.6	45.5	32.5	200	10 215,50
0350 02 0024	24	270	8.7	13.6	49.5	36	250	5 263,25
0350 02 0027	27	300	9.6	14.8	55.5	40	350	5 309,75
0350 02 0030	30	330	10.2	15.8	61.5	44.5	445	5 355,50
0350 02 0032	32	350	10.4	16.2	65.5	47	500	5 372,75

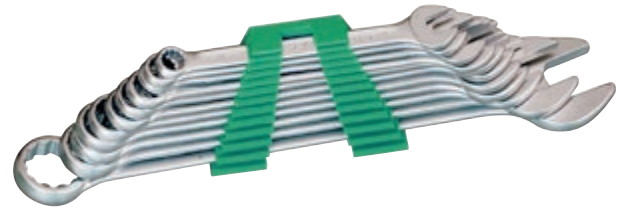

KOD CODE	İÇERİK CONTENTS	g	TL/ Ad.
0350 00 2108	6 - 7 - 8 - 9 - 10 - 13 17 - 19	395	8 794,00
0350 00 2112	8 - 9 - 10 - 11 - 12 13 - 14 - 15 - 16 17 - 19 - 22	855	12 1.420,75
0350 00 2117	6 - 7 - 8 - 9 - 10 11 - 12 - 13 - 14 15 - 16 - 17 - 18 19 - 20 - 21 - 22	1300	17 2.065,50
0350 00 2121	6 - 7 - 8 - 9 - 10 11 - 12 - 13 - 14 15 - 16 - 17 - 18 19 - 20 - 21 - 22 24 - 27 - 30 - 32	2810	21 3.366,75

Yıldız İki Ağız Anahtar (mm)
Double Ended Ring Wrench (mm)



TS 3794
TS ISO 10104 Form B
DIN 838

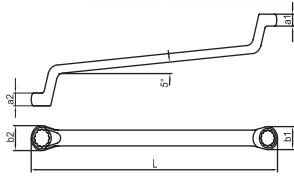

Krom vanadyum, Krom kaplı
Chrom vanadium, Chrom plated

KOD CODE	mm	L mm	a1 mm	a2 mm	b1 mm	b2 mm	g		TL/Ad.
0450 03 0607	6x7	140	4.8	5.2	11	12	45	10	118,50
0450 03 0809	8x9	158	5.4	5.8	13.5	14.5	60	10	120,00
0450 03 1011	10x11	175	6	6.4	16	17.5	90	10	133,50
0450 03 1213	12x13	193	6.6	7.1	19	20	100	10	150,25
0450 03 1415	14x15	210	7.7	8.1	21.5	23.5	140	10	158,00
0450 03 1617	16x17	230	9.2	9.6	25.5	26.5	190	10	178,75
0450 03 1819	18x19	246	10.2	10.6	27.5	29.5	240	10	213,50
0450 03 2022	20x22	280	11.2	11.8	31	34	255	5	233,25
0450 03 2123	21x23	284	11.4	12.2	32.5	35	300	5	267,75
0450 03 2426	24x26	300	12.6	13.2	37	39	335	5	311,50
0450 03 2528	25x28	314	13.6	14.2	38	42	430	5	341,00
0450 03 2732	27x32	329	14.8	15.2	41	49	525	5	376,00

0450

Yıldız İki Ağız Anahtar Takımı (mm)
Double Ended Ring Wrench Set (mm)

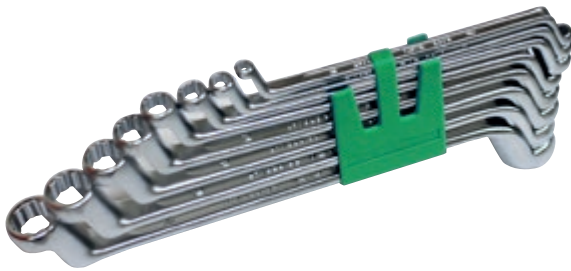

KOD CODE	İÇERİK CONTENTS	g		TL/Ad.
0450 00 2108	6x7 - 8x9 - 10x11 12x13 - 14x15 - 16x17 18x19 - 20x22	1120	8	1.305,75
0450 00 2112	6x7 - 8x9 - 10x11 12x13 - 14x15 - 16x17 18x19 - 20x22 - 21x23 24x26 - 25x28 - 27x32	2710	12	2.602,00

0601

Kurbağacık Anahtar
Adjustable Wrench

TS ISO 6787

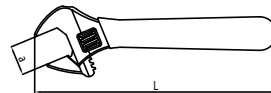

Krom vanadyum, Krom kaplı, PVC izoleli
Chrom vanadium, Chrom plated, PVC Insulated

KOD CODE	L mm	L inch	a mm	g		TL/Ad.
0601 01 0008	206	8"	23	240	5	408,50
0601 01 0010	256	10"	28	400	5	614,50
0601 01 0012	306	12"	34	650	5	812,00

14000 005078

1/4" Cırcır Lokma Anahtar & Bits Set (38 parça, mm)
Socket Wrench & Bits Set (38 Pcs, mm)

YENİ
NEW



1/4"



KOD CODE	LOKMALAR Sockets	AVADANLIKLAR Accessories	g		TL/Ad.
14000 005078	5 - 5.5 - 6 - 7 - 8 9 - 10 - 11 - 12 13 - 14 Altı Köşe Lokma Anahtar Six Points	1/4" Cırcır kolu Ratchet Handle 1/4" Mafsal Universal Joint 1/4" Ara Kol Extension Bar 50 -100 mm 1/4" Derin Lokma Tornavida Adaptörü Spindle Handle SL3 - SL4 - SL5 SL6 PH1 - PH2 - PH3 PH4 PZ1 - PZ2 - PZ3 H3 - H4 - H5 - H6 T10 - T15 - T20 T25 - T27 - T30 T40	790	38	2.307,75

14000 005080

Adaptörlü Bits Uç Set (71 Parça, mm)
Bits Set (71 Pcs)

YENİ
NEW



KOD CODE	AVADANLIKLAR Accessories	g		TL/Ad.
14000 005080	Universal Bits Adaptörü Universal Bits Adapter Hızlı Değişirme Bits Adaptörü Quick Change Bits Adapter SL4 - SL6 (75 mm) SL4 - SL6 (25 mm) PH1 - PH2 - PH3 (75 mm) PH1 - PH2 - PH3 (25 mm) PZ1 - PZ2 (75 mm) PZ1 - PZ2 - PZ3 (25 mm) H2 - H2.5 - H3 - H4 - H5 H8 (25 mm) T20 - T25 (75mm) T10 - T15 - T20 - T25 - T27 T30 - T40 (25mm)	750	71	2.115,50

14000 005079

1/4" Cırcır Lokma Anahtar & Bits Set (23 parça, mm)
Socket Wrench & Bits Set (23 Pcs)

YENİ
NEW



1/4"



KOD CODE	LOKMALAR Sockets	AVADANLIKLAR Accessories	g		TL/Ad.
14000 005079	5 - 6 - 7 - 8 10 - 12 - 13 Altı Köşe Lokma Anahtar Six Points	1/4" Bits / Lokma Tutucu Cırcır Kolu 1/4" Ara Kol Extension Bar 50 mm Hızlı Değişirme Bits Adaptörü SL4 - SL6 PH1 - PH2 H4 - H5 - H6 T15 - T20 - T25 T27 - T30 - T40	425	23	2.307,75

Havali aletler ile kullanmayınız / Do not use with power-tools

1/2" Altı Köşe Lokma Anahtar (mm)
Socket Wrench 6 Points (mm)

TS ISO 2725-1
DIN 3124



1/2"

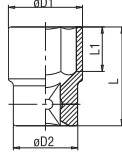

Krom vanadyum, Krom kaplı
Chrom vanadium, Chrom plated

KOD CODE	mm	σ D1 mm	σ D2 mm	L mm	L1 mm	g		TL/ Ad.
1115 06 0010	10	15.4	22	38	8	60	10	87,25
1115 06 0011	11	16.6	22	38	8	60	10	87,25
1115 06 0012	12	17.9	22	38	9	60	10	87,25
1115 06 0013	13	19	22	38	10	60	10	90,75
1115 06 0014	14	20.4	22	38	11	60	10	90,75
1115 06 0015	15	21.6	22	38	11	65	10	90,75
1115 06 0016	16	22.9	22	38	11	70	10	94,25
1115 06 0017	17	24.1	22	38	12	70	10	94,25
1115 06 0018	18	25.4	23	38	13	75	10	94,25
1115 06 0019	19	26.6	23	38	13	75	10	101,25
★ 1115 06 0020	20	28	24	38	13	80	10	101,25
1115 06 0021	21	29.2	24	38	13	80	5	101,25
1115 06 0022	22	30.4	26	38	15	95	5	101,25
1115 06 0023	23	31.2	28	38	15	100	5	110,25
1115 06 0024	24	33	28	38	17	115	5	110,25
1115 06 0026	26	34	30	42	17	130	5	123,50
1115 06 0027	27	36.6	30	42	19	140	5	140,50
1115 06 0028	28	37.5	30	42	20	160	5	147,75
1115 06 0030	30	40	32	44	21	175	5	147,75
1115 06 0032	32	43	34	44	23	180	5	158,25

1514 06 4025

1/2" T Kol
Sliding T - Handle

TS ISO 3315
DIN 3122



1/2"

Krom vanadyum, Krom kaplı
Chrom vanadium, Chrom plated

KOD CODE	L mm	g		TL/ Ad.
★1514 06 4025	250	370	5	333,75

1514 06 6250

1/2" T Kol Adaptörü
Adapter



1/2"

Krom vanadyum, Krom kaplı
Chrom vanadium, Chrom plated

KOD CODE	inch	g		TL/ Ad.
1514 06 6250	3/8"Fx1/2"M	90	5	191,50

1514

1/2" Ara Kol
Extension Bar

TS ISO 3316
DIN 3123



1/2"

Krom vanadyum, Krom kaplı
Chrom vanadium, Chrom plated

KOD CODE	L mm	g		TL/ Ad.
1514 06 4125	125	220	5	175,25
1514 06 4250	250	425	5	303,50

1514 06 4065

1/2" Mafsal
Universal Joint

TS ISO 3316
DIN 3123



1/2"

Krom vanadyum, Krom kaplı
Chrom vanadium, Chrom plated

KOD CODE	L mm	g		TL/ Ad.
1514 06 4065	65	140	5	233,00

1514 06 5250

1/2" Cırcır Kolu (32 Diş)
Ratchet Handle (32 Teeth)

TS ISO 3315
DIN 3122



1/2"

Krom vanadyum, Krom kaplı
Chrom vanadium, Chrom plated

KOD CODE	L mm	g		TL/Ad.
1514 06 5250	250	585	5	710,75

1115 00 2017

1/2" Altı Köşe Lokma Anahtar Takımı (17 Parça, mm)
Socket Wrench Set 6 Points (17 pcs, mm)

1115 00 2024

1/2" Altı Köşe Lokma Anahtar Takımı (24 Parça, mm)
Socket Wrench Set 6 Points (24 pcs, mm)



1/2"



1/2"

KOD CODE	LOKMALAR Sockets	AVADANLIKLAR Accessories	g		TL/Ad.
1115 00 2017		1/2" Cırcır Kolu Ratchet Handle	2650	17	2.826,25
		1/2" T Kol Adaptör Sliding T Handle Adapter			
	10 - 11 - 12 13 - 14 - 15 17 - 19 - 22 24 - 27 - 30 32	1/2" Mafsal Universal Joint			
		1/2" Ara Kol Extension Bar 250 mm			

KOD CODE	LOKMALAR Sockets	AVADANLIKLAR Accessories	g		TL/Ad.
1115 00 2024		1/2" Cırcır Kolu Ratchet Handle	3485	24	3.672,75
		1/2" Mafsal Universal Joint			
	10 - 11 - 12 13 - 14 - 15 16 - 17 - 18 19 - 21 - 22 23 - 24 - 26 27 - 28 - 30 - 32	1/2" T Kol Adaptör Sliding T Handle Adapter			
		1/2" Ara Kol Extension Bar 125 mm			
		1/2" Ara Kol Extension Bar 250 mm			



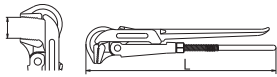

Havali aletler ile kullanmayınız / Do not use with power-tools

Maşalı Boru Anahtarı (85°)
Pipe Wrench (85°)

DIN 5234



Krom vanadyum, Dişler induksiyonda sertleştirilmiş, Elektrostatik boyanmış
Chrom vanadium, Teeth induction hardened, Electrostatically painted

KOD CODE	L mm	 mm	 inch	 g		TL/Ad.
2203 10 0010	325	40	1"	760	1	700,00
2203 10 0015	430	60	1 1/2"	1360	1	1.098,50
2203 10 0020	585	70	2"	2350	1	1.637,50

2401 11 0240

Fort Pense
Waterpump Pliers

TS 60
TS ISO 8976
DIN 8976



2509 11 0225

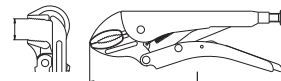
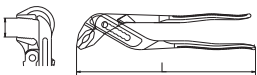

Ayarlı Pense
Grip



Krom vanadyum, Nikel kaplı, PVC izoleli
Chrom vanadium, Nickel plated, PVC Insulated

Çeneler krom vanadyum çeliğinden dövülmüştür, Nikel kaplama,
Kullanım sahası: Yuvarlak ve düz malzemeler
Jaws Chrom vanadium forged, Nickel plated
Applicatation field : Flat and round materials

KOD CODE	L mm	L inch	 mm	 g		TL/ Ad.
2401 11 0240	240	9 1/2"	35	375	5	661,00

KOD CODE	L mm	L inch	 mm	 g		TL/ Ad.
2509 11 0225	225	9"	30	470	5	637,50

3021

Kombine Pense Opak Seri
Combination Pliers

TS 60
DIN ISO 5746



Özel alaşımli çelik, Kesici ağızlar indüksiyonda sertleştirilmiş, PVC saplı
Special steel, Cutters induction hardened, PVC handle

KOD CODE	L mm	L inch	g	□	TL/Ad.
3021 12 1160	160	6 1/4"	200	5	341,75
3021 12 1180	180	7 1/8"	250	5	418,25
3021 12 1200	200	8"	310	5	509,50

3221

Kargaburun Düz Uçlu Opak Seri
Long Nose Pliers (Flat)

TS 60
TS ISO 5745



Özel alaşımli çelik, Kesici ağızlar indüksiyonda sertleştirilmiş, PVC saplı
Special steel, Cutters induction hardened, PVC handle

KOD CODE	L mm	L inch	g	□	TL/Ad.
3221 13 1160	160	6 1/4"	145	5	371,00
3221 13 1200	200	8"	190	5	424,75

3701

Yan Keski Opak Seri
Side Cutting Pliers

TS 60
TS ISO 5749
DIN 5749



Özel alaşımli çelik, Kesici ağızlar indüksiyonda sertleştirilmiş, PVC saplı
Special steel, Cutters induction hardened, PVC handle

KOD CODE	L mm	L inch	g	□	TL/Ad.
3701 16 1140	140	5 1/2"	160	5	324,75
3701 16 1160	160	6 1/4"	220	5	381,25

3801

Kerpeten
Carpenter Pincers

TS 60
TS ISO 9243
DIN ISO 9243



Özel alaşımli çelik, Kesici ağızlar indüksiyonda sertleştirilmiş, Vernikli, PVC izoleli
Special steel, Cutters induction hardened, Lacquered, PVC Insulated

KOD CODE	L mm	L inch	g	□	TL/Ad.
3801 15 0160	160	6 1/4"	235	5	372,00
3801 15 0180	180	7 1/8"	245	5	401,50
3801 15 0200	200	8"	390	5	501,50

3832

Betoncu Kerpeteni
Tower Pincers

TS 60
TS ISO 9242
DIN ISO 9242



Özel alaşımli çelik, Kesici ağızlar indüksiyonda sertleştirilmiş, Vernikli, PVC izoleli
Special steel, Cutters induction hardened, Lacquered, PVC insulated

KOD CODE	L mm	L inch	g	□	TL/Ad.
3832 15 0225	225	9"	335	5	478,00
3832 15 0250	250	10"	415	5	545,00
3832 15 0280	280	11"	475	5	653,50

4170 17 0680

Değişken Uçlu Tornavida
Screwdriver - Reversible

TSEK

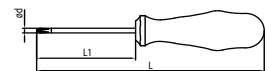

Krom vanadyum, Krom kaplı, PP saplı
Chrom vanadium, Chrom plated, PP handle



KOD CODE	φDxL1 mm	axb mm	+	L mm	g	□	TL/Ad.
4170 17 0680	6x80	1.2x6	Ph2	180	60	10	139,50

Opak Seri Düz Uçlu Tornavida
Screwdriver, Opak, Flat



TS ISO 2380 - 1
DIN ISO 2380-1

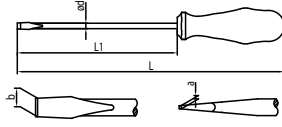

Krom vanadyum, Krom kaplı, PP saplı
Chrom vanadium, Chrom plated, PP handle

KOD CODE	σDxL1 mm	-		L mm	g	□	TL/Ad.
		a mm	b mm				
4150 17 0380	3x80	0.5	3	150	20	10	61,00
4150 17 0480	4x80	0.8	4	170	30	10	70,00
4150 17 4100	4x100	0.8	4	190	40	10	74,75
4150 17 5100	5x100	1.0	5.5	200	55	10	89,75
4150 17 5125	5x125	1.0	5.5	225	60	10	103,75
4150 17 6100	6x100	1.2	6.5	200	70	10	93,50
4150 17 6125	6x125	1.2	6.5	225	75	10	106,00
4150 17 6150	6x150	1.2	6.5	250	80	10	117,25
4150 17 7150	7x150	1.2	8	260	110	10	137,00
★ 4150 17 8150	8x150	1.6	10	260	130	10	148,50
4150 17 8175	8x175	1.6	10	285	135	10	166,25

Opak Seri Yıldız Uçlu Tornavida
Screwdriver, Opak Phillips



TS 59 - 5 ISO 8764
DIN ISO 8764

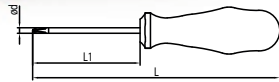

Krom vanadyum, Krom kaplı, PP saplı
Chrom vanadium, Chrom plated, PP handle

KOD CODE	σDxL1 mm	+	L mm	g	□	TL/Ad.
4170 18 4580	4.5x80	Ph1	170	45	10	92,50
4170 18 6100	6x100	Ph2	200	70	10	111,00
4170 18 8150	8x150	Ph3	260	130	10	209,75

Opak Seri Tornavida Seti (6 parça)
Screwdriver Set, Opak (6 Pcs)



KOD CODE	İÇERİK CONTENTS	g	□	TL/Ad.
4150 00 8106	4x80 - 5x100 - 6x125	545	6	606,25
	7x150			
	Düz uçlu / Flat 4.5x80 - 6x100 Yıldız uçlu / Phillips			

Opak Seri Tornavida Seti (7 parça)
Screwdriver Set, Opak (7 Pcs)



KOD CODE	İÇERİK CONTENTS	g	□	TL/Ad.
4150 00 8107	3x80 - 4x100 - 5x125	605	7	726,50
	6x150 - 8x175			
	Düz uçlu / Flat 4.5x80 - 6x100 Yıldız uçlu / Phillips			

★ Stoklarla Sınırlıdır / It is Limited by Stocks.

4908

Allen Anahtar Altı Köşe Standart Boy (mm) Hex Key Wrench Standard Size (mm)

TS ISO 2936
DIN ISO 2936



Krom vanadyum, Siyah Oksit Kaplı
Chrom vanadium, Black finish

KOD CODE	mm	L mm	L1 mm	g	TL/Ad.	
4908 22 0015	1.5	45	14	1.5	10	8,75
4908 22 0020	2	50	16	2	10	11,00
4908 22 0025	2.5	56	18	4	10	12,75
4908 22 0030	3	63	20	6	10	14,75
4908 22 0035	3.5	66	22	8	10	16,75
4908 22 0040	4	70	25	10	10	19,25
4908 22 0050	5	80	28	20	10	20,25
4908 22 0060	6	90	32	30	10	27,50
4908 22 0070	7	95	36	40	10	39,00
4908 22 0080	8	100	36	55	10	45,00
4908 22 0090	9	105	38	75	10	63,25
4908 22 0100	10	112	40	100	10	68,25
4908 22 0120	12	125	45	160	10	99,50

4908

Allen Anahtar Takım Altı Köşe (mm) Hex Key Wrench Set (mm)

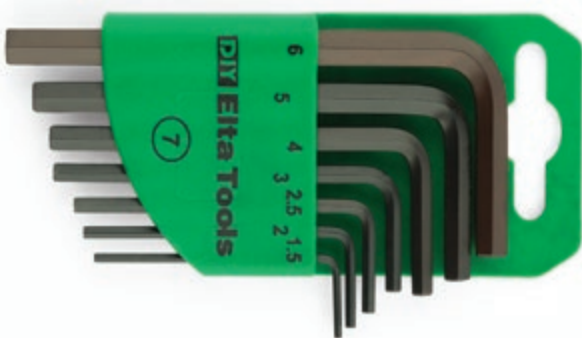

KOD CODE	İÇERİK CONTENTS	g	TL/Ad.	
4908 00 3107	1.5 - 2 - 2.5 - 3 - 4 - 5 - 6	80	7	114,25
4908 00 3109	1.5 - 2 - 2.5 - 3 - 4 - 5 - 6 - 8 - 10	235	9	227,50
4908 00 3110	1.5 - 2 - 2.5 - 3 - 4 - 5 - 6 - 8 - 10 - 12	395	10	327,00

4922

T Tipi Allen Anahtar (mm) Hex Key Wrench T - Handle (mm)



Krom vanadyum, Siyah Oksit Kaplı, PP saplı
Chrom vanadium, Black finish, PP handle

KOD CODE	mm	L mm	L1 mm	g	TL/Ad.	
4922 22 0025	2.5	110	14	15	5	111,75
4922 22 0030	3	125	18	20	5	112,00
4922 22 0040	4	140	22	30	5	113,75
4922 22 0050	5	155	26	55	5	128,25
4922 22 0060	6	170	30	75	5	140,75
4922 22 0070	7	185	34	115	5	145,75
4922 22 0080	8	200	38	150	5	175,50
4922 22 0100	10	220	48	270	5	306,25

4922 00 8108

T Tipi Allen Anahtar Takımı (8 Parça, mm) Hex Key Wrench T - Handle Set (8 Pcs, mm)



KOD CODE	İÇERİK CONTENTS	g	TL/Ad.	
4922 00 8108	2.5 - 3 - 4 - 5 6 - 7 - 8 - 10	730	8	1.234,00

Kaset Allen Anahtar Takımı (6 Parça, mm)
Hex Key Wrench Folding Set (6 Pcs, mm)



Krom vanadyum, Siyah oksid kaplı
Chrom vanadium, Black finish

KOD CODE	İÇERİK CONTENTS	g	TL/Ad.
4915 00 6106	2.5 - 3 - 4 - 5 - 6 - 8	175	546,75

5011

Iskarpela (Düz)
Wood Chisel

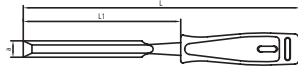

Özel alaşımli çelik, Uç indüksiyonda sertleştirilmiş, PP Saplı
Special steel, induction hardened tips, PP Handle

KOD CODE	a mm	L mm	L1 mm	g	TL/Ad.
5011 23 0006	6	240	120	105	206,50
5011 23 0008	8	242	122	125	219,00
5011 23 0010	10	244	124	140	231,25
5011 23 0012	12	246	126	140	253,75
5011 23 0014	14	248	128	145	262,75
5011 23 0016	16	250	130	165	280,50
5011 23 0018	18	252	132	165	304,50
5011 23 0020	20	254	134	165	337,50
5011 23 0022	22	256	136	180	367,00
5011 23 0024	24	258	138	205	395,25
5011 23 0026	26	260	140	205	410,25
5011 23 0030	30	264	144	205	437,75

5884

Plastik Şerit Metre
Plastic Measuring tapes



KOD CODE	ÖLÇÜ SIZE	g	TL/Ad.
5884 26 0003	3	95	93,50
5884 26 0005	5	195	135,00

5891 26 0830

Testere Kolu
Hacksaw Frame

DIN 6473



KOD CODE	L mm	g	TL/Ad.
5891 26 0830	300	345	334,00

6351

Levye Oluklu
Tyre Lever, Straight

TSEK



Krom vanadyum, Krom kaplı
Chrom vanadium, Chrom plated

KOD CODE	L mm	L inch	g	TL/Ad.
6351 26 0400	400	16"	435	257,50
6351 26 0500	500	20"	680	377,50
6351 26 0600	600	24"	970	491,75

6730 27 0550

Çim Kesme Makası (Düz Ağız)
Grass Shears (Straight)



KOD CODE	L mm	L inch	g		TL/Ad.
6730 27 0550	550	21 5/8"	915	5	583,25

6722 27 0220

Bağ Makası (Hafif Tip)
Pruning Shears (Light)



Alüminyum gövde, Daldırma PVC izoleli
Aluminum forged body, PVC dipped

KOD CODE	L mm	L inch	g		TL/Ad.
6722 27 0220	220	8 5/8"	240	5	636,75

6731 27 0650

Çim Kesme Makası (Eğri Ağız)
Grass Shears (Wave Edges)

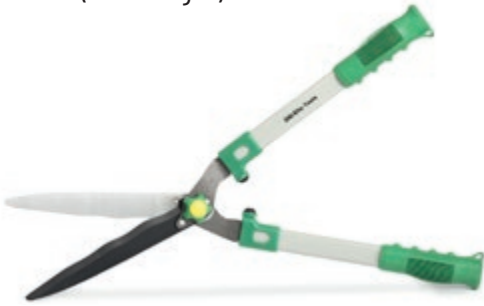

KOD CODE	L mm	L inch	g		TL/Ad.
6731 27 0650	650	25 5/8"	1195	5	1.042,00

8011 31 6001

Teşhir Panosu
Display



6721 27 0205

Bağ Makası (Lüks)
Pruning Shears (Lux)



Özel alaşımli çelik, Kesici ağızlar indüksiyonda sertleştirilmiş, Daldırma PVC izoleli Special steel, Cutters induction hardened, PVC dipped

KOD CODE	L mm	L inch	g		TL/Ad.
6721 27 0205	205	8"	290	5	441,50

KOD CODE	SIZE mm	Cinsi	g		TL/Ad.
8011 31 6001	500x1000x2250	Boş	14000	1	7.375,75

14000 005043

Metal Gövdeli Kilitli Maket Bıçağı 18mm
Metal-Bodied Safety Utility Knife 18 mm



- Otomatik Kilit Mekanizması / Auto-Lock Mechanism
- Metal + ABS Plastik Gövde / Metal-ABS Plastic Bodied
- Ergonomik Yapı / Ergonomic Design
- 18 mm Bıçak Genişliği / 18 mm Blade Width
- Bıçak Kırma Yeri / Knife Breaking Part
- Askı Delikli / Hanging Hole

KOD/CODE	L mm	g	□	TL/Ad.
14000 005043	158	105	12	173,00

14000 005045

Ergonomik Kilitli Maket Bıçağı 9mm
Ergonomic Safety Utility Knife 9 mm



- Otomatik Kilit Mekanizması / Auto-Lock Mechanism
- ABS Plastik Gövde / ABS Plastic Bodied
- Kauçuk Kavramalı / Rubber Coated
- Ergonomik Yapı / Ergonomic Design
- 9 mm Bıçak Genişliği / 9 mm Blade Width
- Bıçak Kırma Yeri / Knife Breaking Part
- Askı Delikli / Hanging Hole

KOD/CODE	L mm	g	□	TL/Ad.
14000 005045	140	35	12	67,25

14000 005044

Ergonomik Kilitli Maket Bıçağı 18mm
Ergonomic Safety Utility Knife 18 mm



- Otomatik Kilit Mekanizması / Auto-Lock Mechanism
- ABS Plastik Gövde / ABS Plastic Bodied
- Kauçuk Kavramalı / Rubber Coated
- Ergonomik Yapı / Ergonomic Design
- 18 mm Bıçak Genişliği / 18 mm Blade Width
- Bıçak Kırma Yeri / Knife Breaking Part
- Askı Delikli / Hanging Hole

KOD/CODE	L mm	g	□	TL/Ad.
14000 005044	172	85	12	115,50

14000 005046

Ergonomik Kilitli Maket Bıçağı Set 18 mm - 9 mm
Ergonomic Safety Utility Knife Set 18 mm - 9 mm



- Otomatik Kilit Mekanizması / Auto-Lock Mechanism
- ABS Plastik Gövde / ABS Plastic Bodied
- Kauçuk Kavramalı / Rubber Coated
- Ergonomik Yapı / Ergonomic Design
- 9-18 mm Bıçak Genişliği / 9-18 mm Blade Width
- Bıçak Kırma Yeri / Knife Breaking Part
- Askı Delikli / Hanging Hole

KOD/CODE	L mm	g	□	TL/Ad.
14000 005044	172	120	12	182,75
14000 005045	140			

IZELTAS®

YEDEK PARÇALAR

SPARE PARTS



Yedek Parçalar
Spare Parts



Kurbağacak Anahtar ve Ayarlı Montaj Anahtarları Yedek Parçaları
 Adjustable Wrench, Spare Parts

	KOD CODE	L mm	L inch	g	TL/ Ad.
Somun Nut 	0600 01 0206	160	6"	5	10 36,00
	0600 01 0208	208	8"	10	10 42,50
	0600 01 0210	260	10"	10	10 56,50
	0600 01 0212	308	12"	20	10 77,25
	0600 01 0215	388	15"	65	10 111,00
Vida Bolt 	0600 01 0306	160	6"	3	10 9,25
	0600 01 0308	208	8"	5	10 14,25
	0600 01 0310	260	10"	5	10 17,25
	0600 01 0312	308	12"	10	10 22,75
	0600 01 0315	388	15"	20	10 28,50
Yay Spring 	0600 01 0406	160	6"	1	10 6,75
	0600 01 0408	208	8"	1	10 6,75
	0600 01 0410	260	10"	1	10 6,75
	0600 01 0412	308	12"	1	10 6,75
	0600 01 0415	388	15"	3	10 6,75

Stilson Anahtar Yedek Parçaları
 Stillson Wrench Spare Part

	KOD CODE	ÖLÇÜ FOR	g	TL/ Ad.
Çene Jaw 	2100 10 0108	8"	80	5 250,75
	2100 10 0110	10"	180	5 371,00
	2100 10 0112	12"	320	5 413,75
	2100 10 0114	14"	400	5 498,75
	2100 10 0118	18"	575	5 670,75
	2100 10 0124	24"	980	5 960,25
Bağlantı Parçası Connection Part 	2100 10 0208	8"	60	5 383,75
	2100 10 0210	10"	95	5 569,75
	2100 10 0212	12"	100	5 624,00
	2100 10 0214	14"	195	5 753,25
	2100 10 0218	18"	345	5 863,25
	2100 10 0224	24"	445	5 1.290,50
Somun Nut 	2100 10 0308	8"	10	5 186,00
	2100 10 0310	10"	30	5 205,50
	2100 10 0312	12"	25	5 214,50
	2100 10 0314	14"	45	5 239,25
	2100 10 0318	18"	75	5 330,25
	2100 10 0324	24"	105	5 361,25

Zincirli Boru Anahtarı Yedek Zinciri
 Spare Chain For Chain Pipe Wrench

KOD CODE	ÖLÇÜ SIZE Inch	L mm	g	TL/ Ad.
14000 005039	4"	555	840	1 787,25
14000 005040	6"	785	1635	1 977,25
14000 005139	8"	990	2400	1 1.119,00

Ağır Tip Boru Anahtarı Yedek Parçaları
 Pipe Wrench, Heavy Duty Spare Parts

	KOD CODE	ÖLÇÜ FOR	g	TL/ Ad.
Çene Jaw 	2110 10 0108	8"	100	5 553,25
	2110 10 0110	10"	205	5 672,25
	2110 10 0112	12"	235	5 1.326,25
	2110 10 0114	14"	400	5 1.414,50
	2110 10 0118	18"	675	5 1.503,00
	2110 10 0124	24"	900	5 2.254,00
	2110 10 0136	36"	1820	5 4.506,50
	2110 10 0148	48"	3410	5 7.422,00
Somun Nut 	2110 10 0308	8"	10	5 182,25
	2110 10 0310	10"	25	5 191,25
	2110 10 0312	12"	35	5 208,75
	2110 10 0314	14"	40	5 252,75
	2110 10 0318	18"	65	5 336,75
	2110 10 0324	24"	115	5 513,00
	2110 10 0336	36"	230	5 951,00
	2110 10 0348	48"	305	5 1.525,00

Alt Çene ve Pim
 Lower Jaw
 and Pin

2110 10 0408	8"	15	5 582,50
2110 10 0410	10"	40	5 645,75
2110 10 0412	12"	60	5 727,75
2110 10 0414	14"	60	5 750,75
2110 10 0418	18"	90	5 777,25
2110 10 0424	24"	125	5 855,00
2110 10 0436	36"	225	5 1.363,75
2110 10 0448	48"	285	5 1.840,75

Maşalı Boru Anahtarı Yedek Somun
 Nut

KOD CODE	ÖLÇÜ FOR	g	TL/ Ad.
2201 10 0110	1"	25	10 42,75
2201 10 0115	1 1/2"	40	10 54,25
2201 10 0120	2"	60	10 71,75
2201 10 0130	3"	75	10 96,00
2201 10 0140	4"	75	10 113,00

Demir Kesme Makası Yedek
 Bolt Cutters Spare Part

**Çene
Jaw**

KOD CODE	ÖLÇÜ SIZE	KAPASİTE CAPACITY ø mm	g	TL/ Ad.
2350 27 0118	18"	6 - 8	850	1 943,50
2350 27 0124	24"	8 - 10	870	1 1.081,50
2350 27 0130	30"	9 - 13	1250	1 1.913,75
2350 27 0136	36"	11 - 16	1850	1 3.533,50

5850
Plastik Çekiç Yedek Başlık
 Plastic Hammer Spare Head

KOD CODE	ØD mm	g	TL/Ad.
5850 25 0130	30	35	10 89,75
5850 25 0140	40	70	10 127,75
5850 25 0150	50	120	10 182,50

6400
Keser Yedek Sapı / Adze Handle

KOD CODE	L mm	g	TL/Ad.
6400 25 0001	400	140	10 116,25

5800
Tesviyeci Çekiç Yedek Sapı (Kamalı)
 Hammer Handle (With Pin)

KOD CODE	L mm	g	g	TL/Ad.
5800 25 0001	260	100	60	10 92,25
5800 25 0002	280	200	60	10 92,50
5800 25 0003	300	300	95	10 103,75
5800 25 0005	320	500	100	10 116,25
5800 25 0010	360	1000	165	10 150,25
5800 25 0015	380	1500	185	10 169,25
5800 25 0020	400	2000	205	10 182,25

5865
Madırğa Yedek Sap (Kamalı)
 Mallet Handle (With Pin)

KOD CODE	L mm	g	TL/Ad.
5865 25 0001	260	1000	210 108,50
5865 25 0002	280	1500	270 119,00

6410
Nacak Yedek Sap (Kamalı)
 Hatchet Handle (With Pin)

KOD CODE	L mm	g	g	TL/Ad.
6410 25 0001	380	800	250	10 349,75

03755
Kablo Sıyrıcı Yedek Bıçağı
 Cable Strippers Spare Blade

KOD CODE	ÖLÇÜ SIZE	g	TL/Ad.
03755 50 625	ø 4-16 / ø 8-28	25	5 127,75

06375
Ayarlı Yağ Filtresi Sökeceği Yedek Kelepçe
 Adjustable Slot Type Oil Filter Wrench Spare Clamp

KOD CODE	Ø mm	g	TL/Ad.
06375 50 010	65	20	5 103,75



6230

Gres Pompası Yedek Ucu
Grease Gun Nozzle



500cc
300cc

KOD CODE	L mm	ø mm	g	TL/Ad.
6230 26 2500	38	15	31	10 82,75

Hortumu
Hose for
Grease Gun



KOD CODE	ø mm	L mm	g	TL/Ad.
6230 26 3300	8	300	34	10 94,25
6230 26 3500	12	500	102	10 172,25

05898

HSS Testere Laması
Hacksaw Blade HSS



KOD CODE	ÖLÇÜ SIZE	g	TL/Ad.
05898 50 283	13x0.65x18	20	100 87,75

05899

Bimetal Testere Laması
Hacksaw Blade Bimetal



KOD CODE	ÖLÇÜ SIZE	g	TL/Ad.
05899 50 283	13x0.65x18	20	100 102,75

6735

Dal Budama Testeresi Yedek Bıçak
Spare Blade for Pruning Saw



KOD CODE	L mm	g	TL/Ad.
6735 27 1300	300	60	5 771,00

06765

Plastik Boru Kesme Makası Bıçağı
Plastic Pipe Cutter Spare Blade



KOD CODE	ÖLÇÜ SIZE	g	TL/Ad.
06765 50 042	42	73	5 1.224,25
06765 50 063	63	105	5 2.273,00

6850

Mini Boru Kesici Bıçağı / Blade For Mini Tube Cutter
Standart Boru Kesici Bıçağı / Blade For Standard Tube Cutter



KOD CODE	ÖLÇÜ SIZE	g	TL/Ad.
6850 28 1322	1/4" - 1 3/8"	5	10 137,00

6865

Profesyonel Boru Kesici Bıçağı
Blade For Professional Tube Cutter



KOD CODE	ÖLÇÜ SIZE	g	TL/Ad.
6865 28 0150	1/8" - 2"	30	5 284,00

14000 005090

Pro Güvenlikli Trapez Maket Bıçağı Yedek Bıçak 18 mm
Pro Safety Utility Knife Spare Blade 18 mm



KOD CODE	Ölçü / SIZE (mm)	TL/Ad.
14000 005090	18	10 73,00

14000 005088

Pro Maket Bıçağı Yedek Bıçak 18 mm
Pro Utility Knife Spare Blade 18 mm



KOD CODE	Ölçü / SIZE (mm)	TL/Ad.
14000 005088	18	10 57,75

14000 005089

Pro Maket Bıçağı Yedek Bıçak 9 mm
Pro Utility Knife Spare Blade 9 mm



KOD CODE	Ölçü / SIZE (mm)	TL/Ad.
14000 005089	9	10 36,50

14000 005091

Pro Maket Bıçağı Yedek Bıçak 30° Açılı 9 mm
Pro Utility Knife Spare Blade 30° 9 mm



KOD CODE	Ölçü / SIZE (mm)	TL/Ad.
14000 005091	9	10 36,50

7010-7020

Standart Çektirme Yedek Parçaları Spare Parts For Standard Pullers

Uzatma Parçası / Connection Part, Extension



KOD CODE	L mm	KULLANILAN ÇEKTİRME FOR	g	TL/Ad.
7010 29 2033	200	8x10 - 12x10	415	1 417,00
7010 29 3033	300	16x15 - 20x15	890	1 725,75
7010 29 4033	400	25x20 - 35x20 37x20 - 52x20	2350	1 1.073,50

Kol / Arm



KOD CODE	L mm	KULLANILAN ÇEKTİRME FOR	g	TL/Ad.
7010 29 0822	8x10 - 12x10	110	1	314,00
7010 29 1622	16x15 - 20x15	330	1	546,00
7010 29 2522	25x20 - 35x20 52x20 - 37x20	775	1	956,50

Bağlantı Parçası / Connection Part



KOD CODE	L mm	KULLANILAN ÇEKTİRME FOR	g	TL/Ad.
7010 29 0833	8x10 - 12x10	160	1	159,00
7010 29 1633	16x15 - 20x15	325	1	273,50
7010 29 2533	25x20 - 35x20 52x20 - 37x20	930	1	479,00

Mil / Spindle



KOD CODE	L mm	KULLANILAN ÇEKTİRME FOR	g	TL/Ad.
7010 29 0844	8x10 - 12x10	185	1	287,25
7010 29 1644	16x15 - 20x15	555	1	547,75
7010 29 2544	25x20	1400	1	942,50
7010 29 3544	35x20 - 37x20	2185	1	1.228,25
7010 29 5244	52x20	3210	1	1.228,25

7030-7040

Master Çektirme Yedek Parçaları/Spare Parts For Master Puller

Kol / Arm



KOD CODE	KULLANILAN ÇEKTİRME FOR	g	TL/Ad.
7030 29 0822	8x8	110	1 171,75
7030 29 1222	12x12	215	1 238,25
7030 29 1622	16x16	345	1 425,00
7030 29 2322	23x20	580	1 578,25

Mil/Spindle



KOD CODE	L mm	KULLANILAN ÇEKTİRME FOR	g	TL/Ad.
7030 29 0844	8x8	180	1	233,25
7030 29 1244	12x12	360	1	343,00
7030 29 1644	16x16	680	1	379,00
7030 29 2344	23x20	1230	1	519,00

7050-7060

Batarya Çektirme Yedek Parçaları Spare Parts For Battery Pullers

Kol / Arm



KOD CODE	KULLANILAN ÇEKTİRME FOR	g	TL/Ad.
7050 29 0422	6x4	40	1 134,00
7050 29 0622	6x6	50	1 150,00
7050 29 0822	8x8	110	1 171,75

Mil / Spindle



KOD CODE	KULLANILAN ÇEKTİRME FOR	g	TL/Ad.
7050 29 0444	6x4	95	1 199,00
7050 29 0644	6x6	105	1 222,50
7050 29 0844	8x8	200	1 280,25

7070-7080

S Tipi Çektirme Yedek Parçaları Spare Parts For S Type Puller

Kol / Arm



KOD CODE	KULLANILAN ÇEKTİRME FOR	g	TL/Ad.
7070 29 2022	20x13	405	1 343,75

Mil / Spindle



KOD CODE	L mm	KULLANILAN ÇEKTİRME FOR	g	TL/Ad.
7070 29 2044	20x13	520	1	479,25

7090-7100

Üniversal Çektirme Yedek Parçaları Spare Parts For Universal Puller

Kol / Arm



KOD CODE	KULLANILAN ÇEKTİRME FOR	g	TL/Ad.
7090 29 2322	22x22	690	1 382,00

Mil / Spindle



KOD CODE	L mm	KULLANILAN ÇEKTİRME FOR	g	TL/Ad.
7090 29 2244	22x22	565	1	504,75



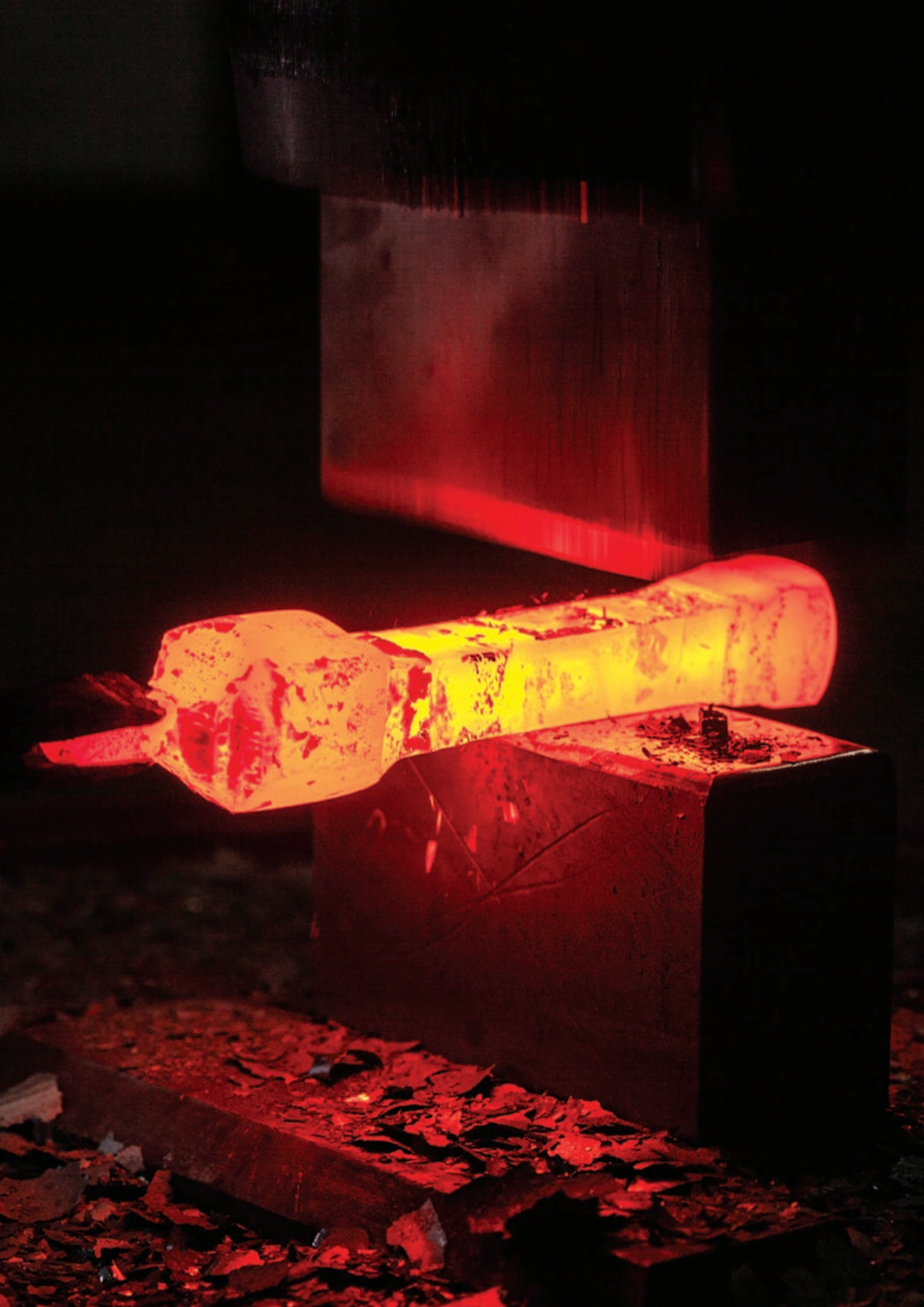

IZELTAS®

TİCARİ TEŞHİR ÜRÜNLERİ

COMMERCIAL DISPLAY PRODUCTS

Ticari Teşhir Ürünleri
Commercial Display Products



1113 31 6100**1/2" Lokma Anahtar Sehpası**
Display Frame for Sockets**1/2"**

KOD CODE	ÖLÇÜ SIZE mm	g	TL/Ad.
1113 31 6100	175x360x605	5800	2.228,75

7010 31 6105**Çektirme Sehpası**
Display Frame For Pullers

KOD CODE	İÇERİK CONTENTS	g	TL/Ad.
7010 31 6105	Boş - Empty	2000	645,75

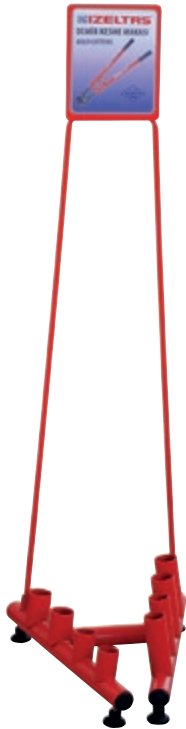
2350 31 6104**Demir Kesme Makası Sehpası**
Display Frame for Bolt Cutters

KOD CODE	İÇERİK CONTENTS	g	TL/Ad.
2350 31 6104	Boş - Empty	7400	3.073,50

7300 31 6150**İşkence Sehpası**
Display Frame for Screw Clamps

KOD CODE	ÖLÇÜ SIZE mm	g	TL/Ad.
7300 31 6150	100x520x1420	8000	2.641,75

8001-8002

Çatal ve Yıldız Anahtar Sehpası
Display Frame For Wrenches



Sacdan imal edilmiş, Fırın boya
Made from metal sheet, Electrostatic paint

KOD CODE	ÖLÇÜ SIZE mm	g	İÇERİK CONTENTS	TL/Ad.
8001 31 6012	160x500	800	Çatal / Open Jaw	1 343,00
8002 31 6012	170x560	1000	Yıldız / Ring	1 428,25

8004 31 6004

Dövme Çelik Mengene Sehpası
Forged Steel Vice Frame



KOD CODE	İÇERİK CONTENTS	g	TL/Ad.
8004 31 6004	Boş - Empty	8000	1 3.275,00

8015 31 6001

Tekerlekli Üçgen Teşhir Standı
Triangular Display Frame



Sacdan imal edilmiş, Fırın boya
Made from metal sheet, Electrostatic paint

KOD CODE	ÖLÇÜ SIZE mm	g	TL/Ad.
8015 31 6001	520x1670	29500	1 4.644,00



İzeltaş El Aletleri Teşhir Panosu, satış noktaları için özel olarak dizayn edilmiştir. Kolayca monte edilebilen 19 ana parçadan oluşan panonun derinliği 46 cm, genişliği 100 cm, yüksekliği 220 cm'dir.

Etkili görünümü ve tüm ürünleri bir arada sergileme özelliği yanında, perakende satışlarda seçme kolaylığı sağlaması bakımından da önem taşımaktadır.

İzeltaş's Product Exhibition Board has been specially designed for selling points. These boards have been formed from easily mountable 19 main parts and have the dimensions as following, width 46 cm, length 100 cm and height 220 cm.

Board features an impressive looking and displays the products all together, which makes it easy to choose desired tools during retail selling activities.

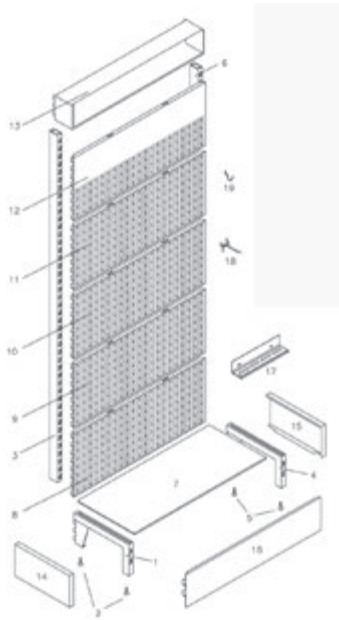
**Montaj Sırası / Montage Order**

1. Ayak / Stand right leg
2. Plastik ayak / Plastic leg
3. Kolon / Stand right column
4. Ayak / Stand left leg
5. Plastik ayak / Plastic leg
6. Kolon / Stand left column
7. Raf / Shelf
8. Delikli pano / Drilled panel
9. Delikli pano / Drilled panel
10. Delikli pano / Drilled panel
11. Delikli pano / Drilled panel
12. Yarım delikli pano / Half - drilled panel
13. Aydınlatma alınlığı / Illumination panel
14. Yan kapak / Side cover
15. Yan kapak / Side cover
16. Ön kapak / Front cover
17. Tornavida askısı / Screwdriver hanger
18. Büyük askı / Long hanger
19. Küçük askı / Short hanger

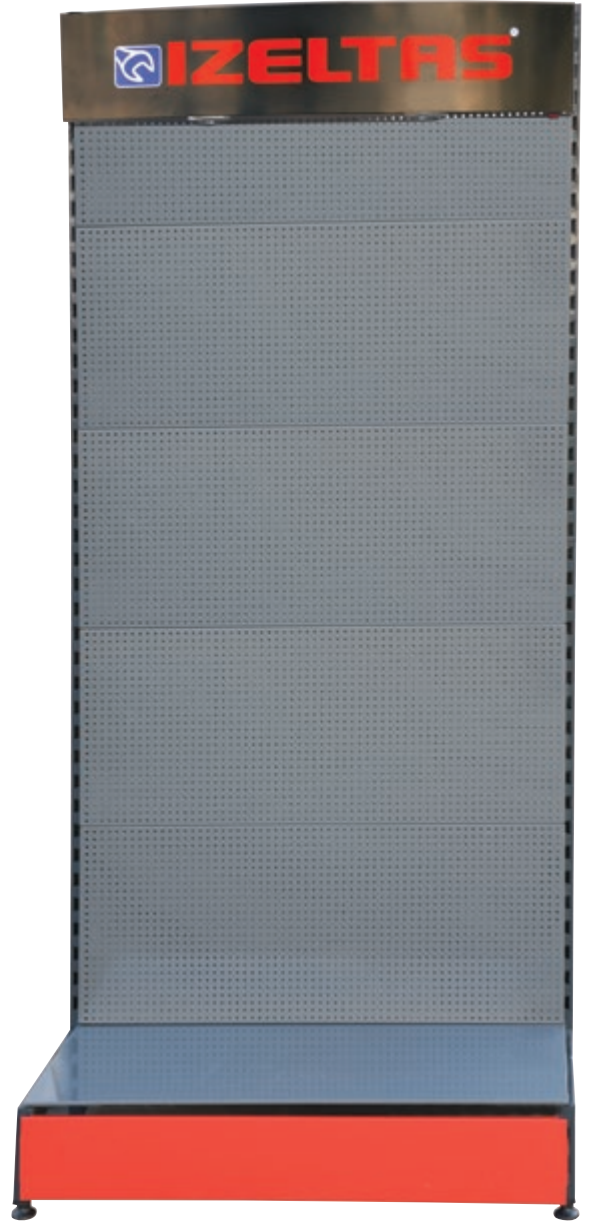
**Büyük Pano
Display Panel (Empty)**

KOD CODE	ÖLÇÜ SIZE mm	Cinsi	g	TL/Ad.
8010 31 6001	460x1000x2200	Boş/Empty	43000	1 8.912,00

TEKNİK BİLGİLER

TECHNICAL INFORMATIONS

Teknik Bilgiler
Technical Informations



İş Güvenliği ve El Aletlerinin Yanlış Kullanımı



Elektrik akımı geçme (1000V üzeri hariç) ihtimali olan tüm yerlerde IEC 60900'a göre izoleli uygun el aletleri kullanılmalıdır.
Hand tools with IEC 60900 compliant isolation must be used for any work involving risk of electrical current (excluding 1000V and above).



Tozlu ve çapaklı alanlarda mutlaka gözlük kullanınız.
Make sure to wear goggles in work areas with dust and burrs.



Lokma anahtarlarınızı uygun ölçülerdeki cıvata da, en geniş yüzeyde dik olarak kullanınız. Lokma anahtarların cıvataya eğik olarak takılıp kullanılması, kavrama yüzeyini azaltarak ürünün kullanım ömrünü kısaltacaktır.
Use box wrenches with bolts of appropriate size, placed perpendicularly on the largest area of contact. Use of a box wrench at an angle will reduce the gripping surface and result in a shorter useful life.



Yüksek sesli ortamlarda mutlaka kulaklık kullanınız.
Make sure to wear ear protection in work areas with high levels of noise.



Çekici amacı dışında kendinden daha sert malzemelere vurmuyunuz, eğik olarak kullanmayınız. Mantarlaşmış bölgeleri mutlaka temizleyerek kullanınız.
Do not use a hammer outside its intended purpose or to hit objects harder than the hammer. Do not hit at an angle. Make sure to clean weakened parts before use.



Kimyasal madde içeren işlerde mutlaka eldiven ve maske kullanınız.
Make sure to wear gloves and facemask for works involving chemical materials.

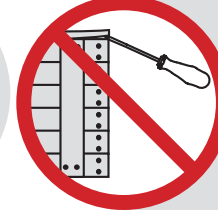

Tornavidayı amacı dışında sökme işlemlerinde kullanmayınız.
Do not use the screwdriver as a levering tool out of its intended purpose.



Anahtarlarınızı, ağız ölçüsüne uygun cıvatalarda kullanınız. Anahtar ve cıvata arasındaki ölçü uyumsuzluğu, üründe ağız aşınmasına neden olur.
Use wrenches with bolts of appropriate size. Size discrepancy between wrench and bolt will lead to wear on tool edge.



Tornavidayı amacı dışında keski gibi ya da darbeli olarak kullanmayınız.
Do not use the screwdriver as a chiselling tool or for impacting out of its intended purpose.



Anahtarların ağızına taşlama işlemi yapmayınız; sert cisimlerle sürterek müdahale etmeyiniz. Bu durum anahtarınızın ağız yapısını bozar.
Do not grind or expose the edge of wrenches to hard objects. This will deform the tool edge structure.



Dolapları çekerek değil iterek kullanınız.
Do not pull the set cabinets. Push to move the cabinets.



Anahtar gövdesine boru takarak kuvvet uygulamayınız. Anahtarınızın ağız yapısının bozulmasına, kırılmalara ve yaralanmalara neden olabilir.
Do not apply force to the wrench by attaching a pipe to the tool body. This may result in deformation of tool edge, breakage or injury.



Dolapların birden fazla çekmecesini aynı anda açık bırakmayınız. Ağırlık merkezi değişerek dolabın devrilmesine neden olacaktır.
Do not leave multiple drawers of set cabinets open at the same time. This will move the centre of gravity and cause toppling.



Anahtar gövdesine çekiç ile darbe uygulamayınız. Ağız yapısında bozulmalara, kırılma ve yaralanmalara neden olabilir.
Do not hit the wrench body with a hammer. This may result in deformation of tool edge, breakage or injury.



Dolapların çekmecelerini ayağınızla kapatmaya ya da basamak, merdiven olarak kullanmaya çalışmayınız. Bu gibi durumlar yaralanmalara sebep olacaktır.
Do not use your foot to close a cabinet drawer or attempt to use cabinet drawers as a stepladder. Such actions will result in injury.

TEKNİK BİLGİLER / TECHNICAL DATA

ANAHTAR AĞZI ÖLÇÜLERİ VE VİDA ÇAPLARI SPANNER JAW WIDTH ACCROSS FLATS and THREAD DIAMETERS

				inch	mm	Whitw.	BS 916 1083	inch	mm
4	2		5/32	0,1562	3,97	8 BA		0,152	3,86
4,5	2,3					7 BA		0,172	4,87
5	2,5		3/16	0,1875	4,76	6 BA		0,193	4,90
5,5	3,5		7/32	0,2187	5,56	5 BA		0,220	5,59
6	26,8		1/4	0,2500	6,35	4 BA		0,248	6,30
						1/16 W		0,256	6,50
7	4		9/32	0,2812	7,14	3 BA		0,282	7,16
						3/32 W		0,297	7,54
7-8	5		5/16	0,3125	7,94	2 BA		0,324	8,23
9	5 Alt		11/32	0,3438	8,73	1/8 W	(3/16)	0,340	8,64
			3/8	0,3750	9,52	1 BA		0,365	9,27
8-10	6		13/32	0,4062	10,32	0 BA	(7/32)	0,413	10,49
11	7		7/16	0,4375	11,11	3/16 W	1/4	0,445	11,30
12									
10-13	8		1/2	0,5000	12,70	1/4 W	5/16	0,525	13,34
14*	8 Alt		9/16	0,5625	14,29				
15	10 KFZ		19/32	0,5938	15,08	5/16 W	3/8	0,600	15,24
16	10		5/8	0,6250	15,88				
13-15-17	10		11/16	0,6875	17,46				
18	12					3/8 W	7/16	0,710	18,03
15-18-19	12		3/4	0,7500	19,05				
20*			25/32	0,7812	19,84				
18-21	14		13/16	0,8125	20,64	7/16 W	1/2	0,820	20,83
22-24	14	12	7/8	0,8750	22,22				
23*						1/2 W	9/16	0,920	23,37
21-24*	16		15/16	0,9375	23,81				
25*-27*		1	1,0000	25,40					
26*						9/16 W	5/8	1,010	25,65
27	18	16	1.1/16	1,0625	26,99				
27-28*-30						5/8 W	(11/16)	1,100	27,94
			1.1/8	1,1250	28,58				
27-30-34	20		1.3/16	1,1875	30,16	11/16 W	3/4	1,200	30,48
32-36-41	22	20	1.1/4	1,2500	31,75				
			1.5/16	1,3125	33,34	3/4 W	7/8	1,300	33,02
34	22		1.3/8	1,3750	34,92	13/16 W	(15/16)	1,390	35,31
36-41	24		1.7/16	1,4375	36,51				
38*			1.1/2	1,5000	38,10	7/8 W	1	1,480	37,59
41-46	27	24	1.5/8	1,6250	41,28				
			1.11/16	1,6875	42,86	1. W	1.1/8	1,670	42,42
			1.3/4	1,7500	44,45				
46-50	30	27	1.13/16	1,8125	46,04				
			1.7/8	1,8750	47,62	1.1/8 W	1.1/4	1,860	47,24
50-55	33	30	2,	2,0000	50,80				
			2.1/16	2,0625	52,39	1.1/4 W	1.3/8	2,050	52,07
55-60	36		2.3/16	2,1875	55,56				
			2.1/4	2,2500	57,15	1.3/8 W	1.1/2	2,220	56,39
60-65	39	36	2.3/8	2,3750	60,32				
			2.7/16	2,4375	61,91	1.1/2 W	1.5/8	2,410	61,21
65	42		2.9/16	2,5625	65,09	1.5/8	1.3/4	2,580	65,53
			2.5/8	2,6250	66,68				
70	45		2.3/4	2,7500	69,85	1.3/4 W	2,	2,760	70,10
			2.13/16	2,8125	71,44				
75	48		2.15/16	2,9375	74,61				
			3,	3,0000	76,20	(1.7/8 W)			76,70
80	52		3.1/8	3,1250	79,38	2. W	2.1/4	3,150	80,01
85	56		3.3/8	3,3750	85,72				
90	60		3.1/2	3,5000	88,90		2.1/2	3,550	90,17
95	64		3.3/4	3,7500	92,25				
			3.7/8	3,8750	98,42		2.3/4	3,890	98,81
100	68								
105	72		4.1/8	4,1250	104,78		3,	4,180	106,17
110	76		4.1/4	4,2500	107,95				
115*	80		4.1/2	4,5000	114,30		3.1/4	4,530	115,06

ANAHTAR İÇİN MİNİMUM DÖNDÜRME MOMENTLERİ TEST TORQUE VALUES FOR SPANNERS ISO 1711-1

	0430 0320 0330 0370	0440	0100 0130	1800	1870 1874
4			1,90		
4,5*			2,64		
5			3,55		
5,5			4,64		
6*	17,6	7,4	5,92	17,6	
7	25,2	11,4	9,12	25,2	
8	34,5	16,6	13,3	34,5	34,5
9*	45,5	23,0	18,4	45,5	45,5
10	58,1	31,0	24,8	58,1	58,1
11	72,7	40,4	32,3	72,7	72,7
12	89,1	51,5	41,2	89,1	89,1
13	107	64,5	51,6	107	107
14*	128	79,4	63,5	128	128
15	150	96,2	77,0	150	150
16	175	115	92,3	175	175
17	201	134	107	201	201
18	230	160	128	230	230
19*	261	186	149	261	261
20*	294	215	172	294	294
21	330	247	198	330	330
22*	368	281	225	368	368
23*	408	319	255	408	408
24	451	359	287	451	451
25*	496	402	322	496	496
26*	544	449	359	544	544
27	594	499	399	594	594
28*	647	552	442	647	647
30	760	670	536	760	760
32*	884	804	643	884	884
34	1019	951	761	1019	1019
36	1165	1117	994	1165	1165
41	1579	1442	1154	1579	1579
46	2067	1816	1453	2067	2067
50	2512	2145	1716	2512	2512
55	3140		2077	3140	3140
60	3849		2471	3849	
65	4021				
70	4658				
75	5394				



VİDA AĞIZ ÖLÇÜLERİ
GUIDELINE FOR SCREWDRIVERS

											
"Metrik Vida Metric screw"	M 1.6 (M 1.7)	M 2	M 2.3	(M 2.3) (M 2.6)	M 3	(M 3.5)	M 4	M 5	M 6	M 8	M 10
Düz başlı Vidalar Flat head screws	0.4 x 3 (3.2)	0.5 x 3.8	0.6 x 4.4	0.6 x 4.5 (5)	0.8 x 5.5	0.8 x 6	1 x 7	1.2 x 8.5	1.6 x 10	2 x 13	2.5 x 16
Düz başlı Vidalar Flat head screws	—	—	—	—	0.8 x 6	0.8 x 7	1 x 8	1.2 x 10	1.6 x 12	2 x 16	2.5 x 20
Düz başlı Vidalar (küçük) Flat head screws (small sizes)	—	—	—	0.4 x 3.5	0.5 x 4	0.5 x 4.5	0.6 x 5.5	0.8 x 6.5	1 x 8	1.2 x 10	1.6 x 13
Oval başlı Vidalar Oval head screws	0.4 x 3	0.5 x 3.8	—	0.6 x 4.7	0.8 x 5.6	—	—	—	—	—	—
Havşa başlı Vidalar Countersank head screws	0.4 x 3	0.5 x 3.8	—	0.6 x 4.7	0.8 x 5.6	0.8 x 6.5	1 x 7.5	1.2 x 9.2	1.6 x 11	2 x 14.5	2.5 x 18

YILDIZ VİDALAR İÇİN UYGUN TORNAVİDA AĞIZ ÖLÇÜLERİ
SUITABLE TIPS FOR CROSS HEAD SCREWS





		
	Yıldız Ağız Ölçüsü Cross Slot Size	Metrik Vidalar Metric Screw
	0	M 1.6 - M 2
	1	M 2 - M 2.5 - M 3
	2	M 3.5 - M 5
	3	M 6
	4	M 8 - M 10



TEKNİK BİLGİLER / TECHNICAL DATA

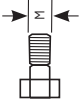
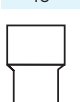



METRİK VİDALAR İÇİN LOKMA SEÇİMİ

GUIDE TO METRIC SIZES COVERED BY SOCKET
WRENCHES FOR EACH DRIVE

	1107 6.3	1110 10	1113 12.5	1119 20	1125 25
					
	1/4"	3/8"	1/2"	3/4"	1"
M 2	4				
	4,5				
M 2.5	5				
M 3	5,5				
M 3.5	6	6			
M 4	7	7			
M 5	8	8	8		
	9	9	9		
M 6	10	10	10	10	
M 7	11	11	11	11	
	12	12	12	12	
M 8	13	13	13	13	
		14	14	14	
		15	15	15	
M 10		16	16	16	
M 10		17	17	17	17
M 12		18	18	18	18
M 12		19	19	19	19
		20	20		
M 14		21	21	21	
M 14		22	22	22	22
		23	23		
M 16			24	24	24
			25		
			26		
M 18			27	27	27
			28		
M 20			30	30	30
M 22			32	32	32
			33	33	33
M 22			34	34	34
M 24				36	36
				38	38
M 27				41	41
					42
M 30				46	46
M 33				50	50
M 36				55	55
M 39				60	60
M 42					65
M 45					70
M 48					75
M 52					

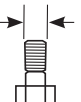
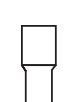
LOKMALAR İÇİN MİN DÖNDÜRME MOMENTLERİ

TEST TORQUE VALUES FOR SOCKET
ISO 1711-1(N-m)

		6,3 1107	10 1110	12,5 1113 1114	20 1119 1120	25 1125
						
	mm	1/4"	3/8"	1/2"	3/4"	1"
M2	4	10,4				
M 2.2	4,5*	12,6				
M 2.5	5	15,1				
M 3	5,5	17,8				
M 3.5	6*	20,6	23,2			
M 4	7	26,8	33,2			
M 5	8	33,6	45,5	94,1		
	9*	41,1	59,9	119,2		
M 6	10	49,1	76,7	147		
M 7	11	57,8	96	178		
	12	67,0	118	212		
M 8	13	68,6	141	249		
	14*	68,6	169	288		
	15		198	331		
	16		225	377		
M 10	17		225	425		
	18		225	477		
M 12	19*		225	531		
	20*		225	569		
	21		225	569	-	
M 14	22*		225	569	569	
	23*			569	569	
M 16	24			569	569	
	25*			569	583	
	26*			569	624	
M 18	27			569	665	
	28*			569	707	
M 20	30			569	795	
M 22	32*			569	888	
	34			569	984	
M 24	36				1084	1677
M 27	41				1353	1910
M 30	46				1569	2143
M 33	50				1569	2329
M 36	55				1569	2562
M 39	60				1569	2795
M 42	65					2795
M 45	70					2795
M 48	75					2795
M 52	80					2795



SIKMA / TEST TORK DEĞERLERİ TIGHTENING / TEST TORQUE VALUES

Önerilen (Bağlayıcı olmayan) cıvata sıkma torkları Nm (Newton Metre)
Suggested (Not Compulsory) Bolt Tightening Torque in Nm (Newton Meter)

Kalite Sınıfı DIN 267'ye Göre Sıkma Değerleri
Tightening Torques Values According to Quality Class DIN 267

	4.6	5.6	6.9	8.8	10.9	12.9
M 2	0,123	0,162	0,314	0,373	0,520	0,628
M 2,2	0,196	0,265	0,510	0,598	0,843	1,010
M 2,5	0,284	0,373	0,726	0,863	1,206	1,451
M 3	0,441	0,588	1,128	1,344	1,883	2,256
M 3,5	0,677	0,902	1,736	2,060	2,893	3,481
M 4	1,000	1,344	2,599	3,040	4,315	5,148
M 5	1,916	2,648	5,099	6,031	8,483	10,200
M 6	3,432	4,511	8,728	10,300	14,710	17,652
M 7	5,590	7,453	14,220	17,162	24,517	28,439
M 8	8,238	10,787	21,575	25,497	35,304	42,168
M 10	16,67	21,575	42,168	50,014	70,608	85,317
M 12	28,44	38,246	73,550	87,279	122,60	147,10
M 14	45,11	60,801	116,70	138,30	194,20	235,40
M 16	69,63	93,163	178,5	210,80	299,10	357,90
M 18	95,12	127,50	245,20	289,3	411,90	490,30
M 20	135,3	180,45	384,10	411,90	578,60	696,30
M 22	182,4	245,16	470,70	559,00	784,50	941,40
M 24	230,5	308,91	598,20	711,00	1000	1196
M 27	343,2	460,90	887,50	1049	1481	1775
M 30	465,8	622,72	1206	1422	2010	2403
M 33	632,5	848,30	1628	1932	2716	3266
M 36	814,0	1089	2099	2481	3491	4197
M 39	1059	1412	2716	3226	4531	5443
M 42	1304	1746	3364	3991	5609	6727
M 45	1638	2177	4207	4992	7012	8414
M 48	1981	2638	5080	6021	8473	10150
M 52	2540	3393	6541	7747	10885	13092
M 56	3168	4227	8149	9650	13582	16279
M 60	3932	5247	10101	11964	16867	20202
M 64	4737	6306	12160	14416	20300	24320

Moment Değerleri Yağlanmış Cıvatalar İçin %20 Azaltılmalıdır.
Torque Values Should be Decreased of 20% for Lubricated Screws

Ölçü Birimleri Measuring Units

Giga	G	1.000.000.000	$\sim 10^9$	1GW= 1 Milyar Watt
Mega	M	1.000.000	$\sim 10^6$	1 MW= 1 Milyon Watt
Kilo	k	1.000	$\sim 10^3$	1 kW= Bin Watt
Milli	m	0.001	$\sim 10^{-3}$	1 mm= Binde Bir Watt
Mikro	m	0.000001	$\sim 10^{-6}$	1 mm= 1 Milyonda Bir Watt
Nano	n	0.000000001	$\sim 10^{-9}$	1 nm= 1 Milyarda Bir Watt

Önemli Ölçülerin Değişim Tablosu Conversion Table For Essential Measuring Units

Uzunluk Length	Metre	m		
Kütle Weight	Kilogram	kg		
Zaman Time	Saniye	s		
Kuvvet Force	Newton	N	=kg m/s ²	1 N= 0.102 kp
Döndürme Mom. Torque	Newtonmetre			9.81 Nm= 1kpm
İş Enerjisi Work	Joule	J	=Nm	
Isı Enerjisi Heat	Joule	J		1 J= 0.239 cal
Güç Power	Watt	W	=Nm/s	1 kW= 1.36 PS=860 kcal/h
Basınç Pressure	Pascal	Pa	=N/m ²	100.000 Pa=1 bar=10 mWS
Elektrik Akımı Electricity Current	Amper	A		
Sıcaklık Temperature	Kelvin	K		1K= -272.15 °C

Döndürme Momenti Dönüşüm Tablosu Conversion Table For Bending Moments

Var Olan Ölçüler/ present units	İstenen Ölçüler / Wanted Units					
	=Ncm	=Nm	=kpcm	=kpm	=lbf.in.	=lbf.ft.
Ncm	1	0.01	0.10197	0.00102	0.0885	0.00738
Nm	100	1	10.197	0.10197	8.851	0.7376
kpcm	9.807	0.09807	1	0.01	0.868	0.0723
kpm	980.07	9.807	100	1	86.796	7.233
lbf.in.	11.298	0.11298	1.152	0.01152	1	0.0833
lbf.ft.	135.58	1.3558	13.825	0.13825	12	1

Newton-Metre ve Librefoot Dönüşüm Tablosu Conversion Table Of Newton-Meter And Librefoot (1 Nm=0.738 lbf.ft.)

Nm	ft.,lbs.									
	0	1	2	3	4	5	6	7	8	9
0	0	0.74	1.48	2.21	2.95	3.69	4.43	5.17	5.90	6.64
10	7.38	8.12	8.86	9.59	10.33	11.07	11.81	12.54	13.28	14.02
20	14.76	15.50	16.2	16.97	17.71	18.45	19.19	19.93	20.65	21.40
30	22.14	22.88	23.62	24.35	25.10	25.83	26.57	27.31	28.04	28.78
40	29.52	30.26	31.00	31.73	32.47	33.21	33.95	34.69	35.42	36.16
50	36.90	37.64	38.38	39.11	39.85	40.59	41.33	42.07	42.80	43.54
60	44.28	45.02	45.76	46.49	47.23	47.97	48.71	49.45	50.18	50.92
70	51.66	52.40	53.14	53.87	54.61	55.35	56.09	56.83	57.56	58.30
80	59.04	59.78	60.52	61.25	62.00	62.73	63.47	64.21	64.94	65.68
90	66.42	67.16	67.90	68.63	69.37	70.11	70.85	71.59	72.32	73.06
100	73.80	74.54	75.28	76.01	76.75	77.49	78.23	78.97	79.70	80.44

Librefoot ve Newton-Metre Dönüşüm Tablosu Conversion Table Of Librefoot And Newton-Meter (1 lbf.ft.=1.356 Nm)

ft.- lbs.	Nm									
	0	1	2	3	4	5	6	7	8	9
0	0	1.36	2.71	4.07	5.42	6.78	8.14	9.49	10.85	12.20
10	13.56	14.92	16.27	17.63	18.98	20.34	21.70	23.05	24.41	25.76
20	27.12	28.48	29.83	31.19	32.54	33.90	35.26	36.61	37.97	39.32
30	40.68	42.04	43.39	44.75	46.10	47.46	48.82	50.17	51.53	52.88
40	54.24	55.60	56.95	58.31	59.66	61.02	62.38	63.73	65.09	66.44
50	67.80	69.16	70.51	71.87	73.22	74.58	75.94	77.29	78.65	80.00
60	81.36	82.72	84.07	85.43	86.78	88.14	89.50	90.85	92.21	93.56
70	94.92	96.28	97.63	98.99	100.34	101.70	103.06	104.41	105.77	107.12
80	108.48	109.84	111.19	112.55	113.90	115.26	116.62	117.97	119.33	120.68
90	122.04	123.40	124.75	126.11	127.46	128.82	130.18	131.53	132.89	134.24
100	135.60	136.96	138.31	139.67	141.02	142.38	143.74	145.09	146.45	147.80

Newton-Metre ve Kilopound-Metre Dönüşüm Tablosu Conversion Table Of Newton-Meter and Kilopound-Meter (1 Nm=0.102 kpm)

Nm	kpm									
	0	1	2	3	4	5	6	7	8	9
0	0.00	1.02	2.04	3.06	4.08	5.10	6.12	7.14	8.16	9.18
100	10.20	11.22	12.24	13.26	14.28	15.30	16.31	17.33	18.35	19.37
200	20.39	21.41	22.43	23.45	24.47	25.49	26.51	27.53	28.55	29.57
300	30.59	31.61	32.63	33.65	34.67	35.69	36.71	37.73	38.75	39.77
400	40.79	41.81	42.83	43.85	44.87	45.89	46.91	47.93	48.95	49.97
500	50.99	52.00	53.02	54.04	55.06	56.08	57.10	58.12	59.14	60.16
600	61.18	62.20	63.22	64.24	65.26	66.28	67.30	68.32	69.34	70.36
700	71.38	72.40	73.42	74.44	75.46	76.48	77.50	78.52	79.54	80.56
800	81.58	82.60	83.62	84.64	85.66	86.68	87.70	88.71	89.73	90.75
900	91.77	92.79	93.81	94.83	95.85	96.87	97.89	98.91	99.93	100.95
1000	101.97	102.99	104.01	105.03	106.05	107.07	108.09	109.11	110.13	111.15



Sertlik Dönüşüm Tablosu

Hardness Conversion Table

Vickers Sertlik Hardness	Brinell Sertlik Hardness	Rockwell Sertlik Hardness		Çekme dayanımı Tensile Strength
HV 30	HB 30	HRB	HRC	sB N/mm ²
80	80.7	36.4	-	270
85	85	42.4	-	290
90	90	47.4	-	310
95	95	52.00	-	320
100	100	56.4	-	340
105	105	60.0	-	360
110	110	63.4	-	380
115	115	66.4	-	390
120	120	69.4	-	410
125	125	72.0	-	420
130	130	74.4	-	440
135	135	76.4	-	460
140	140	78.4	-	470
145	145	80.4	-	490
150	150	82.2	-	500
155	155	83.8	-	520
160	160	85.4	-	540
165	165	86.8	-	550
170	170	88.2	-	570
175	175	89.6	-	590
180	180	90.8	-	600
185	185	91.8	-	620
195	190	91.5	-	640
200	195	94.0	-	660
200	200	95.0	-	670
205	205	95.8	-	680
210	210	96.6	-	710
215	215	97.4	-	720
220	220	98.2	-	730
225	225	99.0	-	750
230	230	-	19.2	760
235	235	-	20.2	780
240	240	-	21.2	800
245	245	-	22.1	820
250	250	-	23.0	830
255	255	-	23.8	850
260	260	-	24.6	870
265	265	-	25.4	880
280	280	-	27.1	900
275	275	-	26.9	920
280	280	-	27.6	940
285	285	-	28.3	950
290	290	-	29.0	970
295	295	-	29.6	990
300	300	-	30.3	1010
310	310	-	31.5	1040
320	320	-	32.7	1080
330	330	-	33.8	1110

Vickers Sertlik Hardness	Brinell Sertlik Hardness	Rockwell Sertlik Hardness		Çekme dayanımı Tensile Strength
HV 30	HB 30	HRB	HRC	sB N/mm ²
340	340	-	34.9	1140
350	350	-	36.0	1170
360	359	-	37.0	1200
370	368	-	38.0	1260
380	376	-	38.9	1260
390	385	-	39.8	1290
400	392	-	40.7	1320
410	400	-	41.5	1350
420	408	-	42.4	1380
440	423	-	44.0	1430
450	430	-	44.8	1460
460	-	-	45.6	-
470	-	-	46.3	-
480	-	-	47.0	-
490	-	-	47.7	-
500	-	-	48.3	-
510	-	-	49.1	-
520	-	-	49.7	-
530	-	-	50.4	-
540	-	-	51.0	-
550	-	-	51.6	-
560	-	-	52.2	-
570	-	-	52.8	-
580	-	-	53.3	-
590	-	-	53.9	-
600	-	-	54.4	-
610	-	-	55.0	-
620	-	-	55.5	-
630	-	-	56.0	-
640	-	-	56.5	-
650	-	-	57.0	-
660	-	-	57.5	-
670	-	-	58.0	-
680	-	-	58.5	-
690	-	-	59.0	-
700	-	-	59.5	-
720	-	-	60.4	-
740	-	-	61.2	-
760	-	-	62.0	-
780	-	-	62.8	-
800	-	-	63.6	-
820	-	-	64.3	-
840	-	-	65.0	-
860	-	-	65.7	-
880	-	-	66.3	-
900	-	-	66.9	-
920	-	-	67.5	-
940	-	-	68.0	-

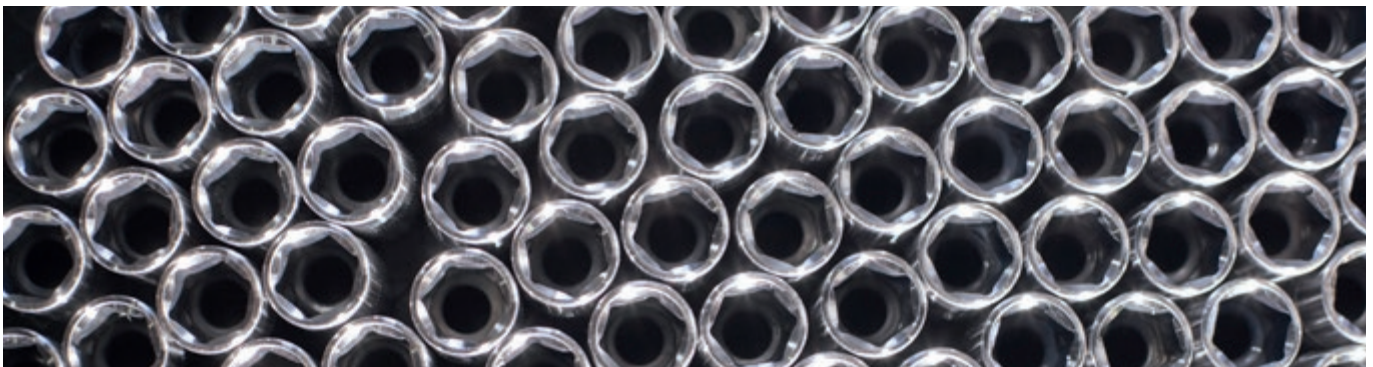

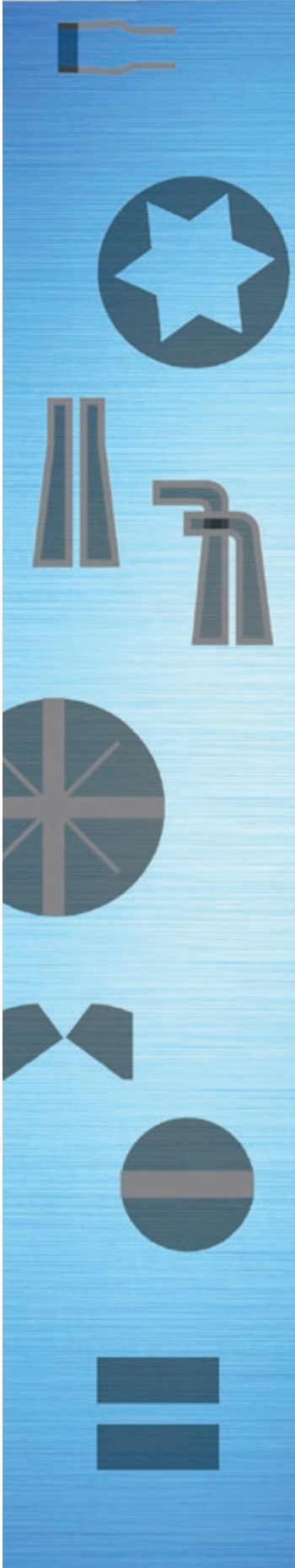
Semboller / Symbols

Anahtar Ağız
Size



Ağız Açıklığı
Opening Limit of Jaws



Altı Köşe Lokma Bijon
Anahtar Ağız
Six Point Sockets



Sekiz Köşe Anahtar Ağız
Eight Point Wrench



On iki Köşe Anahtar Ağız
Twelve Point Wrench



Kare Adaptör
Square Adapter



Kovan Anahtar
Tubular Socket Wrench



Bir Ağız Bijon Anahtar
Single Ended Rim Wrench



TORX® Lokma Anahtar
TORX Socket



Düz Uç
Flat Tip



Yıldız Uç
PHILLIPS® Tip



POZIDRIV® Yıldız Uç
POZIDRIV® Tip



TORX® Uç
TORX® Tip



Delikli TORX® Uç
TORX® with hole



Bits Tutucular
Bit Holders



Allen Anahtar
Hexagonal Allen Keys



Segman
Circclip



Gövde Ağırlık
Weight of Body



Tapa Anahtar
Wrench for Carter Case



İşkence
Screw Clamp



Çektirme
Puller

in.	dec.in.	0"	1"	2"	3"	4"	5"	6"	7"	8"	9"	10"	11"
millimeters (mm)													
0	0	0	25.400 0	50.800 0	76.200 0	101.600 0	127.000 0	152.400 0	177.800 0	203.200 0	228.600 0	254.000 0	279.400 0
1/64	0.015 625	0.396 9	25.796 9	51.196 9	76.596 9	101.996 9	127.396 9	152.796 9	178.196 9	203.596 9	228.996 9	254.396 9	279.796 9
1/32	0.031 25	0.793 8	26.193 8	51.593 8	76.993 8	102.393 8	127.793 8	153.193 8	178.593 8	203.993 8	229.393 8	254.793 8	280.193 8
3/64	0.046 875	1.190 6	26.590 6	51.990 6	77.390 6	102.790 6	128.190 6	153.590 6	178.990 6	204.390 6	229.790 6	255.190 6	280.590 6
1/16	0.062 5	1.587 5	26.987 5	52.387 5	77.787 5	103.187 5	128.587 5	153.987 5	179.387 5	204.787 5	230.187 5	255.587 5	280.987 5
5/64	0.078 125	1.984 4	27.384 4	52.784 4	78.184 4	103.584 4	128.984 4	154.384 4	179.784 4	205.184 4	230.584 4	255.984 4	281.384 4
3/32	0.093 75	2.381 2	27.781 2	53.181 2	78.581 2	103.981 2	129.381 2	154.781 2	180.181 2	205.581 2	230.981 2	256.381 2	281.781 2
7/64	0.109 375	2.778 1	28.178 1	53.578 1	78.978 1	104.378 1	129.778 1	155.178 1	180.578 1	205.978 1	231.378 1	256.778 1	282.178 1
1/8	0.125	3.175 0	28.575 0	53.975 0	79.375 0	104.775 0	130.175 0	155.575 0	180.975 0	206.375 0	231.775 0	257.175 0	282.575 0
9/64	0.140 625	3.571 9	28.971 9	54.371 9	79.771 9	105.171 9	130.571 9	155.971 9	181.371 9	206.771 9	232.171 9	257.571 9	282.971 9
5/32	0.156 25	3.968 8	29.368 8	54.768 8	80.168 8	105.568 8	130.968 8	156.368 8	181.768 8	207.168 8	232.568 8	257.968 8	283.368 8
11/64	0.171 875	4.365 6	29.765 6	55.165 6	80.565 6	105.965 6	131.365 6	156.765 6	182.165 6	207.565 6	232.965 6	258.365 6	283.765 6
3/16	0.187 5	4.762 5	30.162 5	55.562 5	80.962 5	106.362 5	131.762 5	157.162 5	182.562 5	207.962 5	233.362 5	258.762 5	284.162 5
13/64	0.203 125	5.159 4	30.559 4	55.959 4	81.359 4	106.759 4	132.159 4	157.559 4	182.959 4	208.359 4	233.759 4	259.159 4	284.559 4
7/32	0.218 75	5.556 2	30.956 2	56.356 2	81.756 2	107.156 2	132.556 2	157.956 2	183.356 2	208.756 2	234.156 2	259.556 2	284.956 2
15/64	0.234 375	5.953 1	31.353 1	56.753 1	82.153 1	107.553 1	132.953 1	158.353 1	183.753 1	209.153 1	234.553 1	259.953 1	285.353 1
1/4	0.25	6.350 0	31.750 0	57.150 0	82.550 0	107.950 0	133.350 0	158.750 0	184.150 0	209.550 0	234.950 0	260.350 0	285.750 0
17/64	0.265 625	6.746 9	32.146 9	57.546 9	82.946 9	108.346 9	133.746 9	159.146 9	184.546 9	209.946 9	235.346 9	260.746 9	286.146 9
9/32	0.281 25	7.143 8	32.543 8	57.943 8	83.343 8	108.743 8	134.143 8	159.543 8	184.943 8	210.343 8	235.743 8	261.143 8	286.543 8
19/64	0.296 875	7.540 6	32.940 6	58.340 6	83.740 6	109.140 6	134.540 6	159.940 6	185.340 6	210.740 6	236.140 6	261.540 6	286.940 6
5/16	0.312 5	7.937 5	33.337 5	58.737 5	84.137 5	109.537 5	134.937 5	160.337 5	185.737 5	211.137 5	236.537 5	261.937 5	287.337 5
21/64	0.328 125	8.334 4	33.734 4	59.134 4	84.534 4	109.934 4	135.334 4	160.734 4	186.134 4	211.534 4	236.934 4	262.334 4	287.734 4
11/32	0.343 75	8.731 2	34.131 2	59.531 2	84.931 2	110.331 2	135.731 2	161.131 2	186.531 2	211.931 2	237.331 2	262.731 2	288.131 2
23/64	0.359 375	9.128 1	34.528 1	59.928 1	85.328 1	110.728 1	136.128 1	161.528 1	186.928 1	212.328 1	237.728 1	263.128 1	288.528 1
3/8	0.375	9.525 0	34.925 0	60.325 0	85.725 0	111.125 0	136.525 0	161.925 0	187.325 0	212.725 0	238.125 0	263.525 0	288.925 0
25/64	0.390 625	9.921 9	35.321 9	60.721 9	86.121 9	111.521 9	136.921 9	162.321 9	187.721 9	213.121 9	238.521 9	263.921 9	289.321 9
13/32	0.406 25	10.318 8	35.718 8	61.118 8	86.518 8	111.918 8	137.318 8	162.718 8	188.118 8	213.518 8	238.918 8	264.318 8	289.718 8
27/64	0.421 875	10.715 6	36.115 6	61.515 6	86.915 6	112.315 6	137.715 6	163.115 6	188.515 6	213.915 6	239.315 6	264.715 6	290.115 6
7/16	0.437 5	11.112 5	36.512 5	61.912 5	87.312 5	112.712 5	138.112 5	163.512 5	188.912 5	214.312 5	239.712 5	265.112 5	290.512 5
29/64	0.453 125	11.509 4	36.909 4	62.309 4	87.709 4	113.109 4	138.509 4	163.909 4	189.309 4	214.709 4	240.109 4	265.509 4	290.909 4
15/32	0.468 75	11.906 2	37.306 2	62.706 2	88.106 2	113.506 2	138.906 2	164.306 2	189.706 2	215.106 2	240.506 2	265.906 2	291.306 2
31/64	0.484 375	12.303 1	37.703 1	63.103 1	88.503 1	113.903 1	139.303 1	164.703 1	190.103 1	215.503 1	240.903 1	266.303 1	291.703 1
1/2	0.5	12.700 0	38.100 0	63.500 0	88.900 0	114.300 0	139.700 0	165.100 0	190.500 0	215.900 0	241.300 0	266.700 0	292.100 0
33/64	0.515 625	13.096 9	38.496 9	63.896 9	89.296 9	114.696 9	140.096 9	165.496 9	190.896 9	216.296 9	241.696 9	267.096 9	292.496 9
17/32	0.531 25	13.493 8	38.893 8	64.293 8	89.693 8	115.093 8	140.493 8	165.893 8	191.293 8	216.693 8	242.093 8	267.493 8	292.893 8
35/64	0.546 875	13.890 6	39.290 6	64.690 6	90.090 6	115.490 6	140.890 6	166.290 6	191.690 6	217.090 6	242.490 6	267.890 6	293.290 6
9/16	0.562 5	14.287 5	39.687 5	65.087 5	90.487 5	115.887 5	141.287 5	166.687 5	192.087 5	217.487 5	242.887 5	268.287 5	293.687 5
37/64	0.578 125	14.684 4	40.084 4	65.484 4	90.884 4	116.284 4	141.684 4	167.084 4	192.484 4	217.884 4	243.284 4	268.684 4	294.084 4
19/32	0.593 75	15.081 2	40.481 2	65.881 2	91.281 2	116.681 2	142.081 2	167.481 2	192.881 2	218.281 2	243.681 2	269.081 2	294.481 2
39/64	0.609 375	15.478 1	40.878 1	66.278 1	91.678 1	117.078 1	142.478 1	167.878 1	193.278 1	218.678 1	244.078 1	269.478 1	294.878 1
5/8	0.625	15.875 0	41.275 0	66.675 0	92.075 0	117.475 0	142.875 0	168.275 0	193.675 0	219.075 0	244.475 0	269.875 0	295.275 0
41/64	0.640 625	16.271 9	41.671 9	67.071 9	92.471 9	117.871 9	143.271 9	168.671 9	194.071 9	219.471 9	244.871 9	270.271 9	295.671 9
21/32	0.656 25	16.668 8	42.068 8	67.468 8	92.868 8	118.268 8	143.668 8	169.068 8	194.468 8	219.868 8	245.268 8	270.668 8	296.068 8
43/64	0.671 875	17.065 6	42.465 6	67.865 6	93.265 6	118.665 6	144.065 6	169.465 6	194.865 6	220.265 6	245.665 6	271.065 6	296.465 6
11/16	0.687 5	17.462 5	42.862 5	68.262 5	93.662 5	119.062 5	144.462 5	169.862 5	195.262 5	220.662 5	246.062 5	271.462 5	296.862 5
45/64	0.703 125	17.859 4	43.259 4	68.659 4	94.059 4	119.459 4	144.859 4	170.259 4	195.659 4	221.059 4	246.459 4	271.859 4	297.259 4
23/32	0.718 75	18.256 2	43.656 2	69.056 2	94.456 2	119.856 2	145.256 2	170.656 2	196.056 2	221.456 2	246.856 2	272.256 2	297.656 2
47/64	0.734 375	18.653 1	44.053 1	69.453 1	94.853 1	120.253 1	145.653 1	171.053 1	196.453 1	221.853 1	247.253 1	272.653 1	298.053 1
3/4	0.75	19.050 0	44.450 0	69.850 0	95.250 0	120.650 0	146.050 0	171.450 0	196.850 0	222.250 0	247.650 0	273.050 0	298.450 0
49/64	0.765 625	19.446 9	44.846 9	70.246 9	95.646 9	121.046 9	146.446 9	171.846 9	197.246 9	222.646 9	248.046 9	273.446 9	298.846 9
25/32	0.781 25	19.843 8	45.243 8	70.643 8	96.043 8	121.443 8	146.843 8	172.243 8	197.643 8	223.043 8	248.443 8	273.843 8	299.243 8
51/64	0.796 875	20.240 6	45.640 6	71.040 6	96.440 6	121.840 6	147.240 6	172.640 6	198.040 6	223.440 6	248.840 6	274.240 6	299.640 6
13/16	0.812 5	20.637 5	46.037 5	71.437 5	96.837 5	122.237 5	147.637 5	173.037 5	198.437 5	223.837 5	249.237 5	274.637 5	300.037 5
53/64	0.828 125	21.034 4	46.434 4	71.834 4	97.234 4	122.634 4	148.034 4	173.434 4	198.834 4	224.234 4	249.634 4	275.034 4	300.434 4
27/32	0.843 75	21.431 2	46.831 2	72.231 2	97.631 2	123.031 2	148.431 2	173.831 2	199.231 2	224.631 2	250.031 2	275.431 2	300.831 2
55/64	0.859 375	21.828 1	47.228 1	72.628 1	98.028 1	123.428 1	148.828 1	174.228 1	199.628 1	225.028 1	250.428 1	275.828 1	301.228 1
7/8	0.875	22.225 0	47.625 0	73.025 0	98.425 0	123.825 0	149.225 0	174.625 0	200.025 0	225.425 0	250.825 0	276.225 0	301.625 0
57/64	0.890 625	22.621 9	48.021 9	73.421 9	98.821 9	124.221 9	149.621 9	175.021 9	200.421 9	225.821 9	251.221 9	276.621 9	302.021 9
29/32	0.906 25	23.018 8	48.418 8	73.818 8	99.218 8	124.618 8	150.						

KALİTE GÜVENCE TESTLERİ / QUALITY ASSURANCE TEST

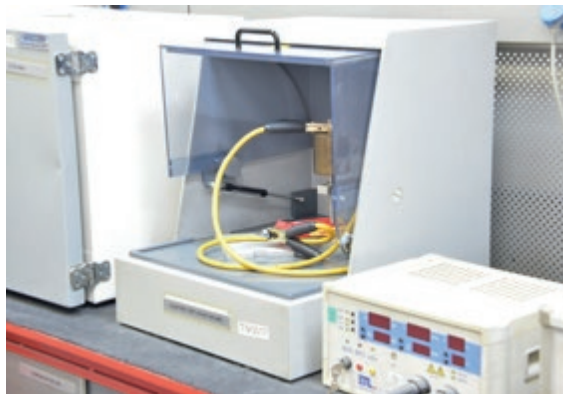



YASAL UYARILAR / LEGAL NOTIE

Bu katalog, önceki baskıların yerine geçer. Katalog içerisinde yer alan ürünlerin teknik özellikleri, görünümü, ölçüleri katalogun yayınlandığı tarihteki mevcut şartları temsil etmektedir. Bu sebeple sipariş verilmeden önce mutlaka firma ile iletişime geçerek sipariş tarihindeki ürünlere ilişkin güncel bilgileri öğrenmenizi öneririz. Katalogta belirtilen ürünlere ait teknik özellikler, görünüm veya ölçü gibi özelliklerin sipariş tarihindeki ürünler ile aynı olmamasından kaynaklı firmanın her ne nam altında olursa olsun hiçbir sorumluluğu bulunmamaktadır. Bu bilgiler doğrultusunda, firma işbu katalog içeriğinde yer alan bilgilerden veya görsel malzemeden kaynaklanabilecek hatalardan, maddi veya manevi zararlardan hiç bir şekil ve surette sorumlu değildir.

Firma katalog içeriğinde yer alan bilgiler veya ürünler ile ilgili önceden haber vermeksizin tek taraflı değişiklikler yapabilir. Firma dilediği zaman, ürünlerinin teknik özelliklerini, görsellerini veya ölçülerini veya ürünlerini tamamen veya kısmen değiştirme hakkına sahiptir. Kataloglarda yer alan görsellerde gözükken montaj, bağlantı detayları, kullanım alanları veya güvenlik önlemleri ürünlerin doğru kullanımı için bir örnek teşkil etmez. Ürünleri kullanan kişiler, katalog içeriğinde yer alan ürünler ile ilgili güvenlik uyarılarına ve ayrıca ürünlere ilişkin ek güvenlik/kullanım talimatlarına uymakla yükümlüdür, aksi takdirde ortaya çıkacak zararlardan firma hiçbir suretle sorumlu tutulamaz.

İşbu Katalog, tüm sayfaları, içeriğindeki bilgiler ve ürünler firmanın fikri ve sınai hakları kapsamında korunmaktadır. Ürün katalogu, içeriğindeki tüm bilgiler ile görseller ve ürünlere ilişkin telif hakkı İzeltaş İzmir El Aletleri Sanayi ve Ticaret A.Ş.'ye aittir. Firmanın yazılı izni olmadan işbu telif hakkına konu ürünlerin, bilgilerin, görsellerin veya katalogun izinsiz kullanılması, yayımlanması, üretilmesi, dağıtılması ve çoğaltılması yasaktır, aksi durum firmanın fikri ve sınai hakkın ihlali sonucunu doğuracaktır.

This catalog replaces previous editions.

The technical features, appearance and dimensions of the products in the catalog represent the current conditions at the date of publication of the catalog. For this reason, we recommend that you contact the company before ordering and learn the current information about the products on the order date. The company does not have any responsibility under any name due to the fact that the technical features, appearance or size of the products specified in the catalog are not the same as the products on the order date. In line with this information, the company is not responsible in any way or form for any errors, material or moral damages that may arise from the information or visual material contained in this catalogue.

The company may make unilateral changes regarding the information or products in the catalog without prior notice. The company reserves the right to change the technical specifications, images or dimensions of its products or products, in whole or in part, at any time. The assembly, connection details, usage areas or safety measures seen in the images in the catalogs do not constitute an example for the correct use of the products. Persons using the products are obliged to comply with the safety warnings regarding the products in the catalog content, as well as the additional safety / usage instructions regarding the products, otherwise the company cannot be held responsible for any damages that may arise.

This Catalog, all its pages, the information and products in it are protected within the scope of the intellectual and industrial rights of the company. The copyright of the product catalog, all the information in its content, images and products belongs to İzeltaş İzmir El Aletleri Sanayi ve Ticaret A.Ş. Unauthorized use, publication, production, distribution and reproduction of the products, information, images or catalog subject to this copyright without the written permission of the company is prohibited, otherwise it will result in violation of the intellectual and industrial rights of the company.

KOD	ÜRÜN	FİYAT	SAYFA
1225060036	1" 12KŞ LKM ANH 36	833,00	117
1225060041	1" 12KŞ LKM ANH 41	906,75	117
1225060046	1" 12KŞ LKM ANH 46	1.099,50	117
1225060050	1" 12KŞ LKM ANH 50	1.302,25	117
1225060055	1" 12KŞ LKM ANH 55	1.667,50	117
1225060060	1" 12KŞ LKM ANH 60	2.167,50	117
14000004462	1" 6KŞ HVL DRN LKM ANH 21	942,25	128
14000004463	1" 6KŞ HVL DRN LKM ANH 22	942,25	128
14000004464	1" 6KŞ HVL DRN LKM ANH 23	942,25	128
14000004465	1" 6KŞ HVL DRN LKM ANH 24	942,25	128
14000004466	1" 6KŞ HVL DRN LKM ANH 25	942,25	128
14000004467	1" 6KŞ HVL DRN LKM ANH 26	942,25	128
14000004468	1" 6KŞ HVL DRN LKM ANH 27	942,25	128
14000004469	1" 6KŞ HVL DRN LKM ANH 28	961,50	128
14000004470	1" 6KŞ HVL DRN LKM ANH 29	961,50	128
14000004471	1" 6KŞ HVL DRN LKM ANH 30	961,50	128
14000004472	1" 6KŞ HVL DRN LKM ANH 32	1.036,50	128
14000004473	1" 6KŞ HVL DRN LKM ANH 33	1.036,50	128
14000004474	1" 6KŞ HVL DRN LKM ANH 34	1.077,00	128
14000004475	1" 6KŞ HVL DRN LKM ANH 35	1.144,25	128
14000004476	1" 6KŞ HVL DRN LKM ANH 36	1.144,25	128
14000004477	1" 6KŞ HVL DRN LKM ANH 38	1.307,75	128
14000004478	1" 6KŞ HVL DRN LKM ANH 41	1.403,75	128
14000004479	1" 6KŞ HVL DRN LKM ANH 46	1.615,50	128
14000004480	1" 6KŞ HVL DRN LKM ANH 50	1.923,00	128
14000004481	1" 6KŞ HVL DRN LKM ANH 55	2.500,00	128
14000004482	1" 6KŞ HVL DRN LKM ANH 60	3.269,25	128
14000004483	1" 6KŞ HVL DRN LKM ANH 65	4.250,00	128
14000004484	1" 6KŞ HVL DRN LKM ANH 70	5.403,75	128
14000004485	1" 6KŞ HVL DRN LKM ANH 75	6.384,50	128
14000004486	1" 6KŞ HVL DRN LKM ANH 80	7.327,00	128
14000004487	1" 6KŞ HVL DRN LKM ANH 85	12.019,25	128
14000004488	1" 6KŞ HVL DRN LKM ANH 90	13.942,25	128
1125067021	1" 6KŞ HVL LKM ANH 21	682,75	128
1125067022	1" 6KŞ HVL LKM ANH 22	682,75	128
1125067023	1" 6KŞ HVL LKM ANH 23	682,75	128
1125067024	1" 6KŞ HVL LKM ANH 24	682,75	128
1125067025	1" 6KŞ HVL LKM ANH 25	682,75	128
1125067026	1" 6KŞ HVL LKM ANH 26	682,75	128
1125067027	1" 6KŞ HVL LKM ANH 27	682,75	128
1125067028	1" 6KŞ HVL LKM ANH 28	682,75	128
1125067029	1" 6KŞ HVL LKM ANH 29	682,75	128
1125067030	1" 6KŞ HVL LKM ANH 30	753,25	128
1125067032	1" 6KŞ HVL LKM ANH 32	762,25	128
1125067033	1" 6KŞ HVL LKM ANH 33	762,25	128
1125067034	1" 6KŞ HVL LKM ANH 34	766,00	128
1125060035	1" 6KŞ HVL LKM ANH 35	768,00	128
1125067036	1" 6KŞ HVL LKM ANH 36	769,50	128
1125067038	1" 6KŞ HVL LKM ANH 38	801,50	128
1125067041	1" 6KŞ HVL LKM ANH 41	976,25	128

KOD	ÜRÜN	FİYAT	SAYFA
1125067046	1" 6KŞ HVL LKM ANH 46	1.077,00	128
1125060048	1" 6KŞ HVL LKM ANH 48	1.148,50	128
1125067050	1" 6KŞ HVL LKM ANH 50	1.148,50	128
1125067055	1" 6KŞ HVL LKM ANH 55	1.522,75	128
1125067060	1" 6KŞ HVL LKM ANH 60	1.903,50	128
1125060065	1" 6KŞ HVL LKM ANH 65	2.115,50	128
1125060070	1" 6KŞ HVL LKM ANH 70	2.788,50	128
1125060075	1" 6KŞ HVL LKM ANH 75	3.750,00	128
1125060080	1" 6KŞ HVL LKM ANH 80	4.327,00	128
1125060085	1" 6KŞ HVL LKM ANH 85	5.769,25	128
1125060090	1" 6KŞ HVL LKM ANH 90	7.019,25	128
1525067175	1" HVL LKM ARA KOL 175	1.846,75	129
1525067250	1" HVL LKM ARA KOL 250	2.373,25	129
1525067330	1" HVL LKM ARA KOL 330	2.885,00	129
1525067128	1" HVL LKM MFSL 128	3.443,50	129
2201100010	1" MŞL BORU ANH 85	839,00	133
2203100010	1" MŞL BORU ANH 85 ELTA	700,00	234
2201100110	1" MŞL BORU ANH YP SMN 85	42,75	242
1525067015	1"FX3/4" HVL LKM ADP	707,00	129
1525060005	1"FX3/4" LKM ADP	536,00	117
14000005130	1/2 TWIST LKM SET10	3.855,75	107
1413061025	1/2" 12KŞ LKM ANH 1 SAE	159,25	107
1413061012	1/2" 12KŞ LKM ANH 1/2 SAE	135,25	107
1114061010	1/2" 12KŞ LKM ANH 10	107,50	107
1114061011	1/2" 12KŞ LKM ANH 11	107,50	107
1413061016	1/2" 12KŞ LKM ANH 11/16 SAE	146,50	107
1413061027	1/2" 12KŞ LKM ANH 1-1/16 SAE	209,00	107
1413061032	1/2" 12KŞ LKM ANH 1-1/4 SAE	209,00	107
1413061029	1/2" 12KŞ LKM ANH 1-1/8 SAE	209,00	107
1114061012	1/2" 12KŞ LKM ANH 12	107,50	107
1114061013	1/2" 12KŞ LKM ANH 13	116,25	107
1413061021	1/2" 12KŞ LKM ANH 13/16 SAE	153,00	107
1413061030	1/2" 12KŞ LKM ANH 1-3/16 SAE	209,00	107
1114061014	1/2" 12KŞ LKM ANH 14	116,25	107
1114061015	1/2" 12KŞ LKM ANH 15	116,25	107
1413061024	1/2" 12KŞ LKM ANH 15/16 SAE	159,25	107
1413061011	1/2" 12KŞ LKM ANH 15/32 SAE	130,00	107
1114061016	1/2" 12KŞ LKM ANH 16	121,00	107
1114061017	1/2" 12KŞ LKM ANH 17	121,00	107
1114061018	1/2" 12KŞ LKM ANH 18	121,00	107
1114061019	1/2" 12KŞ LKM ANH 19	127,00	107
1413061014	1/2" 12KŞ LKM ANH 19/32 SAE	139,75	107
1114061020	1/2" 12KŞ LKM ANH 20	127,00	107
1114061021	1/2" 12KŞ LKM ANH 21	127,00	107
1114061022	1/2" 12KŞ LKM ANH 22	127,00	107
1114061023	1/2" 12KŞ LKM ANH 23	131,75	107
1114061024	1/2" 12KŞ LKM ANH 24	131,75	107
1413061020	1/2" 12KŞ LKM ANH 25/32 SAE	153,00	107
1114061026	1/2" 12KŞ LKM ANH 26	148,50	107
1114061027	1/2" 12KŞ LKM ANH 27	169,75	107



KOD	ÜRÜN	FİYAT	SAYFA	KOD	ÜRÜN	FİYAT	SAYFA
1114061028	1/2" 12KŞ LKM ANH 28	169,75	107	1108067022	1/2" 6KŞ HVL DRN LKM ANH 22	294,50	124
1413061017	1/2" 12KŞ LKM ANH 3/4 SAE	147,75	107	1108067023	1/2" 6KŞ HVL DRN LKM ANH 23	309,00	124
1413061095	1/2" 12KŞ LKM ANH 3/8 SAE	125,50	107	1108067024	1/2" 6KŞ HVL DRN LKM ANH 24	310,75	124
1114061030	1/2" 12KŞ LKM ANH 30	178,00	107	1108067025	1/2" 6KŞ HVL DRN LKM ANH 25	365,50	124
1114061032	1/2" 12KŞ LKM ANH 32	186,75	107	1108067026	1/2" 6KŞ HVL DRN LKM ANH 26	369,25	124
1413061008	1/2" 12KŞ LKM ANH 5/16 SAE	125,50	107	1108067027	1/2" 6KŞ HVL DRN LKM ANH 27	411,25	124
1413061015	1/2" 12KŞ LKM ANH 5/8 SAE	141,50	107	1108067028	1/2" 6KŞ HVL DRN LKM ANH 28	413,50	124
1413061010	1/2" 12KŞ LKM ANH 7/16 SAE	130,00	107	1108067029	1/2" 6KŞ HVL DRN LKM ANH 29	413,50	124
1413061022	1/2" 12KŞ LKM ANH 7/8 SAE	153,00	107	1108067030	1/2" 6KŞ HVL DRN LKM ANH 30	461,00	124
1413061013	1/2" 12KŞ LKM ANH 9/16 SAE	139,75	107	1108067032	1/2" 6KŞ HVL DRN LKM ANH 32	491,25	124
1114006024	1/2" 12KŞ LKM ANH SET24	4.488,25	113	1108067008	1/2" 6KŞ HVL DRN LKM ANH 8	232,00	124
1413006024	1/2" 12KŞ LKM ANH SET24 SAE	4.931,75	113	1108067009	1/2" 6KŞ HVL DRN LKM ANH 9	232,00	124
1114064210	1/2" 12KŞ LKM BİTS XZN M10 140	216,00	110	1113067008	1/2" 6KŞ HVL LKM ANH 08	121,25	124
1114064010	1/2" 12KŞ LKM BİTS XZN M10 60	124,50	110	1113067009	1/2" 6KŞ HVL LKM ANH 09	121,25	124
1114064110	1/2" 12KŞ LKM BİTS XZN M10 80	173,25	110	1113067010	1/2" 6KŞ HVL LKM ANH 10	122,50	124
1114064212	1/2" 12KŞ LKM BİTS XZN M12 140	243,25	110	1113067011	1/2" 6KŞ HVL LKM ANH 11	122,50	124
1114064012	1/2" 12KŞ LKM BİTS XZN M12 60	147,75	110	1113067012	1/2" 6KŞ HVL LKM ANH 12	122,50	124
1114064112	1/2" 12KŞ LKM BİTS XZN M12 80	179,00	110	1113067013	1/2" 6KŞ HVL LKM ANH 13	131,25	124
1114064214	1/2" 12KŞ LKM BİTS XZN M14 140	273,25	110	1113067014	1/2" 6KŞ HVL LKM ANH 14	131,25	124
1114064114	1/2" 12KŞ LKM BİTS XZN M14 80	191,50	110	1113067015	1/2" 6KŞ HVL LKM ANH 15	151,00	124
1114064216	1/2" 12KŞ LKM BİTS XZN M16 140	396,00	110	1113067016	1/2" 6KŞ HVL LKM ANH 16	158,00	124
1114064005	1/2" 12KŞ LKM BİTS XZN M5 60	124,50	110	1113067017	1/2" 6KŞ HVL LKM ANH 17	158,25	124
1114064006	1/2" 12KŞ LKM BİTS XZN M6 60	124,50	110	1113067018	1/2" 6KŞ HVL LKM ANH 18	159,00	124
1114064106	1/2" 12KŞ LKM BİTS XZN M6 80	157,25	110	1113067019	1/2" 6KŞ HVL LKM ANH 19	161,75	124
1114064208	1/2" 12KŞ LKM BİTS XZN M8 140	176,25	110	1113067020	1/2" 6KŞ HVL LKM ANH 20	169,25	124
1114064008	1/2" 12KŞ LKM BİTS XZN M8 60	124,50	110	1113067021	1/2" 6KŞ HVL LKM ANH 21	170,50	124
1114064108	1/2" 12KŞ LKM BİTS XZN M8 80	157,25	110	1113067022	1/2" 6KŞ HVL LKM ANH 22	195,00	124
1108060010	1/2" 6KŞ DRN LKM ANH 10	200,75	108	1113067023	1/2" 6KŞ HVL LKM ANH 23	203,75	124
1108060011	1/2" 6KŞ DRN LKM ANH 11	200,75	108	1113067024	1/2" 6KŞ HVL LKM ANH 24	201,75	124
1108060012	1/2" 6KŞ DRN LKM ANH 12	200,75	108	1113067025	1/2" 6KŞ HVL LKM ANH 25	238,50	124
1108060013	1/2" 6KŞ DRN LKM ANH 13	215,00	108	1113067026	1/2" 6KŞ HVL LKM ANH 26	240,50	124
1108060014	1/2" 6KŞ DRN LKM ANH 14	215,00	108	1113067027	1/2" 6KŞ HVL LKM ANH 27	256,25	124
1108060015	1/2" 6KŞ DRN LKM ANH 15	215,00	108	1113067028	1/2" 6KŞ HVL LKM ANH 28	275,00	124
1108060016	1/2" 6KŞ DRN LKM ANH 16	225,00	108	1113067029	1/2" 6KŞ HVL LKM ANH 29	278,75	124
1108060017	1/2" 6KŞ DRN LKM ANH 17	225,00	108	1113067030	1/2" 6KŞ HVL LKM ANH 30	300,00	124
1108060018	1/2" 6KŞ DRN LKM ANH 18	225,00	108	1113067032	1/2" 6KŞ HVL LKM ANH 32	327,00	124
1108060019	1/2" 6KŞ DRN LKM ANH 19	235,50	108	1113009003	1/2" 6KŞ JNT LKM ANH TK3	1.403,00	123
1108006010	1/2" 6KŞ DRN LKM TK10	2.157,75	108	1113061008	1/2" 6KŞ LKM ANH 08	86,25	106
1108067010	1/2" 6KŞ HVL DRN LKM ANH 10	233,00	124	1113061009	1/2" 6KŞ LKM ANH 09	86,25	106
1108067011	1/2" 6KŞ HVL DRN LKM ANH 11	233,00	124	1113061010	1/2" 6KŞ LKM ANH 10	107,25	106
1108067012	1/2" 6KŞ HVL DRN LKM ANH 12	233,00	124	1115060010	1/2" 6KŞ LKM ANH 10 ELTA	87,25	232
1108067013	1/2" 6KŞ HVL DRN LKM ANH 13	252,75	124	1113061011	1/2" 6KŞ LKM ANH 11	107,25	106
1108067014	1/2" 6KŞ HVL DRN LKM ANH 14	252,75	124	1115060011	1/2" 6KŞ LKM ANH 11 ELTA	87,25	232
1108067015	1/2" 6KŞ HVL DRN LKM ANH 15	282,00	124	1113061012	1/2" 6KŞ LKM ANH 12	107,25	106
1108067016	1/2" 6KŞ HVL DRN LKM ANH 16	282,00	124	1115060012	1/2" 6KŞ LKM ANH 12 ELTA	87,25	232
1108067017	1/2" 6KŞ HVL DRN LKM ANH 17	282,00	124	1113061013	1/2" 6KŞ LKM ANH 13	115,25	106
1108067018	1/2" 6KŞ HVL DRN LKM ANH 18	282,00	124	1115060013	1/2" 6KŞ LKM ANH 13 ELTA	90,75	232
1108067019	1/2" 6KŞ HVL DRN LKM ANH 19	282,00	124	1113061014	1/2" 6KŞ LKM ANH 14	115,25	106
1108067020	1/2" 6KŞ HVL DRN LKM ANH 20	293,00	124	1115060014	1/2" 6KŞ LKM ANH 14 ELTA	90,75	232
1108067021	1/2" 6KŞ HVL DRN LKM ANH 21	294,50	124	1113061015	1/2" 6KŞ LKM ANH 15	115,25	106

KOD	ÜRÜN	FİYAT	SAYFA	KOD	ÜRÜN	FİYAT	SAYFA
1115060015	1/2" 6KŞ LKM ANH 15 ELTA	90,75	232	1113064117	1/2" ALLEN UÇ LKM ANH 17 100	302,00	109
1113061016	1/2" 6KŞ LKM ANH 16	120,75	106	1113001107	1/2" ALLEN UÇ LKM ANH TK7	1.020,25	109
1115060016	1/2" 6KŞ LKM ANH 16 ELTA	94,25	232	1113006017	1/2" ALLEN UÇ&TORX UÇ LKM ANH SET17	3.047,50	110
1113061017	1/2" 6KŞ LKM ANH 17	120,75	106	1513064125	1/2" ARA KOL 125	226,00	111
1115060017	1/2" 6KŞ LKM ANH 17 ELTA	94,25	232	1514064125	1/2" ARA KOL 125 ELTA	175,25	232
1113061018	1/2" 6KŞ LKM ANH 18	120,75	106	1513064250	1/2" ARA KOL 250	343,00	111
1115060018	1/2" 6KŞ LKM ANH 18 ELTA	94,25	232	1514064250	1/2" ARA KOL 250 ELTA	303,50	232
1113061019	1/2" 6KŞ LKM ANH 19	126,00	106	1513064075	1/2" ARA KOL 75	202,00	111
1115060019	1/2" 6KŞ LKM ANH 19 ELTA	101,25	232	1113065010	1/2" BITS TUTC LKM	120,75	111
1113061020	1/2" 6KŞ LKM ANH 20	126,00	106	1113069160	1/2" BUJİ LKM LSTK 16	154,75	106
1115060020	1/2" 6KŞ LKM ANH 20 ELTA	101,25	232	1113069208	1/2" BUJİ LKM LSTK 20,8	199,50	106
1113061021	1/2" 6KŞ LKM ANH 21	126,00	106	1514065250	1/2" CRC KOL 250 ELTA	710,75	233
1115060021	1/2" 6KŞ LKM ANH 21 ELTA	101,25	232	1513060032	1/2" CRC KOL 32DİŞ 250	891,00	110
1113061022	1/2" 6KŞ LKM ANH 22	126,00	106	1613064020	1/2" CRC TORK ANH 40-200NM	7.729,50	119
1115060022	1/2" 6KŞ LKM ANH 22 ELTA	101,25	232	1613066034	1/2" CRC TORK ANH 60-340NM	8.103,75	119
1113061023	1/2" 6KŞ LKM ANH 23	131,25	106	14000004550	1/2" HVL ALLEN UÇ LKM ANH H10	336,50	125
1115060023	1/2" 6KŞ LKM ANH 23 ELTA	110,25	232	14000004551	1/2" HVL ALLEN UÇ LKM ANH H12	336,50	125
1113061024	1/2" 6KŞ LKM ANH 24	131,25	106	14000004552	1/2" HVL ALLEN UÇ LKM ANH H14	336,50	125
1115060024	1/2" 6KŞ LKM ANH 24 ELTA	110,25	232	14000004553	1/2" HVL ALLEN UÇ LKM ANH H17	355,75	125
1113061025	1/2" 6KŞ LKM ANH 25	131,25	106	14000004554	1/2" HVL ALLEN UÇ LKM ANH H19	423,00	125
1113061026	1/2" 6KŞ LKM ANH 26	131,25	106	14000004546	1/2" HVL ALLEN UÇ LKM ANH H4	307,75	125
1115060026	1/2" 6KŞ LKM ANH 26 ELTA	123,50	232	14000004547	1/2" HVL ALLEN UÇ LKM ANH H5	307,75	125
1113061027	1/2" 6KŞ LKM ANH 27	150,25	106	14000004548	1/2" HVL ALLEN UÇ LKM ANH H6	307,75	125
1115060027	1/2" 6KŞ LKM ANH 27 ELTA	140,50	232	14000004549	1/2" HVL ALLEN UÇ LKM ANH H8	336,50	125
1113061028	1/2" 6KŞ LKM ANH 28	150,25	106	1513067125	1/2" HVL LKM ARA KOL 125	464,50	125
1115060028	1/2" 6KŞ LKM ANH 28 ELTA	147,75	232	1513067075	1/2" HVL LKM MFSL 75	589,50	125
1113061029	1/2" 6KŞ LKM ANH 29	158,25	106	14000004539	1/2" HVL TORX LKM ANH E10	240,50	124
1113061030	1/2" 6KŞ LKM ANH 30	158,25	106	14000005160	1/2" HVL TORX LKM ANH E12	240,50	124
1115060030	1/2" 6KŞ LKM ANH 30 ELTA	147,75	232	14000004540	1/2" HVL TORX LKM ANH E14	240,50	124
1113061032	1/2" 6KŞ LKM ANH 32	164,75	106	14000004541	1/2" HVL TORX LKM ANH E16	240,50	124
1115060032	1/2" 6KŞ LKM ANH 32 ELTA	158,25	232	14000004542	1/2" HVL TORX LKM ANH E18	269,25	124
1113002017	1/2" 6KŞ LKM ANH SET17	3.375,50	113	14000004543	1/2" HVL TORX LKM ANH E20	288,50	124
1115002017	1/2" 6KŞ LKM ANH SET17 ELTA	2.826,25	233	14000004544	1/2" HVL TORX LKM ANH E22	313,50	124
1113002024	1/2" 6KŞ LKM ANH SET24	4.381,75	113	14000004545	1/2" HVL TORX LKM ANH E24	327,00	124
1115002024	1/2" 6KŞ LKM ANH SET24 ELTA	3.672,75	233	14000004573	1/2" HVL TORX UÇ LKM ANH T20	355,75	125
1975091322	1/2" ADP BJJ ANH İSTV	653,50	118	14000004574	1/2" HVL TORX UÇ LKM ANH T25	355,75	125
1113064105	1/2" ALLEN UÇ LKM ANH 05 100	162,50	109	14000004575	1/2" HVL TORX UÇ LKM ANH T27	355,75	125
1113061105	1/2" ALLEN UÇ LKM ANH 05 60	137,50	109	14000004576	1/2" HVL TORX UÇ LKM ANH T30	355,75	125
1113064106	1/2" ALLEN UÇ LKM ANH 06 100	162,50	109	14000004577	1/2" HVL TORX UÇ LKM ANH T40	355,75	125
1113061106	1/2" ALLEN UÇ LKM ANH 06 60	137,50	109	14000004578	1/2" HVL TORX UÇ LKM ANH T45	365,50	125
1113064107	1/2" ALLEN UÇ LKM ANH 07 100	162,50	109	14000004579	1/2" HVL TORX UÇ LKM ANH T50	375,00	125
1113061107	1/2" ALLEN UÇ LKM ANH 07 60	137,50	109	14000004580	1/2" HVL TORX UÇ LKM ANH T55	375,00	125
1113064108	1/2" ALLEN UÇ LKM ANH 08 100	162,50	109	14000004581	1/2" HVL TORX UÇ LKM ANH T60	375,00	125
1113061108	1/2" ALLEN UÇ LKM ANH 08 60	137,50	109	14000004582	1/2" HVL TORX UÇ LKM ANH T80	423,00	125
1113064110	1/2" ALLEN UÇ LKM ANH 10 100	187,75	109	1113316100	1/2" LKM ANH SHP	2.228,75	248
1113061110	1/2" ALLEN UÇ LKM ANH 10 60	156,75	109	1113006145	1/2" LKM ANH&SHP SET146	20.132,50	106
1113064112	1/2" ALLEN UÇ LKM ANH 12 100	187,75	109	1114065010	1/2" LKM BITS UÇ RİBE M10	172,75	110
1113061112	1/2" ALLEN UÇ LKM ANH 12 60	156,75	109	1114065011	1/2" LKM BITS UÇ RİBE M10,5	176,75	110
1113064114	1/2" ALLEN UÇ LKM ANH 14 100	226,00	109	1114065012	1/2" LKM BITS UÇ RİBE M12	220,00	110
1113061114	1/2" ALLEN UÇ LKM ANH 14 60	156,75	109	1114065013	1/2" LKM BITS UÇ RİBE M13	241,25	110



KOD	ÜRÜN	FİYAT	SAYFA	KOD	ÜRÜN	FİYAT	SAYFA
1114065014	1/2" LKM BİTS UÇ RİBE M14	241,25	110	1107064004	1/4" 6KŞ DRN LKM ANH 04	50,50	97
1114065016	1/2" LKM BİTS UÇ RİBE M16	326,50	110	1107064005	1/4" 6KŞ DRN LKM ANH 05	50,50	97
1114065004	1/2" LKM BİTS UÇ RİBE M4	171,00	110	1107064006	1/4" 6KŞ DRN LKM ANH 06	57,00	97
1114065005	1/2" LKM BİTS UÇ RİBE M5	171,00	110	1107064007	1/4" 6KŞ DRN LKM ANH 07	57,00	97
1114065006	1/2" LKM BİTS UÇ RİBE M6	171,00	110	1107064008	1/4" 6KŞ DRN LKM ANH 08	57,00	97
1114065007	1/2" LKM BİTS UÇ RİBE M7	171,00	110	1107064009	1/4" 6KŞ DRN LKM ANH 09	61,00	97
1114065008	1/2" LKM BİTS UÇ RİBE M8	171,00	110	1107064010	1/4" 6KŞ DRN LKM ANH 10	61,00	97
1114065009	1/2" LKM BİTS UÇ RİBE M9	172,75	110	1107064011	1/4" 6KŞ DRN LKM ANH 11	65,50	97
1514064065	1/2" MFSL 65 ELTA	233,00	232	1107064012	1/4" 6KŞ DRN LKM ANH 12	65,50	97
1513064070	1/2" MFSL 70	286,50	111	1107064013	1/4" 6KŞ DRN LKM ANH 13	65,50	97
1840080500	1/2" MFSL T KOL 500	1.334,25	118	1107064055	1/4" 6KŞ DRN LKM ANH 5,5	50,50	97
1513062250	1/2" T KOL 250	493,00	111	1107006014	1/4" 6KŞ DRN LKM ANH SET14	1.252,00	97
1514064025	1/2" T KOL 250 ELTA	333,75	232	1107060004	1/4" 6KŞ LKM ANH 04	26,25	97
1513065250	1/2" T KOL LKM ADP	210,25	111	1107060005	1/4" 6KŞ LKM ANH 05	26,25	97
1514066250	1/2" T KOL LKM ADP ELTA	191,50	232	1107060006	1/4" 6KŞ LKM ANH 06	26,25	97
1613061200	1/2" TORX ANH 25-135NM	7.883,25	119	1107060007	1/4" 6KŞ LKM ANH 07	26,25	97
1613062000	1/2" TORX ANH 50-225NM	8.136,75	119	1107060008	1/4" 6KŞ LKM ANH 08	26,25	97
1613063000	1/2" TORX ANH 70-330NM	9.901,00	119	1107060009	1/4" 6KŞ LKM ANH 09	28,50	97
1113060210	1/2" TORX LKM ANH E10	103,25	108	1107060010	1/4" 6KŞ LKM ANH 10	28,50	97
1113060212	1/2" TORX LKM ANH E12	103,25	108	1107060011	1/4" 6KŞ LKM ANH 11	36,00	97
1113060214	1/2" TORX LKM ANH E14	103,25	108	1107060012	1/4" 6KŞ LKM ANH 12	36,00	97
1113060216	1/2" TORX LKM ANH E16	103,25	108	1107060013	1/4" 6KŞ LKM ANH 13	41,25	97
1113060218	1/2" TORX LKM ANH E18	103,25	108	1107060045	1/4" 6KŞ LKM ANH 4,5	26,25	97
1113060220	1/2" TORX LKM ANH E20	116,25	108	1107060055	1/4" 6KŞ LKM ANH 5,5	26,25	97
1113006007	1/2" TORX LKM ANH SET7	858,50	108	1107006015	1/4" 6KŞ LKM ANH SET15	1.153,00	101
1113064220	1/2" TORX UÇ LKM ANH T20 100	191,50	109	14000005131	1/4" 6KŞ LKM ANH&BİTS SET48	3.067,25	102
1113061220	1/2" TORX UÇ LKM ANH T20 60	169,25	109	1107061103	1/4" ALLEN UÇ LKM ANH 03	44,50	98
1113064225	1/2" TORX UÇ LKM ANH T25 100	191,50	109	1107061104	1/4" ALLEN UÇ LKM ANH 04	44,50	98
1113061225	1/2" TORX UÇ LKM ANH T25 60	169,25	109	1107061105	1/4" ALLEN UÇ LKM ANH 05	44,50	98
1113064227	1/2" TORX UÇ LKM ANH T27 100	191,50	109	1107061106	1/4" ALLEN UÇ LKM ANH 06	44,50	98
1113061227	1/2" TORX UÇ LKM ANH T27 60	169,25	109	1107061107	1/4" ALLEN UÇ LKM ANH 07	52,50	98
1113064230	1/2" TORX UÇ LKM ANH T30 100	191,50	109	1107061108	1/4" ALLEN UÇ LKM ANH 08	52,50	98
1113061230	1/2" TORX UÇ LKM ANH T30 60	169,25	109	1107061110	1/4" ALLEN UÇ LKM ANH 10	63,00	98
1113064240	1/2" TORX UÇ LKM ANH T40 100	191,50	109	1107061125	1/4" ALLEN UÇ LKM ANH 2,5	44,50	98
1113061240	1/2" TORX UÇ LKM ANH T40 60	169,25	109	1507060100	1/4" ARA KOL 100	71,75	99
1113064245	1/2" TORX UÇ LKM ANH T45 100	191,50	109	1507060050	1/4" ARA KOL 50	66,50	99
1113061245	1/2" TORX UÇ LKM ANH T45 60	169,25	109	1507063150	1/4" ARA KOL FLEX 150	292,00	99
1113064250	1/2" TORX UÇ LKM ANH T50 100	191,50	109	1107065010	1/4" BİTS TUTC LKM MIKN	98,00	101
1113061250	1/2" TORX UÇ LKM ANH T50 60	169,25	109	4784196346	1/4" BİTS TUTC TRNV AVUÇ İÇİ	575,00	178
1113064255	1/2" TORX UÇ LKM ANH T55 100	191,50	109	1107001042	1/4" BİTS UÇ LKM ANH SET42	2.591,50	99
1113061255	1/2" TORX UÇ LKM ANH T55 60	169,25	109	1507062140	1/4" CRC KOL 140	472,75	100
1113064260	1/2" TORX UÇ LKM ANH T60 100	198,50	109	1507062110	1/4" CRC KOL 72DİŞ LKM&BİTS TUTC 110	984,25	100
1113061260	1/2" TORX UÇ LKM ANH T60 60	180,25	109	14000005079	1/4" CRC LKM ANH&BİTS SET23 ELTA	2.307,75	231
1113006009	1/2" TORX UÇ LKM ANH TK9	1.534,25	109	14000005078	1/4" CRC LKM ANH&BİTS SET38 ELTA	2.307,75	231
1513067003	1/2" FX3/4" M HVL LKM ADP	350,75	125	1607060420	1/4" CRC TORX ANH 4-20NM	5.844,75	119
1513060003	1/2" FX3/4" M LKM ADP	166,00	111	1107061310	1/4" DLK TORX UÇ LKM ANH TR10	53,75	98
1513067002	1/2" FX3/8" M HVL LKM ADP	307,25	125	1107061315	1/4" DLK TORX UÇ LKM ANH TR15	53,75	98
1513060002	1/2" FX3/8" M LKM ADP	105,75	111	1107061320	1/4" DLK TORX UÇ LKM ANH TR20	53,75	98
14000005132	1/4" 6 KŞ LKM ANH&BİTS SET27	1.336,50	102	1107061325	1/4" DLK TORX UÇ LKM ANH TR25	53,75	98
14000005133	1/4" 6 KŞ LKM ANH&BİTS SET45	1.961,50	102	1107061327	1/4" DLK TORX UÇ LKM ANH TR27	53,75	98

KOD	ÜRÜN	FİYAT	SAYFA	KOD	ÜRÜN	FİYAT	SAYFA
1107061330	1/4" DLK TORX UÇ LKM ANH TR30	53,75	98	13000005262	1000V 1/2" ARA KOL 75	1.150,75	111
1107061340	1/4" DLK TORX UÇ LKM ANH TR40	62,25	98	13000005277	1000V 1/2" CRC KOL 36DİŞ	4.341,75	110
1107061308	1/4" DLK TORX UÇ LKM ANH TR8	53,75	98	13000005541	1000V 1/2" T KOL	1.057,75	111
1107061309	1/4" DLK TORX UÇ LKM ANH TR9	53,75	98	3715166165	1000V 1A KBLO KSC	707,25	145
1507064080	1/4" DRN LKM TRNV ADP	140,75	101	13000005519	1000V ÇOK FONK ELKT PNS YAY 200	1.730,75	136
1107061403	1/4" DÜZ UÇ LKM ANH 03	44,50	98	3220136140	1000V DÜZ UÇ KRGB 140	629,50	138
1107061404	1/4" DÜZ UÇ LKM ANH 04	44,50	98	3220136160	1000V DÜZ UÇ KRGB 160	695,75	138
1107061407	1/4" DÜZ UÇ LKM ANH 07	44,50	98	3220136180	1000V DÜZ UÇ KRGB 180	781,00	138
1107061408	1/4" DÜZ UÇ LKM ANH 08	57,75	98	3220136200	1000V DÜZ UÇ KRGB 200	811,25	138
1107061410	1/4" DÜZ UÇ LKM ANH 10	62,25	98	4140172575	1000V DÜZ UÇ TRNV 2,5X75	101,25	167
1107061435	1/4" DÜZ UÇ LKM ANH 3,5	44,50	98	4140174100	1000V DÜZ UÇ TRNV 4X100	118,50	167
1107061445	1/4" DÜZ UÇ LKM ANH 4,5	44,50	98	4140175512	1000V DÜZ UÇ TRNV 5,5X125	156,50	167
1107061455	1/4" DÜZ UÇ LKM ANH 5,5	44,50	98	4140176515	1000V DÜZ UÇ TRNV 6,5X150	174,50	167
1107061465	1/4" DÜZ UÇ LKM ANH 6,5	44,50	98	4140009106	1000V DÜZ&YLD UÇ TRNV SET6	873,75	167
1507066140	1/4" MAND CRC KOL 140	676,75	100	3020006003	1000V ELKT 160 SET3	2.111,25	159
1507060038	1/4" MFSL	121,50	99	8795006005	1000V ELKT SET5	2.601,75	159
1507062150	1/4" MFSL CRC KOL 72DİŞ 150	1.568,00	100	0375350026	1000V İZOLELİ MKNK KBLO SYRC	1.182,75	195
1507067115	1/4" MFSL T CRC KOL 72DİŞ 115	1.506,50	100	3020126160	1000V KMB PNS 160	614,75	137
1507064115	1/4" T KOL	119,00	99	3020126180	1000V KMB PNS 180	658,75	137
1107061210	1/4" TORX UÇ LKM ANH T10	46,00	98	3020126200	1000V KMB PNS 200	743,00	137
1107061215	1/4" TORX UÇ LKM ANH T15	46,00	98	0600010010	1000V KURB 10"	1.077,00	89
1107061220	1/4" TORX UÇ LKM ANH T20	46,00	98	4773190040	1000V LKM UÇ TRNV 04	328,25	172
1107061225	1/4" TORX UÇ LKM ANH T25	46,00	98	4773190050	1000V LKM UÇ TRNV 05	328,25	172
1107061227	1/4" TORX UÇ LKM ANH T27	46,00	98	4773190060	1000V LKM UÇ TRNV 06	328,25	172
1107061230	1/4" TORX UÇ LKM ANH T30	46,00	98	4773190070	1000V LKM UÇ TRNV 07	351,75	172
1107061240	1/4" TORX UÇ LKM ANH T40	46,00	98	4773190080	1000V LKM UÇ TRNV 08	351,75	172
1107061208	1/4" TORX UÇ LKM ANH T8	46,00	98	4773190090	1000V LKM UÇ TRNV 09	380,00	172
1107061209	1/4" TORX UÇ LKM ANH T9	46,00	98	4773190100	1000V LKM UÇ TRNV 10	380,00	172
1107061501	1/4" YLD UÇ LKM ANH PH1	44,50	99	4773190110	1000V LKM UÇ TRNV 11	414,75	172
1107061502	1/4" YLD UÇ LKM ANH PH2	44,50	99	4773190120	1000V LKM UÇ TRNV 12	445,00	172
1107061503	1/4" YLD UÇ LKM ANH PH3	44,50	99	4773190130	1000V LKM UÇ TRNV 13	479,25	172
1107061504	1/4" YLD UÇ LKM ANH PH4	44,50	99	4773190140	1000V LKM UÇ TRNV 14	530,00	172
1113001038	1/4"&1/2" 6KŞ LKM ANH SET35	4.811,50	112	4773190055	1000V LKM UÇ TRNV 5,5	328,25	172
1507060004	1/4" FX3/8" M LKM ADP	61,25	101	4773008108	1000V LKM UÇ TRNV TK8	3.130,75	172
4805205011	1/4" M-1/2" M BİTS UÇ LKM ADP	104,00	174	4783196120	1000V MNY BİTS TUTC TRNV 6,3X120	369,25	173
4805205010	1/4" M-1/4" M BİTS UÇ LKM ADP	51,50	174	2400116240	1000V ÜNV FORT PNS 240	833,75	134
13000005148	1000V 1/2" 6KŞ LKM ANH 10	449,50	106	4145180360	1000V YLD UÇ TRNV 3X60	105,00	167
13000005149	1000V 1/2" 6KŞ LKM ANH 11	447,00	106	4145184580	1000V YLD UÇ TRNV 4,5X80	148,50	167
13000005150	1000V 1/2" 6KŞ LKM ANH 12	455,00	106	4145186100	1000V YLD UÇ TRNV 6X100	174,50	167
13000005151	1000V 1/2" 6KŞ LKM ANH 13	457,00	106	3700166140	1000V YNKSK 140	705,50	140
13000005152	1000V 1/2" 6KŞ LKM ANH 14	460,50	106	3700166160	1000V YNKSK 160	800,75	140
13000005153	1000V 1/2" 6KŞ LKM ANH 15	463,00	106	3700166180	1000V YNKSK 180	895,75	140
13000005154	1000V 1/2" 6KŞ LKM ANH 16	472,00	106	2201100015	1-1/2" MŞL BORU ANH 85	1.299,50	133
13000005155	1000V 1/2" 6KŞ LKM ANH 17	478,00	106	2203100015	1-1/2" MŞL BORU ANH 85 ELTA	1.098,50	234
13000005156	1000V 1/2" 6KŞ LKM ANH 19	488,25	106	2201100115	1-1/2" MŞL BORU ANH YP SMN 85	54,25	242
13000005157	1000V 1/2" 6KŞ LKM ANH 22	500,25	106	3715160165	1A KBLO KSC	600,25	145
13000005158	1000V 1/2" 6KŞ LKM ANH 24	510,50	106	1841070021	1A KVN ANH&MİL 21 SET2	206,25	117
13000005159	1000V 1/2" 6KŞ LKM ANH 27	602,00	106	0255010010	1A SPR İZL ANH 10	213,75	76
13000005263	1000V 1/2" ARA KOL 125	1.275,50	111	0255010011	1A SPR İZL ANH 11	226,00	76
13000005264	1000V 1/2" ARA KOL 250	1.732,50	111	0255010012	1A SPR İZL ANH 12	236,50	76



KOD	ÜRÜN	FİYAT	SAYFA	KOD	ÜRÜN	FİYAT	SAYFA
0255010013	1A SPR İZL ANH 13	254,25	76	0100011113	2A ANH KB 1113		73
0255010014	1A SPR İZL ANH 14	263,50	76	0100011114	2A ANH KB 1114		73
0255010017	1A SPR İZL ANH 17	323,25	76	0100011213	2A ANH KB 1213	77,25	73
0255010019	1A SPR İZL ANH 19	379,50	76	0100011214	2A ANH KB 1214	77,25	73
0255010022	1A SPR İZL ANH 22	510,25	76	0100011314	2A ANH KB 1314	77,25	73
0255010024	1A SPR İZL ANH 24	624,50	76	0100011315	2A ANH KB 1315		73
0435030010	1A SPR İZL YLD ANH SB 10	285,00	87	0100011317	2A ANH KB 1317	101,25	73
0435030011	1A SPR İZL YLD ANH SB 11	285,00	87	0100011415	2A ANH KB 1415	89,00	73
0435030012	1A SPR İZL YLD ANH SB 12	323,25	87	0100011417	2A ANH KB 1417	104,00	73
0435030013	1A SPR İZL YLD ANH SB 13	323,25	87	0100011617	2A ANH KB 1617	104,00	73
0435030014	1A SPR İZL YLD ANH SB 14	339,75	87	0100011719	2A ANH KB 1719	111,75	73
0435030017	1A SPR İZL YLD ANH SB 17	384,50	87	0100011722	2A ANH KB 1722		73
0435030019	1A SPR İZL YLD ANH SB 19	458,75	87	0100011819	2A ANH KB 1819	111,75	73
0435030022	1A SPR İZL YLD ANH SB 22	502,50	87	0100011820	2A ANH KB 1820		73
0435030024	1A SPR İZL YLD ANH SB 24	671,50	87	0100011822	2A ANH KB 1822		73
0250010021	1A TAÇ ANH 21		76	0100011922	2A ANH KB 1922	125,50	73
0250010022	1A TAÇ ANH 22		76	0100011924	2A ANH KB 1924		73
0250010023	1A TAÇ ANH 23		76	0100012022	2A ANH KB 2022	130,00	73
0250010024	1A TAÇ ANH 24		76	0100012123	2A ANH KB 2123	136,25	73
0250010025	1A TAÇ ANH 25		76	0100012224	2A ANH KB 2224	142,25	73
0250010027	1A TAÇ ANH 27		76	0100012226	2A ANH KB 2226		73
0250010030	1A TAÇ ANH 30	365,75	76	0100012227	2A ANH KB 2227		73
0250010032	1A TAÇ ANH 32		76	0100012426	2A ANH KB 2426	146,50	73
0250010034	1A TAÇ ANH 34		76	0100012427	2A ANH KB 2427	146,50	73
0250010036	1A TAÇ ANH 36	461,50	76	0100012430	2A ANH KB 2430		73
0250010038	1A TAÇ ANH 38		76	0100012528	2A ANH KB 2528	181,50	73
0250010041	1A TAÇ ANH 41	602,00	76	0100012730	2A ANH KB 2730		73
0250010046	1A TAÇ ANH 46	648,25	76	0100012732	2A ANH KB 2732	216,50	73
0250010050	1A TAÇ ANH 50	809,50	76	0100013032	2A ANH KB 3032	216,50	73
0250010055	1A TAÇ ANH 55	1.084,00	76	0100002112	2A ANH KB TK12	1.390,50	73
0250010060	1A TAÇ ANH 60	1.388,00	76	0100002108	2A ANH KB TK8	709,75	73
0250010065	1A TAÇ ANH 65	1.691,75	76	0150010607	2A ANH SB 0607 ELTA	53,00	228
0250010070	1A TAÇ ANH 70		76	0150010809	2A ANH SB 0809 ELTA	54,00	228
0250010075	1A TAÇ ANH 75		76	0150011011	2A ANH SB 1011 ELTA	58,50	228
2201100020	2" MŞL BORU ANH 85	1.945,50	133	0150011213	2A ANH SB 1213 ELTA	64,50	228
2203100020	2" MŞL BORU ANH 85 ELTA	1.637,50	234	0150011415	2A ANH SB 1415 ELTA	74,75	228
2201100120	2" MŞL BORU ANH YP SMN 85	71,75	242	0150011617	2A ANH SB 1617 ELTA	86,25	228
0100010405	2A ANH KB 0405	61,25	73	0150011819	2A ANH SB 1819 ELTA	92,50	228
0100010607	2A ANH KB 0607	63,00	73	0150012022	2A ANH SB 2022 ELTA	105,00	228
0100010608	2A ANH KB 0608		73	0150012123	2A ANH SB 2123 ELTA	114,50	228
0100010708	2A ANH KB 0708		73	0150012426	2A ANH SB 2426 ELTA	131,50	228
0100010709	2A ANH KB 0709		73	0150012528	2A ANH SB 2528 ELTA	158,00	228
0100010809	2A ANH KB 0809	64,50	73	0150012732	2A ANH SB 2732 ELTA	188,00	228
0100010810	2A ANH KB 0810	71,00	73	0150002112	2A ANH SB TK12 ELTA	1.180,50	228
0100010910	2A ANH KB 0910		73	0150002108	2A ANH SB TK8 ELTA	588,50	228
0100010911	2A ANH KB 0911		73	8001316012	2A ANH SHP	343,00	249
0100011011	2A ANH KB 1011	70,25	73	0130010555	2A ANH UB 05X5,5		74
0100011012	2A ANH KB 1012	70,25	73	0130010607	2A ANH UB 0607	79,75	74
0100011013	2A ANH KB 1013	75,25	73	0130010608	2A ANH UB 0608	82,75	74
0100011014	2A ANH KB 1014		73	0130010708	2A ANH UB 0708		74

KOD	ÜRÜN	FİYAT	SAYFA	KOD	ÜRÜN	FİYAT	SAYFA
0130010709	2A ANH UB 0709		74	0161010911	2A ANH UB 3/8X7/16 SAE	109,50	75
0130010809	2A ANH UB 0809	82,75	74	0130013032	2A ANH UB 3032	264,50	74
0130010810	2A ANH UB 0810	82,75	74	0130013036	2A ANH UB 3036	501,50	74
0130010910	2A ANH UB 0910		74	0130013236	2A ANH UB 3236	501,50	74
0130010911	2A ANH UB 0911		74	0130013436	2A ANH UB 3436	501,50	74
0161011214	2A ANH UB 1/2X9/16 SAE	115,25	75	0130013641	2A ANH UB 3641	778,75	74
0161010608	2A ANH UB 1/4X5/16 SAE	98,75	75	0130014146	2A ANH UB 4146	1.200,75	74
0130011011	2A ANH UB 1011	91,25	74	0130014650	2A ANH UB 4650	1.331,50	74
0130011012	2A ANH UB 1012	91,25	74	0161010810	2A ANH UB 5/16X11/32 SAE	98,75	75
0130011013	2A ANH UB 1013	91,25	74	0161010809	2A ANH UB 5/16X3/8 SAE	98,75	75
0130011014	2A ANH UB 1014	91,25	74	0161010811	2A ANH UB 5/16X7/16 SAE	98,75	75
0161012631	2A ANH UB 1-1/16X1-1/4 SAE	337,25	75	0161011619	2A ANH UB 5/8X3/4 SAE	158,00	75
0161012628	2A ANH UB 1-1/16X1-1/8 SAE	319,50	75	0161011112	2A ANH UB 7/16X1/2 SAE	109,50	75
0161012833	2A ANH UB 1-1/8X1-5/16 SAE	337,25	75	0161011417	2A ANH UB 9/16X11/16 SAE	145,75	75
0130011113	2A ANH UB 1113	91,25	74	0161011416	2A ANH UB 9/16X5/8 SAE	134,00	75
0130011114	2A ANH UB 1114	91,25	74	0130002112	2A ANH UB TK12	1.691,75	74
0130011213	2A ANH UB 1213	96,00	74	0161002112	2A ANH UB TK12 SAE	2.052,50	75
0130011214	2A ANH UB 1214	96,00	74	0130002108	2A ANH UB TK8	869,25	74
0161012122	2A ANH UB 13/16X7/8 SAE	186,75	75	0161002108	2A ANH UB TK8 SAE	1.153,25	75
0130011314	2A ANH UB 1314	96,00	74	0440030607	2A DÜZ YLD ANH SB 0607	131,50	86
0130011315	2A ANH UB 1315	96,00	74	0440030809	2A DÜZ YLD ANH SB 0809	137,50	86
0130011317	2A ANH UB 1317	122,00	74	0440030810	2A DÜZ YLD ANH SB 0810		86
0130011415	2A ANH UB 1415	111,75	74	0440031011	2A DÜZ YLD ANH SB 1011	152,25	86
0130011417	2A ANH UB 1417	122,00	74	0440031013	2A DÜZ YLD ANH SB 1013		86
0161012325	2A ANH UB 15/16X1 SAE	220,00	75	0440031213	2A DÜZ YLD ANH SB 1213	164,25	86
0161012328	2A ANH UB 15/16X1-1/8 SAE	222,50	75	0440031315	2A DÜZ YLD ANH SB 1315		86
0130011617	2A ANH UB 1617	123,25	74	0440031317	2A DÜZ YLD ANH SB 1317		86
0130011618	2A ANH UB 1618	131,50	74	0440031415	2A DÜZ YLD ANH SB 1415	191,25	86
0130011719	2A ANH UB 1719	131,50	74	0440031617	2A DÜZ YLD ANH SB 1617	226,25	86
0130011722	2A ANH UB 1722		74	0440031618	2A DÜZ YLD ANH SB 1618		86
0130011724	2A ANH UB 1724		74	0440031719	2A DÜZ YLD ANH SB 1719		86
0130011819	2A ANH UB 1819	131,50	74	0440031819	2A DÜZ YLD ANH SB 1819	236,75	86
0161011517	2A ANH UB 19/32X11/16 SAE	147,50	75	0440032022	2A DÜZ YLD ANH SB 2022	275,00	86
0130011921	2A ANH UB 1921	153,00	74	0440032123	2A DÜZ YLD ANH SB 2123	325,75	86
0130011922	2A ANH UB 1922	153,00	74	0440032224	2A DÜZ YLD ANH SB 2224		86
0130011924	2A ANH UB 1924	153,75	74	0440032426	2A DÜZ YLD ANH SB 2426	330,00	86
0130012022	2A ANH UB 2022	153,00	74	0440032427	2A DÜZ YLD ANH SB 2427		86
0130012123	2A ANH UB 2123	156,50	74	0440032528	2A DÜZ YLD ANH SB 2528	384,75	86
0130012224	2A ANH UB 2224	166,00	74	0440032729	2A DÜZ YLD ANH SB 2729		86
0130012227	2A ANH UB 2227		74	0440032732	2A DÜZ YLD ANH SB 2732	475,50	86
0130012426	2A ANH UB 2426	189,50	74	0440033032	2A DÜZ YLD ANH SB 3032		86
0130012427	2A ANH UB 2427	189,50	74	0440002112	2A DÜZ YLD ANH SB TK12	3.030,75	86
0130012430	2A ANH UB 2430	212,00	74	0440002108	2A DÜZ YLD ANH SB TK8	1.514,75	86
0161012021	2A ANH UB 25/32X13/16 SAE	183,25	75	3720160220	2A KBLO KSC 200	804,25	146
0130012528	2A ANH UB 2528	212,00	74	1800070607	2A KVN ANH 0607	124,25	117
0130012729	2A ANH UB 2729	264,50	74	1800070809	2A KVN ANH 0809	136,00	117
0130012730	2A ANH UB 2730	264,50	74	1800071011	2A KVN ANH 1011	186,00	117
0130012732	2A ANH UB 2732	264,50	74	1800071213	2A KVN ANH 1213	197,50	117
0161011920	2A ANH UB 3/4X25/32 SAE	158,00	75	1800071415	2A KVN ANH 1415	216,50	117
0161011922	2A ANH UB 3/4X7/8 SAE	183,25	75	1800071617	2A KVN ANH 1617	232,25	117



KOD	ÜRÜN	FIYAT	SAYFA	KOD	ÜRÜN	FIYAT	SAYFA
1800071819	2A KVN ANH 1819	241,00	117	0430031819	2A YLD ANH SB 1819	257,25	84
1800072022	2A KVN ANH 2022	265,25	117	0450031819	2A YLD ANH SB 1819 ELTA	213,50	230
1800072224	2A KVN ANH 2224	298,00	117	0431031517	2A YLD ANH SB 19/32X11/16 SAE	259,75	85
1800072427	2A KVN ANH 2427	384,75	117	0430031922	2A YLD ANH SB 1922	282,00	84
1800002108	2A KVN ANH SET10	1.722,50	117	0430031924	2A YLD ANH SB 1924	282,00	84
0540010810	2A RKR ANH 0810	262,25	87	0431032528	2A YLD ANH SB 1X1-1/8 SAE		85
0540011011	2A RKR ANH 1011	272,25	87	0430032022	2A YLD ANH SB 2022	282,00	84
0540011012	2A RKR ANH 1012	272,25	87	0450032022	2A YLD ANH SB 2022 ELTA	233,25	230
0540011113	2A RKR ANH 1113	291,25	87	0430032123	2A YLD ANH SB 2123	323,25	84
0540011214	2A RKR ANH 1214	291,25	87	0450032123	2A YLD ANH SB 2123 ELTA	267,75	230
0540011719	2A RKR ANH 1719	520,00	87	0430032224	2A YLD ANH SB 2224	323,25	84
0540011922	2A RKR ANH 1922	622,50	87	0430032227	2A YLD ANH SB 2227		84
6240260810	2A TAPA ANH 08X10	281,50	199	0430032426	2A YLD ANH SB 2426	376,75	84
0430030607	2A YLD ANH SB 0607	143,00	84	0450032426	2A YLD ANH SB 2426 ELTA	311,50	230
0450030607	2A YLD ANH SB 0607 ELTA	118,50	230	0430032427	2A YLD ANH SB 2427	376,75	84
0430030809	2A YLD ANH SB 0809	145,00	84	0430032430	2A YLD ANH SB 2430	412,25	84
0450030809	2A YLD ANH SB 0809 ELTA	120,00	230	0431032021	2A YLD ANH SB 25/32X13/16 SAE		85
0430030810	2A YLD ANH SB 0810	145,00	84	0430032528	2A YLD ANH SB 2528	412,25	84
0431031217	2A YLD ANH SB 1/2X11/16 SAE		85	0450032528	2A YLD ANH SB 2528 ELTA	341,00	230
0431031214	2A YLD ANH SB 1/2X9/16 SAE	229,75	85	0430032729	2A YLD ANH SB 2729	453,50	84
0431030608	2A YLD ANH SB 1/4X5/16 SAE	176,25	85	0430032730	2A YLD ANH SB 2730	453,50	84
0430031011	2A YLD ANH SB 1011	160,25	84	0430032732	2A YLD ANH SB 2732	453,50	84
0450031011	2A YLD ANH SB 1011 ELTA	133,50	230	0450032732	2A YLD ANH SB 2732 ELTA	376,00	230
0430031012	2A YLD ANH SB 1012	160,25	84	0431031920	2A YLD ANH SB 3/4X25/32 SAE	322,25	85
0430031013	2A YLD ANH SB 1013	181,50	84	0431031922	2A YLD ANH SB 3/4X7/8 SAE		85
0430031014	2A YLD ANH SB 1014		84	0431030911	2A YLD ANH SB 3/8X7/16 SAE	202,00	85
0431032631	2A YLD ANH SB 1-1/16X1-1/4 SAE	544,00	85	0430033032	2A YLD ANH SB 3032	453,50	84
0431033236	2A YLD ANH SB 1-1/4X1-7/16 SAE		85	0430033034	2A YLD ANH SB 3034		84
0431032833	2A YLD ANH SB 1-1/8X1-5/16 SAE	544,00	85	0430033036	2A YLD ANH SB 3036	699,00	84
0431034146	2A YLD ANH SB 1-11/16X1-7/8 SAE		85	0430033236	2A YLD ANH SB 3236	699,00	84
0430031113	2A YLD ANH SB 1113	181,50	84	0430033436	2A YLD ANH SB 3436	854,75	84
0431034650	2A YLD ANH SB 1-13/16X2 SAE		85	0430033641	2A YLD ANH SB 3641	949,50	84
0430031213	2A YLD ANH SB 1213	181,50	84	0430034146	2A YLD ANH SB 4146	1.300,75	84
0450031213	2A YLD ANH SB 1213 ELTA	150,25	230	0430034650	2A YLD ANH SB 4650	2.069,50	84
0430031214	2A YLD ANH SB 1214	181,50	84	0431030809	2A YLD ANH SB 5/16X3/8 SAE	183,25	85
0431033036	2A YLD ANH SB 1-3/16 X1-3/8 SAE		85	0431030811	2A YLD ANH SB 5/16X7/16 SAE	191,50	85
0431033033	2A YLD ANH SB 1-3/16X1-5/16 SAE	580,00	85	0431031617	2A YLD ANH SB 5/8X11/16 SAE		85
0431032122	2A YLD ANH SB 13/16X7/8 SAE	387,25	85	0431031619	2A YLD ANH SB 5/8X3/4 SAE		85
0430031315	2A YLD ANH SB 1315		84	0431031112	2A YLD ANH SB 7/16X1/2 SAE	218,00	85
0430031317	2A YLD ANH SB 1317	216,50	84	0431032223	2A YLD ANH SB 7/8X15/16 SAE		85
0430031415	2A YLD ANH SB 1415	191,25	84	0431031417	2A YLD ANH SB 9/16x11/16 SAE		85
0450031415	2A YLD ANH SB 1415 ELTA	158,00	230	0431031415	2A YLD ANH SB 9/16X19/32 SAE	229,75	85
0430031417	2A YLD ANH SB 1417	216,50	84	0431031416	2A YLD ANH SB 9/16X5/8 SAE	232,00	85
0431032325	2A YLD ANH SB 15/16X1 SAE	452,00	85	8002316012	2A YLD ANH SB SHP	428,25	249
0431032328	2A YLD ANH SB 15/16x1-1/8 SAE		85	0430002112	2A YLD ANH SB TK12	3.142,50	84
0430031617	2A YLD ANH SB 1617	216,50	84	0450002112	2A YLD ANH SB TK12 ELTA	2.602,00	230
0450031617	2A YLD ANH SB 1617 ELTA	178,75	230	0431002112	2A YLD ANH SB TK12 SAE	4.100,75	85
0430031618	2A YLD ANH SB 1618	257,25	84	0430002108	2A YLD ANH SB TK8	1.576,75	84
0431033641	2A YLD ANH SB 1-7/16X1-5/8 SAE		85	0450002108	2A YLD ANH SB TK8 ELTA	1.305,75	230
0430031719	2A YLD ANH SB 1719	257,25	84	0431002108	2A YLD ANH SB TK8 SAE	2.230,75	85

KOD	ÜRÜN	FİYAT	SAYFA	KOD	ÜRÜN	FİYAT	SAYFA
6375266512	2YÖN 3AYK YAĞ FLT SÖKM 65-120	1.458,25	200	14000004522	3/4" 6KŞ HVL DRN LKM ANH 36	884,50	126
6380266016	2ZNCR YAĞ FLT SÖKM 60-16	3.948,50	200	14000004523	3/4" 6KŞ HVL DRN LKM ANH 38	980,75	126
0741550003	3 SRL TEL FRÇ	64,75	201	14000004524	3/4" 6KŞ HVL DRN LKM ANH 41	1.173,00	126
2201100030	3" MŞL BORU ANH 85	2.949,00	133	14000004525	3/4" 6KŞ HVL DRN LKM ANH 46	1.288,50	126
2201100130	3" MŞL BORU ANH YP SMN 85	96,00	242	14000004526	3/4" 6KŞ HVL DRN LKM ANH 50	1.605,75	126
1419061025	3/4" 12KŞ LKM ANH 1 SAE	296,50	115	14000004527	3/4" 6KŞ HVL DRN LKM ANH 55	1.921,25	126
1419061027	3/4" 12KŞ LKM ANH 1-1/16 SAE	304,50	115	1119067017	3/4" 6KŞ HVL LKM ANH 17	461,50	126
1419061038	3/4" 12KŞ LKM ANH 1-1/2 SAE	445,00	115	1119067018	3/4" 6KŞ HVL LKM ANH 18	461,50	126
1419061032	3/4" 12KŞ LKM ANH 1-1/4 SAE	341,00	115	1119067019	3/4" 6KŞ HVL LKM ANH 19	461,50	126
1419061028	3/4" 12KŞ LKM ANH 1-1/8 SAE	304,50	115	1119067020	3/4" 6KŞ HVL LKM ANH 20	461,50	126
1419061046	3/4" 12KŞ LKM ANH 1-13/16 SAE	700,00	115	1119067021	3/4" 6KŞ HVL LKM ANH 21	461,50	126
1419061044	3/4" 12KŞ LKM ANH 1-3/4 SAE	695,50	115	1119067022	3/4" 6KŞ HVL LKM ANH 22	461,50	126
1419061035	3/4" 12KŞ LKM ANH 1-3/8 SAE	424,75	115	1119067023	3/4" 6KŞ HVL LKM ANH 23	461,50	126
1419061024	3/4" 12KŞ LKM ANH 15/16 SAE	295,50	115	1119067024	3/4" 6KŞ HVL LKM ANH 24	461,50	126
1419061033	3/4" 12KŞ LKM ANH 1-5/16 SAE	424,75	115	1119067025	3/4" 6KŞ HVL LKM ANH 25	461,50	126
1419061041	3/4" 12KŞ LKM ANH 1-5/8 SAE	659,25	115	1119067026	3/4" 6KŞ HVL LKM ANH 26	461,50	126
1419061036	3/4" 12KŞ LKM ANH 1-7/16 SAE	445,00	115	1119067027	3/4" 6KŞ HVL LKM ANH 27	461,50	126
1419061047	3/4" 12KŞ LKM ANH 1-7/8 SAE	839,75	115	1119067028	3/4" 6KŞ HVL LKM ANH 28	461,50	126
1419061050	3/4" 12KŞ LKM ANH 2 SAE	845,50	115	1119067029	3/4" 6KŞ HVL LKM ANH 29	461,50	126
1120061022	3/4" 12KŞ LKM ANH 22	281,50	115	1119067030	3/4" 6KŞ HVL LKM ANH 30	461,50	126
1120061024	3/4" 12KŞ LKM ANH 24	281,50	115	1119067032	3/4" 6KŞ HVL LKM ANH 32	461,50	126
1120061027	3/4" 12KŞ LKM ANH 27	290,75	115	1119067033	3/4" 6KŞ HVL LKM ANH 33	519,25	126
1120061030	3/4" 12KŞ LKM ANH 30	312,75	115	1119067034	3/4" 6KŞ HVL LKM ANH 34	594,00	126
1120061032	3/4" 12KŞ LKM ANH 32	327,00	115	1119067035	3/4" 6KŞ HVL LKM ANH 35	528,75	126
1120061034	3/4" 12KŞ LKM ANH 34	430,00	115	1119067036	3/4" 6KŞ HVL LKM ANH 36	594,00	126
1120061036	3/4" 12KŞ LKM ANH 36	430,00	115	1119067038	3/4" 6KŞ HVL LKM ANH 38	577,00	126
1120061041	3/4" 12KŞ LKM ANH 41	635,00	115	1119067041	3/4" 6KŞ HVL LKM ANH 41	916,50	126
1120061046	3/4" 12KŞ LKM ANH 46	675,00	115	1119067044	3/4" 6KŞ HVL LKM ANH 44	970,00	126
1120061050	3/4" 12KŞ LKM ANH 50	807,75	115	1119067046	3/4" 6KŞ HVL LKM ANH 46	974,25	126
1419061022	3/4" 12KŞ LKM ANH 7/8 SAE	295,50	115	1119067050	3/4" 6KŞ HVL LKM ANH 50	1.115,50	126
1120006014	3/4" 12KŞ LKM ANH SET14	10.475,75	116	1119067055	3/4" 6KŞ HVL LKM ANH 55	1.269,25	126
1419006114	3/4" 12KŞ LKM ANH SET14 SAE	10.889,00	116	1119067060	3/4" 6KŞ HVL LKM ANH 60	1.557,75	126
14000004504	3/4" 6KŞ HVL DRN LKM ANH 17	702,00	126	1119061022	3/4" 6KŞ LKM ANH 22	266,75	115
14000004505	3/4" 6KŞ HVL DRN LKM ANH 18	702,00	126	1119061024	3/4" 6KŞ LKM ANH 24	266,75	115
14000004506	3/4" 6KŞ HVL DRN LKM ANH 19	702,00	126	1119061027	3/4" 6KŞ LKM ANH 27	275,00	115
14000004507	3/4" 6KŞ HVL DRN LKM ANH 20	702,00	126	1119061030	3/4" 6KŞ LKM ANH 30	296,50	115
14000004508	3/4" 6KŞ HVL DRN LKM ANH 21	702,00	126	1119061032	3/4" 6KŞ LKM ANH 32	308,25	115
14000004509	3/4" 6KŞ HVL DRN LKM ANH 22	702,00	126	1119061034	3/4" 6KŞ LKM ANH 34	406,75	115
14000004510	3/4" 6KŞ HVL DRN LKM ANH 23	702,00	126	1119061036	3/4" 6KŞ LKM ANH 36	406,75	115
14000004511	3/4" 6KŞ HVL DRN LKM ANH 24	702,00	126	1119061038	3/4" 6KŞ LKM ANH 38	406,75	115
14000004512	3/4" 6KŞ HVL DRN LKM ANH 25	702,00	126	1119061041	3/4" 6KŞ LKM ANH 41	597,50	115
14000004513	3/4" 6KŞ HVL DRN LKM ANH 26	702,00	126	1119061046	3/4" 6KŞ LKM ANH 46	636,50	115
14000004514	3/4" 6KŞ HVL DRN LKM ANH 27	702,00	126	1119061050	3/4" 6KŞ LKM ANH 50	764,00	115
14000004515	3/4" 6KŞ HVL DRN LKM ANH 28	721,25	126	1119061055	3/4" 6KŞ LKM ANH 55	972,75	115
14000004516	3/4" 6KŞ HVL DRN LKM ANH 29	730,75	126	1119061060	3/4" 6KŞ LKM ANH 60	1.161,50	115
14000004517	3/4" 6KŞ HVL DRN LKM ANH 30	730,75	126	1119006114	3/4" 6KŞ LKM ANH SET 14	10.229,25	116
14000004518	3/4" 6KŞ HVL DRN LKM ANH 32	730,75	126	1519064200	3/4" ARA KOL 200	696,75	115
14000004519	3/4" 6KŞ HVL DRN LKM ANH 33	788,50	126	1519064400	3/4" ARA KOL 400	1.262,00	115
14000004520	3/4" 6KŞ HVL DRN LKM ANH 34	817,25	126	1519064510	3/4" CRC KOL 510	2.641,75	115
14000004521	3/4" 6KŞ HVL DRN LKM ANH 35	884,50	126	1619061060	3/4" CRC TORK ANH 100-600NM	21.431,75	119



KOD	ÜRÜN	FİYAT	SAYFA	KOD	ÜRÜN	FİYAT	SAYFA
14000004528	3/4" HVL ALLEN UÇ LKM ANH 14	1.125,00	126	14000004601	3/8" 6KŞ HVL DRN LKM ANH 6	231,00	122
14000004529	3/4" HVL ALLEN UÇ LKM ANH 17	1.125,00	126	14000004602	3/8" 6KŞ HVL DRN LKM ANH 7	231,00	122
14000004530	3/4" HVL ALLEN UÇ LKM ANH 19	1.125,00	126	14000004603	3/8" 6KŞ HVL DRN LKM ANH 8	231,00	122
14000004531	3/4" HVL ALLEN UÇ LKM ANH 21	1.125,00	126	14000004604	3/8" 6KŞ HVL DRN LKM ANH 9	231,00	122
14000004532	3/4" HVL ALLEN UÇ LKM ANH 22	1.125,00	126	14000004583	3/8" 6KŞ HVL LKM ANH 06	120,00	122
14000004533	3/4" HVL ALLEN UÇ LKM ANH 24	1.211,50	126	14000004584	3/8" 6KŞ HVL LKM ANH 07	120,00	122
14000004534	3/4" HVL ALLEN UÇ LKM ANH 27	1.211,50	126	14000004585	3/8" 6KŞ HVL LKM ANH 08	120,00	122
14000004535	3/4" HVL ALLEN UÇ LKM ANH 30	1.211,50	126	14000004586	3/8" 6KŞ HVL LKM ANH 09	120,00	122
14000004536	3/4" HVL ALLEN UÇ LKM ANH 32	1.336,50	126	14000004587	3/8" 6KŞ HVL LKM ANH 10	120,00	122
14000004537	3/4" HVL ALLEN UÇ LKM ANH 36	1.384,50	126	14000004588	3/8" 6KŞ HVL LKM ANH 11	120,00	122
1519067175	3/4" HVL LKM ARA KOL 175	1.012,50	127	14000004589	3/8" 6KŞ HVL LKM ANH 12	120,00	122
1519067250	3/4" HVL LKM ARA KOL 250	1.447,75	127	14000004590	3/8" 6KŞ HVL LKM ANH 13	125,00	122
1519067330	3/4" HVL LKM ARA KOL 330	2.197,25	127	14000004591	3/8" 6KŞ HVL LKM ANH 14	125,00	122
1519067108	3/4" HVL LKM MFSL 108	1.686,25	127	14000004592	3/8" 6KŞ HVL LKM ANH 15	142,25	122
1519064500	3/4" T KOL 500	1.404,00	116	14000004593	3/8" 6KŞ HVL LKM ANH 16	142,25	122
1619062080	3/4" TORK ANH 200-800NM	30.510,00	119	14000004594	3/8" 6KŞ HVL LKM ANH 17	142,25	122
14000004538	3/4"FX1" M HVL LKM ADP	759,50	127	14000004595	3/8" 6KŞ HVL LKM ANH 18	142,25	122
1519060001	3/4"FX1" M LKM ADP	376,00	116	14000004596	3/8" 6KŞ HVL LKM ANH 19	160,00	122
1519067011	3/4"FX1/2" M HVL LKM ADP	584,50	127	14000004597	3/8" 6KŞ HVL LKM ANH 20	165,00	122
1519060008	3/4"FX1/2" M LKM ADP	278,00	116	14000004598	3/8" 6KŞ HVL LKM ANH 21	169,00	122
14000004965	3/8" 6KŞ DRN LKM ANH 06	126,00	103	14000004599	3/8" 6KŞ HVL LKM ANH 22	191,25	122
14000004966	3/8" 6KŞ DRN LKM ANH 07	126,00	103	14000004600	3/8" 6KŞ HVL LKM ANH 23	191,25	122
14000004967	3/8" 6KŞ DRN LKM ANH 08	126,00	103	1110060006	3/8" 6KŞ LKM ANH 06	67,50	103
14000004968	3/8" 6KŞ DRN LKM ANH 09	126,00	103	1110060007	3/8" 6KŞ LKM ANH 07	67,50	103
14000004969	3/8" 6KŞ DRN LKM ANH 10	126,00	103	1110060008	3/8" 6KŞ LKM ANH 08	67,50	103
14000004970	3/8" 6KŞ DRN LKM ANH 11	126,00	103	1110060009	3/8" 6KŞ LKM ANH 09	67,50	103
14000004971	3/8" 6KŞ DRN LKM ANH 12	126,00	103	1110060010	3/8" 6KŞ LKM ANH 10	67,50	103
14000004972	3/8" 6KŞ DRN LKM ANH 13	129,75	103	1110060011	3/8" 6KŞ LKM ANH 11	67,50	103
14000004973	3/8" 6KŞ DRN LKM ANH 14	129,75	103	1110060012	3/8" 6KŞ LKM ANH 12	67,50	103
14000004974	3/8" 6KŞ DRN LKM ANH 15	129,75	103	1110060013	3/8" 6KŞ LKM ANH 13	71,75	103
14000004975	3/8" 6KŞ DRN LKM ANH 16	129,75	103	1110060014	3/8" 6KŞ LKM ANH 14	71,75	103
14000004976	3/8" 6KŞ DRN LKM ANH 17	174,00	103	1110060015	3/8" 6KŞ LKM ANH 15	71,75	103
14000004977	3/8" 6KŞ DRN LKM ANH 18	174,00	103	1110060016	3/8" 6KŞ LKM ANH 16	74,75	103
14000004978	3/8" 6KŞ DRN LKM ANH 19	178,00	103	1110060017	3/8" 6KŞ LKM ANH 17	74,75	103
14000004980	3/8" 6KŞ DRN LKM ANH 21	203,75	103	1110060018	3/8" 6KŞ LKM ANH 18	78,00	103
14000004981	3/8" 6KŞ DRN LKM ANH 22	240,50	103	1110060019	3/8" 6KŞ LKM ANH 19	89,75	103
14000004605	3/8" 6KŞ HVL DRN LKM ANH 10	231,00	122	1110060021	3/8" 6KŞ LKM ANH 21	101,25	103
14000004606	3/8" 6KŞ HVL DRN LKM ANH 11	231,00	122	1110060022	3/8" 6KŞ LKM ANH 22	108,25	103
14000004607	3/8" 6KŞ HVL DRN LKM ANH 12	231,00	122	1110060023	3/8" 6KŞ LKM ANH 23	108,25	103
14000004608	3/8" 6KŞ HVL DRN LKM ANH 13	240,50	122	1110060019	3/8" 6KŞ LKM SET 19	2.722,50	105
14000004609	3/8" 6KŞ HVL DRN LKM ANH 14	240,50	122	1510060150	3/8" ARA KOL 150	184,25	104
14000004610	3/8" 6KŞ HVL DRN LKM ANH 15	246,25	122	1510060075	3/8" ARA KOL 75	122,00	104
14000004611	3/8" 6KŞ HVL DRN LKM ANH 16	246,25	122	1110069208	3/8" BUJİ LKM LSTK 20,8	144,00	103
14000004612	3/8" 6KŞ HVL DRN LKM ANH 17	276,00	122	1510060200	3/8" CRC KOL 200	800,75	104
14000004613	3/8" 6KŞ HVL DRN LKM ANH 18	281,00	122	1610062010	3/8" CRC TORK ANH 20-100NM	6.598,75	119
14000004614	3/8" 6KŞ HVL DRN LKM ANH 19	281,00	122	14000004620	3/8" HVL LKM ARA KOL 125	344,25	123
14000004615	3/8" 6KŞ HVL DRN LKM ANH 20	292,00	122	14000004619	3/8" HVL LKM ARA KOL 75	259,50	123
14000004616	3/8" 6KŞ HVL DRN LKM ANH 21	293,00	122	14000004622	3/8" HVL LKM MFSL 50	561,50	123
14000004617	3/8" 6KŞ HVL DRN LKM ANH 22	293,00	122	14000004985	3/8" LKM TORX UÇ T10	120,25	104
14000004618	3/8" 6KŞ HVL DRN LKM ANH 23	308,00	122	14000004986	3/8" LKM TORX UÇ T15	120,25	104

KOD	ÜRÜN	FİYAT	SAYFA	KOD	ÜRÜN	FİYAT	SAYFA
14000004987	3/8" LKM TORX UÇ T20	120,25	104	4901221270	6KŞ ALLEN ANH 1/2 SAE	150,00	179
14000004988	3/8" LKM TORX UÇ T25	120,25	104	4901226350	6KŞ ALLEN ANH 1/4 SAE	52,00	179
14000004989	3/8" LKM TORX UÇ T27	120,25	104	4901223125	6KŞ ALLEN ANH 1/8 SAE	25,50	179
14000004990	3/8" LKM TORX UÇ T30	120,25	104	4908220100	6KŞ ALLEN ANH 10 ELTA	68,25	237
14000004991	3/8" LKM TORX UÇ T40	120,25	104	4908220120	6KŞ ALLEN ANH 12 ELTA	99,50	237
14000004992	3/8" LKM TORX UÇ T45	137,50	104	4908220025	6KŞ ALLEN ANH 2,5 ELTA	12,75	237
14000004983	3/8" LKM TORX UÇ T8	105,75	104	4908220035	6KŞ ALLEN ANH 3,5 ELTA	16,75	237
14000004984	3/8" LKM TORX UÇ T9	105,75	104	4901224762	6KŞ ALLEN ANH 3/16 SAE	32,00	179
1510060056	3/8" MFSL 56,5	197,50	104	4901222381	6KŞ ALLEN ANH 3/32 SAE	21,25	179
1510061200	3/8" T KOL	284,00	105	4901221905	6KŞ ALLEN ANH 3/4 SAE	474,50	179
1610060100	3/8" TORX ANH 2,5-11NM	7.383,50	119	4901229825	6KŞ ALLEN ANH 3/8 SAE	88,75	179
1610060300	3/8" TORX ANH 7-33NM	7.633,75	119	4901227937	6KŞ ALLEN ANH 5/16 SAE	64,50	179
14000005006	3/8" TORX LKM ANH E10	95,75	103	4901223968	6KŞ ALLEN ANH 5/32 SAE	31,00	179
14000005007	3/8" TORX LKM ANH E11	95,75	103	4901221984	6KŞ ALLEN ANH 5/64 SAE	19,50	179
14000005008	3/8" TORX LKM ANH E12	95,75	103	4901221587	6KŞ ALLEN ANH 5/8 SAE	339,25	179
14000005009	3/8" TORX LKM ANH E14	95,75	103	4901221111	6KŞ ALLEN ANH 7/16 SAE	119,00	179
14000005010	3/8" TORX LKM ANH E16	99,00	103	4901225556	6KŞ ALLEN ANH 7/32 SAE	42,50	179
14000005011	3/8" TORX LKM ANH E18	102,00	103	4901221428	6KŞ ALLEN ANH 9/16 SAE	218,25	179
14000005001	3/8" TORX LKM ANH E4	95,75	103	4900220020	6KŞ ALLEN ANH KB 02	14,75	179
14000005002	3/8" TORX LKM ANH E5	95,75	103	4900220030	6KŞ ALLEN ANH KB 03	19,50	179
14000005003	3/8" TORX LKM ANH E6	95,75	103	4900220040	6KŞ ALLEN ANH KB 04	25,25	179
14000005004	3/8" TORX LKM ANH E7	95,75	103	4900220050	6KŞ ALLEN ANH KB 05	29,00	179
14000005005	3/8" TORX LKM ANH E8	95,75	103	4900220060	6KŞ ALLEN ANH KB 06	38,00	179
14000005000	3/8" LOKMALI ALLEN UÇ 10	152,00	104	4900220070	6KŞ ALLEN ANH KB 07	56,00	179
14000004993	3/8" LOKMALI ALLEN UÇ 3	120,25	104	4900220080	6KŞ ALLEN ANH KB 08	64,50	179
14000004994	3/8" LOKMALI ALLEN UÇ 4	120,25	104	4900220090	6KŞ ALLEN ANH KB 09	79,25	179
14000004995	3/8" LOKMALI ALLEN UÇ 5	120,25	104	4900220100	6KŞ ALLEN ANH KB 10	97,75	179
14000004996	3/8" LOKMALI ALLEN UÇ 6	120,25	104	4900220120	6KŞ ALLEN ANH KB 12	141,50	179
14000004997	3/8" LOKMALI ALLEN UÇ 7	130,00	104	4900220140	6KŞ ALLEN ANH KB 14	226,00	179
14000004998	3/8" LOKMALI ALLEN UÇ 8	130,00	104	4900220160	6KŞ ALLEN ANH KB 16	416,00	179
14000004999	3/8" LOKMALI ALLEN UÇ 9	152,00	104	4900220170	6KŞ ALLEN ANH KB 17	449,00	179
14000004621	3/8" FX1/2" M HVL LKM ADP	186,50	123	4900220190	6KŞ ALLEN ANH KB 19	554,75	179
1510060007	3/8" FX1/2" M LKM ADP	136,00	105	4900220025	6KŞ ALLEN ANH KB 2,5	18,25	179
14000005134	3/8" 6KŞ LKM ANH SET24	3.548,00	105	4900220220	6KŞ ALLEN ANH KB 22	926,25	179
14000005135	3/8" 6KŞ LKM ANH & LKM ALLEN SET35	3.202,00	105	4900220240	6KŞ ALLEN ANH KB 24	1.250,00	179
0741550004	4 SRL TEL FRÇ	68,25	201	4900220035	6KŞ ALLEN ANH KB 3,5	24,75	179
2201100040	4" MŞL BORU ANH 85	4.422,50	133	4900003110	6KŞ ALLEN ANH KB TK10	442,25	179
2201100140	4" MŞL BORU ANH YP SMN 85	113,00	242	4900003112	6KŞ ALLEN ANH KB TK12	608,50	179
0741550005	5 SRL TEL FRÇ	76,25	201	4908003110	6KŞ ALLEN ANH TK10 ELTA	327,00	237
0741550006	6 SRL TEL FRÇ	81,75	201	4901003110	6KŞ ALLEN ANH TK10 SAE	496,00	179
4908220020	6KŞ ALLEN ANH 02 ELTA	11,00	237	4901003112	6KŞ ALLEN ANH TK12 SAE	864,25	179
4908220030	6KŞ ALLEN ANH 03 ELTA	14,75	237	4908003107	6KŞ ALLEN ANH TK7 ELTA	114,25	237
4908220040	6KŞ ALLEN ANH 04 ELTA	19,25	237	4908003109	6KŞ ALLEN ANH TK9 ELTA	227,50	237
4908220050	6KŞ ALLEN ANH 05 ELTA	20,25	237	4903220020	6KŞ ALLEN ANH UB 02	21,25	180
4908220060	6KŞ ALLEN ANH 06 ELTA	27,50	237	4903220030	6KŞ ALLEN ANH UB 03	28,25	180
4908220070	6KŞ ALLEN ANH 07 ELTA	39,00	237	4903220040	6KŞ ALLEN ANH UB 04	35,50	180
4908220080	6KŞ ALLEN ANH 08 ELTA	45,00	237	4903220050	6KŞ ALLEN ANH UB 05	39,50	180
4908220090	6KŞ ALLEN ANH 09 ELTA	63,25	237	4903220060	6KŞ ALLEN ANH UB 06	64,50	180
4900220015	6KŞ ALLEN ANH 1,5	10,25	179	4903220070	6KŞ ALLEN ANH UB 07	95,25	180
4908220015	6KŞ ALLEN ANH 1,5 ELTA	8,75	237	4903220080	6KŞ ALLEN ANH UB 08	103,75	180



KOD	ÜRÜN	FİYAT	SAYFA	KOD	ÜRÜN	FİYAT	SAYFA
4903220090	6KŞ ALLEN ANH UB 09	140,50	180	2110100424	AGR BORU ANH YP AÇENE&PİM 24"	855,00	242
4903220100	6KŞ ALLEN ANH UB 10	174,00	180	2110100436	AGR BORU ANH YP AÇENE&PİM 36"	1.363,75	242
4903220120	6KŞ ALLEN ANH UB 12	249,75	180	2110100448	AGR BORU ANH YP AÇENE&PİM 48"	1.840,75	242
4903220140	6KŞ ALLEN ANH UB 14	402,25	180	2110100408	AGR BORU ANH YP AÇENE&PİM 8"	582,50	242
4903220160	6KŞ ALLEN ANH UB 16	650,25	180	2110100110	AGR BORU ANH YP ÇENE 10"	672,25	242
4903220170	6KŞ ALLEN ANH UB 17	708,25	180	2110100112	AGR BORU ANH YP ÇENE 12"	1.326,25	242
4903220190	6KŞ ALLEN ANH UB 19	1.049,25	180	2110100114	AGR BORU ANH YP ÇENE 14"	1.414,50	242
4903220025	6KŞ ALLEN ANH UB 2,5	24,75	180	2110100118	AGR BORU ANH YP ÇENE 18"	1.503,00	242
4903220035	6KŞ ALLEN ANH UB 3,5	34,50	180	2110100124	AGR BORU ANH YP ÇENE 24"	2.254,00	242
4903003110	6KŞ ALLEN ANH UB TK10	727,25	180	2110100136	AGR BORU ANH YP ÇENE 36"	4.506,50	242
4903003112	6KŞ ALLEN ANH UB TK12	1.011,50	180	2110100148	AGR BORU ANH YP ÇENE 48"	7.422,00	242
4905220020	6KŞ YVRL BAŞL ALLEN ANH KB 02	23,75	180	2110100108	AGR BORU ANH YP ÇENE 8"	553,25	242
4905220030	6KŞ YVRL BAŞL ALLEN ANH KB 03	32,50	180	2110100310	AGR BORU ANH YP SMN 10"	191,25	242
4905220040	6KŞ YVRL BAŞL ALLEN ANH KB 04	40,00	180	2110100312	AGR BORU ANH YP SMN 12"	208,75	242
4905220050	6KŞ YVRL BAŞL ALLEN ANH KB 05	42,25	180	2110100314	AGR BORU ANH YP SMN 14"	252,75	242
4905220060	6KŞ YVRL BAŞL ALLEN ANH KB 06	68,00	180	2110100318	AGR BORU ANH YP SMN 18"	336,75	242
4905220080	6KŞ YVRL BAŞL ALLEN ANH KB 08	104,00	180	2110100324	AGR BORU ANH YP SMN 24"	513,00	242
4905220100	6KŞ YVRL BAŞL ALLEN ANH KB 10	165,25	180	2110100336	AGR BORU ANH YP SMN 36"	951,00	242
4905220025	6KŞ YVRL BAŞL ALLEN ANH KB 2,5	28,50	180	2110100348	AGR BORU ANH YP SMN 48"	1.525,00	242
4905007108	6KŞ YVRL BAŞL ALLEN ANH KB TK8	504,25	180	2110100308	AGR BORU ANH YP SMN 8"	182,25	242
4906220020	6KŞ YVRL BAŞL ALLEN ANH UB 02	42,25	181	3835150280	AGR BTN KRPTN 280	748,75	149
4906220030	6KŞ YVRL BAŞL ALLEN ANH UB 03	49,00	181	3030122180	AGR KMB PNS 180	763,50	137
4906220040	6KŞ YVRL BAŞL ALLEN ANH UB 04	56,00	181	3030122200	AGR KMB PNS 200	873,50	137
4906220050	6KŞ YVRL BAŞL ALLEN ANH UB 05	70,25	181	3730162160	AGR YNKS 160	793,75	142
4906220060	6KŞ YVRL BAŞL ALLEN ANH UB 06	80,75	181	3730162200	AGR YNKS 200	1.031,50	142
4906220080	6KŞ YVRL BAŞL ALLEN ANH UB 08	128,00	181	6207270240	AL&SAC KSM MKS 240 DÜZ	686,50	213
4906220015	6KŞ YVRL BAŞL ALLEN ANH UB 1,5	31,75	181	6205270240	AL&SAC KSM MKS 240 SAĞ	686,50	213
4906220100	6KŞ YVRL BAŞL ALLEN ANH UB 10	190,25	181	6206270240	AL&SAC KSM MKS 240 SOL	686,50	213
4906220025	6KŞ YVRL BAŞL ALLEN ANH UB 2,5	45,75	181	6208000240	AL&SAC KSM MKS TK3	2.059,50	213
4906003109	6KŞ YVRL BAŞL ALLEN ANH UB TK9	694,00	181	0588650020	ARZTİP FİB ŞRT SAPLI MT20	539,75	196
14000005080	ADP BİTS UÇ SET 71 ELTA	2.115,50	231	0588650030	ARZTİP FİB ŞRT SAPLI MT30	576,75	196
1874092224	AGR 2A BUN ANH KB 2224	333,50	118	0588650050	ARZTİP FİB ŞRT SAPLI MT50	926,25	196
1874092427	AGR 2A BUN ANH KB 2427	425,75	118	0615010200	AYR MNT ANH 200	753,25	90
1870092427	AGR 2A BUN ANH UB 2427	526,00	118	2509110225	AYR PNS 225 ELTA	637,50	234
1870092730	AGR 2A BUN ANH UB 2730	604,00	118	0637550100	AYR YAĞ FLT SÖKM 100	488,25	200
1870092732	AGR 2A BUN ANH UB 2732	604,00	118	6721270205	BAĞ MKS 205 ELTA	441,50	239
1870093032	AGR 2A BUN ANH UB 3032	625,00	118	14000005136	BAĞ MKS AL GVD	865,50	217
1870093233	AGR 2A BUN ANH UB 3233	693,50	118	6715270225	BAĞ MKS COMF 225	941,75	216
2110100010	AGR BORU ANH 10"	1.358,50	133	6720270220	BAĞ MKS HAF 220	1.092,75	216
2110100012	AGR BORU ANH 12"	1.555,50	133	6722270220	BAĞ MKS HAF 220 ELTA	636,75	239
2110100014	AGR BORU ANH 14"	1.811,00	133	6710270230	BAĞ MKS LUX 230	619,00	216
2110100018	AGR BORU ANH 18"	2.526,75	133	14000005137	BDM MAKASI DVM ÖRS ÇENE	750,00	217
2110100024	AGR BORU ANH 24"	4.074,25	133	6735270300	BDM TSTR 300	844,25	196
2110100036	AGR BORU ANH 36"	9.023,00	133	6735271300	BDM TSTR YP BÇK 300	771,00	244
2110100048	AGR BORU ANH 48"	18.479,75	133	14000004137	BEL BTKÇ	635,00	68
2110100008	AGR BORU ANH 8"	1.094,50	133	0589950283	BİMETAL TSTR YP LAMA 13X0,65X24	102,75	244
2110100410	AGR BORU ANH YP AÇENE&PİM 10"	645,75	242	4800008131	BİTS UÇ PLS KUTU SET31	729,75	174
2110100412	AGR BORU ANH YP AÇENE&PİM 12"	727,75	242	4800008110	BİTS UÇ SET10(25)	217,25	174
2110100414	AGR BORU ANH YP AÇENE&PİM 14"	750,75	242	4850001013	BİTS UÇ SET13(100)	885,25	178
2110100418	AGR BORU ANH YP AÇENE&PİM 18"	777,25	242	4850001513	BİTS UÇ SET13(150)	1.260,50	178

KOD	ÜRÜN	FİYAT	SAYFA	KOD	ÜRÜN	FİYAT	SAYFA
4850000713	BİTS UÇ SET13(75)	593,00	178	7060290604	BTR ÇEK 3KOL 6X4	1.010,75	222
4800008106	BİTS UÇ SET6(25)	117,50	174	7060290606	BTR ÇEK 3KOL 6X6	1.274,00	222
1975091719	BJN ANH İSTV	650,25	118	7060290808	BTR ÇEK 3KOL 8X8	1.477,75	222
1850091630	BJN ANH MİL 18X630	306,25	118	7050290422	BTR ÇEK YP KOL 6X4	134,00	245
1940090017	BJN ANH PİPO TRNV UÇ 17	326,75	118	7050290622	BTR ÇEK YP KOL 6X6	150,00	245
1940090019	BJN ANH PİPO TRNV UÇ 19	345,25	118	7050290822	BTR ÇEK YP KOL 8X8	171,75	245
1940090021	BJN ANH PİPO TRNV UÇ 21	373,00	118	7050290444	BTR ÇEK YP MİL 6X4	199,00	245
8790008106	BKM ONRM SET5	1.970,75	62	7050290644	BTR ÇEK YP MİL 6X6	222,50	245
8793001014	BKM SET14	2.132,50	63	7050290844	BTR ÇEK YP MİL 8X8	280,25	245
13000005117	BLACK LINE DÜZ UÇ KRGB 180	878,75	138	8550346001	BYK SRV ARB	9.553,50	53
13000005116	BLACK LINE DÜZ UÇ TRNV 6X100	176,00	167	0370020006	BYN KMB ANH 06	95,25	82
13000005118	BLACK LINE KMB PNS 180	740,50	137	0370020007	BYN KMB ANH 07	101,25	82
13000005133	BLACK LINE SET5	2.892,25	141	0370020008	BYN KMB ANH 08	109,50	82
13000005120	BLACK LINE YLD UÇ TRNV 6X100	196,25	167	0370020009	BYN KMB ANH 09	112,00	82
13000005119	BLACK LINE YNKS 160	901,00	140	0370020010	BYN KMB ANH 10	127,00	82
6850281322	BORU KSC YP BÇK	137,00	244	0370020011	BYN KMB ANH 11	130,50	82
0550050100	BORU UZT YLD ANH 100		89	0370020012	BYN KMB ANH 12	139,75	82
0550050022	BORU UZT YLD ANH 22		89	0370020013	BYN KMB ANH 13	143,25	82
0550050024	BORU UZT YLD ANH 24	498,75	89	0370020014	BYN KMB ANH 14	153,75	82
0550050027	BORU UZT YLD ANH 27	594,75	89	0370020015	BYN KMB ANH 15	163,75	82
0550050030	BORU UZT YLD ANH 30	710,00	89	0370020016	BYN KMB ANH 16	175,50	82
0550050032	BORU UZT YLD ANH 32	815,25	89	0370020017	BYN KMB ANH 17	187,75	82
0550050034	BORU UZT YLD ANH 34		89	0370020018	BYN KMB ANH 18	209,00	82
0550050036	BORU UZT YLD ANH 36	922,00	89	0370020019	BYN KMB ANH 19	220,00	82
0550050038	BORU UZT YLD ANH 38	1.063,75	89	0370020020	BYN KMB ANH 20	230,75	82
0550050041	BORU UZT YLD ANH 41	1.205,00	89	0370020021	BYN KMB ANH 21	259,75	82
0550050046	BORU UZT YLD ANH 46	1.441,25	89	0370020022	BYN KMB ANH 22	297,50	82
0550050050	BORU UZT YLD ANH 50	1.701,75	89	0370020023	BYN KMB ANH 23	363,00	82
0550050055	BORU UZT YLD ANH 55	2.393,25	89	0370020024	BYN KMB ANH 24	363,00	82
0550050060	BORU UZT YLD ANH 60	2.597,25	89	0370020025	BYN KMB ANH 25	363,00	82
0550050065	BORU UZT YLD ANH 65	2.812,50	89	0370020026	BYN KMB ANH 26	427,25	82
0550050070	BORU UZT YLD ANH 70		89	0370020027	BYN KMB ANH 27	427,25	82
0550050075	BORU UZT YLD ANH 75		89	0370020028	BYN KMB ANH 28	427,25	82
0550050080	BORU UZT YLD ANH 80		89	0370020029	BYN KMB ANH 29	475,75	82
0550050085	BORU UZT YLD ANH 85		89	0370020030	BYN KMB ANH 30	490,75	82
0550050090	BORU UZT YLD ANH 90		89	0370020032	BYN KMB ANH 32	514,75	82
0550050095	BORU UZT YLD ANH 95		89	0370020036	BYN KMB ANH 36	595,00	82
14000004133	BTKÇ BYK	1.697,75	67	0370002112	BYN KMB ANH TK12	1.960,25	82
14000004134	BTKÇ KÇK	1.049,25	68	0370002117	BYN KMB ANH TK17	2.856,25	82
14000004135	BTKÇ ORTA	1.618,75	67	0370002121	BYN KMB ANH TK21	4.652,00	82
3830150225	BTN KRPTN 225	570,75	149	0370002108	BYN KMB ANH TK8	1.096,00	82
3832150225	BTN KRPTN 225 ELTA	478,00	235	0340020008	CRC KMB ANH 08	398,75	80
3830150250	BTN KRPTN 250	630,50	149	0340020009	CRC KMB ANH 09	397,75	80
3832150250	BTN KRPTN 250 ELTA	545,00	235	0340020010	CRC KMB ANH 10	417,00	80
3830150280	BTN KRPTN 280	752,75	149	0340020011	CRC KMB ANH 11	419,25	80
3832150280	BTN KRPTN 280 ELTA	653,50	235	0340020012	CRC KMB ANH 12	454,75	80
3831150280	BTN KRPTN YAY 280	755,25	149	0340020013	CRC KMB ANH 13	486,75	80
7050290604	BTR ÇEK 2KOL 6X4	778,50	222	0340020014	CRC KMB ANH 14	501,50	80
7050290606	BTR ÇEK 2KOL 6X6	802,75	222	0340020015	CRC KMB ANH 15	531,50	80
7050290808	BTR ÇEK 2KOL 8X8	843,25	222	0340020016	CRC KMB ANH 16	609,00	80



KOD	ÜRÜN	FİYAT	SAYFA	KOD	ÜRÜN	FİYAT	SAYFA
0340020017	CRC KMB ANH 17	644,75	80	0700050095	ÇTL ÇAK ANH 95	7.132,25	88
0340020018	CRC KMB ANH 18	699,00	80	8786001003	DĞD SET3	2.921,50	63
0340020019	CRC KMB ANH 19	742,00	80	4815006107	DĞŞK BİTS UÇ TRNV SET7	343,00	174
0340020021	CRC KMB ANH 21	1.032,50	80	4240170680	DĞŞK UÇ TRNV 6X80	160,25	169
0340020022	CRC KMB ANH 22	1.132,25	80	4170170680	DĞŞK UÇ TRNV 6X80 ELTA	139,50	235
0340020024	CRC KMB ANH 24	1.279,00	80	4240007102	DĞŞK UÇ TRNV TK2	274,75	169
0340002110	CRC KMB ANH TK10	4.994,00	80	7122291275	DIŞ RLM ÇEK ÇENE 12-75	3.093,25	225
0340002115	CRC KMB ANH TK15	9.745,75	80	7122292211	DIŞ RLM ÇEK ÇENE 22-115	4.829,25	225
13000005343	CRC KMB ANH TK4	2.290,50	80	7122292515	DIŞ RLM ÇEK ÇENE 25-155	7.560,00	225
13000005278	CRC MNY BİTS TUTC TRNV 50	378,25	175	7122293022	DIŞ RLM ÇEK ÇENE 30-220	20.659,25	225
13000005429	CRC MNY BİTS TUTC TRNV SET8	637,00	175	7122294028	DIŞ RLM ÇEK ÇENE 40-280	46.142,25	225
2511110280	CTİP AYR PNS 280	1.430,75	135	7122290560	DIŞ RLM ÇEK ÇENE 5-60	2.469,00	225
7010316105	ÇEK SHP	645,75	248	7122291036	DIŞ RLM ÇEK KOL 100-360	21.219,75	225
7010006105	ÇEK&SHP SET6	16.847,00	221	7122291443	DIŞ RLM ÇEK KOL 140-435	41.474,50	225
6730270550	ÇİM KSM MKS DÜZ AĞZ 550 ELTA	583,25	239	7122294011	DIŞ RLM ÇEK KOL 40-115	4.601,25	225
6731270650	ÇİM KSM MKS EĞRİ AĞZ 650 ELTA	1.042,00	239	7122295520	DIŞ RLM ÇEK KOL 55-205	7.283,50	225
8320331001	ÇKM ALET SND KRMZ450	7.938,00	58	7122299026	DIŞ RLM ÇEK KOL 90-260	10.311,50	225
8320331003	ÇKM ALET SND KRMZ650	8.686,00	58	4776008107	DLK TORX UÇ TRNV TK7	1.420,25	173
13000005560	ÇKM2 SRV ARB	11.510,00	52	4776180010	DLK TORX UÇ TRNV TR10	154,50	173
0335020010	ÇOK YLD CRC ANH 10X13X17X19	1.476,25	81	4776180015	DLK TORX UÇ TRNV TR15	154,50	173
0700050100	ÇTL ÇAK ANH 100	10.108,25	88	4776180020	DLK TORX UÇ TRNV TR20	172,25	173
0700050105	ÇTL ÇAK ANH 105	10.423,50	88	4776180025	DLK TORX UÇ TRNV TR25	198,50	173
0700050110	ÇTL ÇAK ANH 110	11.893,25	88	4776180027	DLK TORX UÇ TRNV TR27	219,00	173
0700050115	ÇTL ÇAK ANH 115	13.662,00	88	4776180030	DLK TORX UÇ TRNV TR30	233,00	173
0700050120	ÇTL ÇAK ANH 120	14.421,00	88	4776180040	DLK TORX UÇ TRNV TR40	288,50	173
0700050125	ÇTL ÇAK ANH 125		88	4776180009	DLK TORX UÇ TRNV TR9	149,25	173
0700050130	ÇTL ÇAK ANH 130		88	3852240225	DLK ZMB 225	653,50	144
0700050135	ÇTL ÇAK ANH 135		88	8502346002	DMNT ATLY MASA	61.101,75	56
0700050140	ÇTL ÇAK ANH 140		88	8550348001	DMNT KÇK SRV ARB	5.752,75	52
0700050145	ÇTL ÇAK ANH 145		88	8545341005	DMNT TARB	17.428,25	53
0700050150	ÇTL ÇAK ANH 150		88	2350270018	DMR KSM MKS 18"	1.736,00	213
0700050024	ÇTL ÇAK ANH 24	340,75	88	2350270024	DMR KSM MKS 24"	2.555,00	213
0700050027	ÇTL ÇAK ANH 27	422,75	88	2350270030	DMR KSM MKS 30"	3.999,50	213
0700050030	ÇTL ÇAK ANH 30	519,00	88	2350270036	DMR KSM MKS 36"	5.176,25	213
0700050032	ÇTL ÇAK ANH 32	582,50	88	2350316104	DMR KSM MKS SHP	3.073,50	248
0700050036	ÇTL ÇAK ANH 36	654,00	88	2350270118	DMR KSM MKS YP ÇENE 18"	943,50	242
0700050038	ÇTL ÇAK ANH 38	787,50	88	2350270124	DMR KSM MKS YP ÇENE 24"	1.081,50	242
0700050041	ÇTL ÇAK ANH 41	855,00	88	2350270130	DMR KSM MKS YP ÇENE 30"	1.913,75	242
0700050042	ÇTL ÇAK ANH 42	988,00	88	2350270136	DMR KSM MKS YP ÇENE 36"	3.533,50	242
0700050046	ÇTL ÇAK ANH 46	1.087,50	88	2350006104	DMR KSM MKS&SHP SET5	16.540,25	213
0700050047	ÇTL ÇAK ANH 47	1.270,00	88	0551050001	DNDR KOL BORU 22-30	466,50	89
0700050050	ÇTL ÇAK ANH 50	1.358,50	88	0551050002	DNDR KOL BORU 32-41	632,00	89
0700050055	ÇTL ÇAK ANH 55	1.820,75	88	0551050003	DNDR KOL BORU 46-55	947,50	89
0700050060	ÇTL ÇAK ANH 60	1.976,75	88	0551050004	DNDR KOL BORU 60-100	1.278,25	89
0700050065	ÇTL ÇAK ANH 65	2.843,25	88	3850120200	DNLY 200	929,75	149
0700050070	ÇTL ÇAK ANH 70	3.639,25	88	4810200645	DÜZ BİTS UÇ 0,6X4,5(25)	17,25	176
0700050075	ÇTL ÇAK ANH 75	3.856,00	88	4810205645	DÜZ BİTS UÇ 0,6X4,5(50)	28,50	176
0700050080	ÇTL ÇAK ANH 80	4.903,25	88	4810200855	DÜZ BİTS UÇ 0,8X5,5(25)	17,25	176
0700050085	ÇTL ÇAK ANH 85	6.500,00	88	4810205855	DÜZ BİTS UÇ 0,8X5,5(50)	28,50	176
0700050090	ÇTL ÇAK ANH 90	6.687,75	88	4810201265	DÜZ BİTS UÇ 1,2X6,5(25)	17,25	176

KOD	ÜRÜN	FİYAT	SAYFA	KOD	ÜRÜN	FİYAT	SAYFA
4810205265	DÜZ BİTS UÇ 1,2X6,5(50)	28,50	176	3553140150	ELKTRO DÜZ UÇ KRGB 150	575,25	147
4860201045	DÜZ BİTS UÇ 4,5(100)	64,50	176	3565002104	ELKTRO KRGB SET4	2.303,00	148
4860201545	DÜZ BİTS UÇ 4,5(150)	91,75	176	3554140150	ELKTRO KRGB UB 150	575,25	147
4860200745	DÜZ BİTS UÇ 4,5(75)	42,75	176	3560002104	ELKTRO KSK&PNS SET4	2.385,00	148
4860201055	DÜZ BİTS UÇ 5,5(100)	64,50	176	3557140125	ELKTRO PNS 125	577,25	148
4860201555	DÜZ BİTS UÇ 5,5(150)	91,75	176	3555140150	ELKTRO SVR UÇ DÜZ KRGB 150	575,25	147
4860200755	DÜZ BİTS UÇ 5,5(75)	42,75	176	3556140150	ELKTRO SVR UÇ EĞRİ KRGB 150	575,25	148
4860201065	DÜZ BİTS UÇ 6,5(100)	64,50	176	3551140125	ELKTRO TPKSK 125	595,00	147
4860201565	DÜZ BİTS UÇ 6,5(150)	91,75	176	3550140125	ELKTRO YNKSK 125	637,50	147
4860200765	DÜZ BİTS UÇ 6,5(75)	42,75	176	3552140125	ELKTRO YVRL UÇ KRGB 125	577,25	147
4810000645	DÜZ BİTS UÇ TK10 0,6X4,5	172,50	176	6712270210	ELMA MKS 210	1.094,50	216
4810000855	DÜZ BİTS UÇ TK10 0,8X5,5	172,50	176	14000005046	ELTA ERGO KLT MKT BÇK SET2	182,75	240
4810001265	DÜZ BİTS UÇ TK10 1,2X6,5	172,50	176	5810251000	EMNY ÇKÇ 1000GR	797,25	190
5500230100	DÜZ KSK 100	149,25	187	5810251500	EMNY ÇKÇ 1500GR	1.103,00	190
5500230125	DÜZ KSK 125	179,75	187	5810252000	EMNY ÇKÇ 2000GR	1.362,25	190
5500230150	DÜZ KSK 150	230,75	187	14000005044	ERGO KLT MKT BÇK 18 ELTA	115,50	240
5500230175	DÜZ KSK 175	260,00	187	14000005045	ERGO KLT MKT BÇK 9 ELTA	67,25	240
5500230200	DÜZ KSK 200	362,25	187	2401110240	FORT PNS 240 ELTA	661,00	234
5500230250	DÜZ KSK 250	445,00	187	2415110240	FORT PNS YAY 240	969,25	134
5500230300	DÜZ KSK 300	712,75	187	6230260300	GRES POMP KAVAL BORU 300CC	719,75	199
5500231250	DÜZ KSK KLKN İZL 250	566,25	187	6230260500	GRES POMP KAVAL BORU 500CC	886,25	199
5500231300	DÜZ KSK KLKN İZL 300	825,00	187	6230263300	GRES POMP YP HRTM 300CC	94,25	244
5550240002	DÜZ PİM ZMB 02	213,25	188	6230263500	GRES POMP YP HRTM 500CC	172,25	244
5550240003	DÜZ PİM ZMB 03	213,25	188	6230262500	GRES POMP YP UÇ 300&500CC	82,75	244
5550240004	DÜZ PİM ZMB 04	216,50	188	14000005138	HASAT MKS PASZ ÇLK DÜZ AĞZ	442,25	217
5550240005	DÜZ PİM ZMB 05	216,50	188	3420120220	HRTM KLÇ PNS 220	933,50	144
5550240006	DÜZ PİM ZMB 06	218,25	188	0589850283	HSS TSTR YP LAMA 13X0,65X18	87,75	244
5550240007	DÜZ PİM ZMB 07	227,50	188	5010230006	ISKPL DÜZ 06	249,25	187
5550240008	DÜZ PİM ZMB 08	243,25	188	5011230006	ISKPL DÜZ 06 ELTA	206,50	238
5550240009	DÜZ PİM ZMB 09	246,75	188	5010230008	ISKPL DÜZ 08	266,25	187
5550240010	DÜZ PİM ZMB 10	249,25	188	5011230008	ISKPL DÜZ 08 ELTA	219,00	238
5550240105	DÜZ PİM ZMB KKPL 05	190,25	188	5010230010	ISKPL DÜZ 10	281,00	187
5550001006	DÜZ PİM ZMB TK6	1.335,25	188	5011230010	ISKPL DÜZ 10 ELTA	231,25	238
3301120140	DÜZ UÇ DIŞ SGM PNS YAY 140	525,25	143	5010230012	ISKPL DÜZ 12	308,25	187
3301120180	DÜZ UÇ DIŞ SGM PNS YAY 180	554,00	143	5011230012	ISKPL DÜZ 12 ELTA	253,75	238
3301120225	DÜZ UÇ DIŞ SGM PNS YAY 225	692,00	143	5010230014	ISKPL DÜZ 14	318,75	187
3301120295	DÜZ UÇ DIŞ SGM PNS YAY 295	1.173,00	143	5011230014	ISKPL DÜZ 14 ELTA	262,75	238
3321120140	DÜZ UÇ İÇ SGM PNS YAYZ 140	483,75	143	5010230016	ISKPL DÜZ 16	341,00	187
3321120180	DÜZ UÇ İÇ SGM PNS YAYZ 180	510,25	143	5011230016	ISKPL DÜZ 16 ELTA	280,50	238
3321120225	DÜZ UÇ İÇ SGM PNS YAYZ 225	635,00	143	5010230018	ISKPL DÜZ 18	369,75	187
3321120310	DÜZ UÇ İÇ SGM PNS YAYZ 310	1.089,50	143	5011230018	ISKPL DÜZ 18 ELTA	304,50	238
13000005122	DVM TEL KSM MKS 210	1.297,25	215	5010230020	ISKPL DÜZ 20	411,25	187
3311120125	EĞRİ UÇ DIŞ SGM PNS YAY 125	587,00	143	5011230020	ISKPL DÜZ 20 ELTA	337,50	238
3311120170	EĞRİ UÇ DIŞ SGM PNS YAY 170	618,00	143	5010230022	ISKPL DÜZ 22	445,50	187
3311120210	EĞRİ UÇ DIŞ SGM PNS YAY 210	710,50	143	5011230022	ISKPL DÜZ 22 ELTA	367,00	238
3311120275	EĞRİ UÇ DIŞ SGM PNS YAY 275	1.231,75	143	5010230024	ISKPL DÜZ 24	481,50	187
3331120130	EĞRİ UÇ İÇ SGM PNS YAYZ 130	520,00	143	5011230024	ISKPL DÜZ 24 ELTA	395,25	238
3331120170	EĞRİ UÇ İÇ SGM PNS YAYZ 170	547,50	143	5010230026	ISKPL DÜZ 26	498,75	187
3331120210	EĞRİ UÇ İÇ SGM PNS YAYZ 210	683,00	143	5011230026	ISKPL DÜZ 26 ELTA	410,25	238
3331120290	EĞRİ UÇ İÇ SGM PNS YAYZ 290	1.172,00	143	5010230030	ISKPL DÜZ 30	532,50	187



KOD	ÜRÜN	FİYAT	SAYFA	KOD	ÜRÜN	FİYAT	SAYFA
5011230030	ISKPL DÜZ 30 ELTA	437,75	238	4530171060	KLMNS TORX UÇ TRNV T10	100,25	170
5010008106	ISKPL TK6	2.030,00	187	4530170560	KLMNS TORX UÇ TRNV T5	96,75	170
7120293575	İÇ RLM ÇEK KOL 35-75	1.626,75	224	4530170660	KLMNS TORX UÇ TRNV T6	96,75	170
7120296013	İÇ RLM ÇEK KOL 60-130	3.295,75	224	4530170760	KLMNS TORX UÇ TRNV T7	100,25	170
7120291013	İÇ RLM ÇEK PENS 10-13 MDL-A	1.479,75	224	4530170860	KLMNS TORX UÇ TRNV T8	100,25	170
7120291317	İÇ RLM ÇEK PENS 13-17 MDL-A	1.479,75	224	4530170960	KLMNS TORX UÇ TRNV T9	100,25	170
7120291419	İÇ RLM ÇEK PENS 14-19 MDL-A	1.516,00	224	4530001006	KLMNS TORX UÇ TRNV TK6	594,50	170
7120291621	İÇ RLM ÇEK PENS 16-21 MDL-A	1.516,00	224	4520180360	KLMNS YLD UÇ TRNV 3X60	83,75	169
7120291823	İÇ RLM ÇEK PENS 18-23 MDL-A	1.814,50	224	4520184150	KLMNS YLD UÇ TRNV 4X150	160,00	169
7120292025	İÇ RLM ÇEK PENS 20-25 MDL-A	1.915,50	224	4520180480	KLMNS YLD UÇ TRNV 4X80	120,00	169
7120292530	İÇ RLM ÇEK PENS 25-30 MDL-A	1.995,50	224	0637550010	KLPÇ AYR YAĞ FLT SÖKM 100	103,75	243
7120292540	İÇ RLM ÇEK PENS 25-40 MDL-B	3.233,25	224	0320020005	KMB ANH KB 05	79,75	77
7120293037	İÇ RLM ÇEK PENS 30-37 MDL-A	2.311,25	224	0320020006	KMB ANH KB 06	82,75	77
7120293542	İÇ RLM ÇEK PENS 35-42 MDL-A	2.429,25	224	0320020007	KMB ANH KB 07	87,75	77
7120293845	İÇ RLM ÇEK PENS 38-45 MDL-A	2.560,75	224	0320020008	KMB ANH KB 08	95,75	77
7120294350	İÇ RLM ÇEK PENS 43-50 MDL-A	2.911,75	224	0320020009	KMB ANH KB 09	97,75	77
7120290507	İÇ RLM ÇEK PENS 5-7 MDL-A	1.597,00	224	0320020010	KMB ANH KB 10	110,25	77
7120290709	İÇ RLM ÇEK PENS 7-9 MDL-A	1.597,00	224	0320020011	KMB ANH KB 11	113,00	77
7120290912	İÇ RLM ÇEK PENS 9-12 MDL-A	1.479,75	224	0320020012	KMB ANH KB 12	120,75	77
7300301012	İŞKN 100X12	1.626,00	205	0320020013	KMB ANH KB 13	123,25	77
7300303012	İŞKN 30X12	1.062,75	205	0320020014	KMB ANH KB 14	133,50	77
7300304012	İŞKN 40X12	1.255,75	205	0320020015	KMB ANH KB 15	142,25	77
7300305012	İŞKN 50X12	1.287,25	205	0320020016	KMB ANH KB 16	153,00	77
7300306012	İŞKN 60X12	1.343,50	205	0320020017	KMB ANH KB 17	163,50	77
7300308012	İŞKN 80X12	1.425,00	205	0320020018	KMB ANH KB 18	181,50	77
7300316150	İŞKN SHP	2.641,75	248	0320020019	KMB ANH KB 19	191,25	77
13000005248	KAMP BLT 600GR	1.206,00	191	0320020020	KMB ANH KB 20	195,00	77
8550348002	KAPA KÇK DMNT SRV ARB	6.634,25	52	0320020021	KMB ANH KB 21	226,00	77
14000004238	KATLANIR BDM TSTR 120	706,00	196	0320020022	KMB ANH KB 22	257,50	77
0375250625	KBLO SYRC (T 6/300 - Ç 1,5/25)	504,25	195	0320020023	KMB ANH KB 23	257,50	77
0375050020	KBLO SYRC 8-28	554,00	195	0320020024	KMB ANH KB 24	316,00	77
0375550625	KBLO SYRC YP BÇK	127,75	243	0320020025	KMB ANH KB 25	316,00	77
6850280322	KÇK BORU KSC	510,25	218	0320020026	KMB ANH KB 26	372,00	77
7310301005	KÇK İŞKN 10X5	457,50	205	0320020027	KMB ANH KB 27	372,00	77
7310301505	KÇK İŞKN 15X5	481,75	205	0320020028	KMB ANH KB 28	372,00	77
7310302005	KÇK İŞKN 20X5	499,75	205	0320020029	KMB ANH KB 29	425,75	77
7310302505	KÇK İŞKN 25X5	521,00	205	0320020030	KMB ANH KB 30	425,75	77
7310303005	KÇK İŞKN 30X5	539,50	205	0320020032	KMB ANH KB 32	447,25	77
4540190190	KLİPS SÖKM TRNV	376,50	170	0320020034	KMB ANH KB 34	467,50	77
4500172560	KLMNS DÜZ UÇ TRNV 2,5X60	71,25	169	0320020055	KMB ANH KB 5,5	79,75	77
4500172580	KLMNS DÜZ UÇ TRNV 2,5X80	74,75	169	0320002112	KMB ANH KB TK12	1.701,75	77
4500173510	KLMNS DÜZ UÇ TRNV 3,5X100	99,50	169	0320002117	KMB ANH KB TK17	2.474,75	77
4500173100	KLMNS DÜZ UÇ TRNV 3X100	96,75	169	0320002121	KMB ANH KB TK21	4.035,75	77
4500173125	KLMNS DÜZ UÇ TRNV 3X125	127,75	169	0320002108	KMB ANH KB TK8	952,25	77
4500170380	KLMNS DÜZ UÇ TRNV 3X80	79,25	169	0350020006	KMB ANH SB 06 ELTA	69,00	229
4500174100	KLMNS DÜZ UÇ TRNV 4X100	99,50	169	0350020007	KMB ANH SB 07 ELTA	73,50	229
4500174125	KLMNS DÜZ UÇ TRNV 4X125	134,00	169	0350020008	KMB ANH SB 08 ELTA	79,25	229
4500174150	KLMNS DÜZ UÇ TRNV 4X150	145,75	169	0350020009	KMB ANH SB 09 ELTA	81,75	229
4500170480	KLMNS DÜZ UÇ TRNV 4X80	81,50	169	0350020010	KMB ANH SB 10 ELTA	92,25	229
4500008106	KLMNS DÜZ&YLD UÇ TRNV SET6	653,25	169	0350020011	KMB ANH SB 11 ELTA	95,25	229

KOD	ÜRÜN	FİYAT	SAYFA	KOD	ÜRÜN	FİYAT	SAYFA
0350020012	KMB ANH SB 12 ELTA	101,25	229	0331020015	KMB ANH UB 19/32 SAE	200,75	79
0350020013	KMB ANH SB 13 ELTA	102,75	229	0331020050	KMB ANH UB 2 SAE		79
0350020014	KMB ANH SB 14 ELTA	111,00	229	0330020020	KMB ANH UB 20	226,25	78
0350020015	KMB ANH SB 15 ELTA	118,50	229	0330020021	KMB ANH UB 21	241,00	78
0350020016	KMB ANH SB 16 ELTA	127,75	229	0330020022	KMB ANH UB 22	287,25	78
0350020017	KMB ANH SB 17 ELTA	136,25	229	0330020023	KMB ANH UB 23	350,00	78
0350020018	KMB ANH SB 18 ELTA	151,25	229	0330020024	KMB ANH UB 24	350,00	78
0350020019	KMB ANH SB 19 ELTA	159,25	229	0330020025	KMB ANH UB 25	350,00	78
0350020020	KMB ANH SB 20 ELTA	162,50	229	0331020020	KMB ANH UB 25/32 SAE	286,00	79
0350020021	KMB ANH SB 21 ELTA	188,50	229	0330020026	KMB ANH UB 26	412,25	78
0350020022	KMB ANH SB 22 ELTA	215,50	229	0330020027	KMB ANH UB 27	412,25	78
0350020024	KMB ANH SB 24 ELTA	263,25	229	0330020028	KMB ANH UB 28	412,25	78
0350020027	KMB ANH SB 27 ELTA	309,75	229	0330020029	KMB ANH UB 29	412,25	78
0350020030	KMB ANH SB 30 ELTA	355,50	229	0331020005	KMB ANH UB 3/16 SAE	110,25	79
0350020032	KMB ANH SB 32 ELTA	372,75	229	0331020019	KMB ANH UB 3/4 SAE	267,75	79
0350002112	KMB ANH SB TK12 ELTA	1.420,75	229	0331020010	KMB ANH UB 3/8 SAE	152,25	79
0350002117	KMB ANH SB TK17 ELTA	2.065,50	229	0330020030	KMB ANH UB 30	473,50	78
0350002121	KMB ANH SB TK21 ELTA	3.366,75	229	0330020032	KMB ANH UB 32	496,25	78
0350002108	KMB ANH SB TK8 ELTA	794,00	229	0330020034	KMB ANH UB 34	506,00	78
0330020005	KMB ANH UB 05	92,25	78	0330020036	KMB ANH UB 36	573,25	78
0330020006	KMB ANH UB 06	92,25	78	0330020038	KMB ANH UB 38	586,75	78
0330020007	KMB ANH UB 07	92,25	78	0330020041	KMB ANH UB 41	667,75	78
0330020008	KMB ANH UB 08	107,50	78	0330020046	KMB ANH UB 46	906,75	78
0330020009	KMB ANH UB 09	109,25	78	0330020055	KMB ANH UB 5,5	92,25	78
0331020025	KMB ANH UB 1 SAE	445,00	79	0331020008	KMB ANH UB 5/16 SAE	133,50	79
0331020013	KMB ANH UB 1/2 SAE	180,25	79	0331020016	KMB ANH UB 5/8 SAE	215,50	79
0331020006	KMB ANH UB 1/4 SAE	115,25	79	0330020050	KMB ANH UB 50	1.229,25	78
0330020010	KMB ANH UB 10	120,75	78	0331020011	KMB ANH UB 7/16 SAE	160,00	79
0330020011	KMB ANH UB 11	127,75	78	0331020022	KMB ANH UB 7/8 SAE	363,50	79
0331020017	KMB ANH UB 11/16 SAE	229,75	79	0331020014	KMB ANH UB 9/16 SAE	189,25	79
0331020027	KMB ANH UB 1-1/16 SAE	520,75	79	0330002112	KMB ANH UB TK12	1.885,75	78
0331020038	KMB ANH UB 1-1/2 SAE	755,25	79	0331002112	KMB ANH UB TK12 SAE	3.097,75	79
0331020032	KMB ANH UB 1-1/4 SAE	625,00	79	0330002117	KMB ANH UB TK17	2.733,50	78
0331020028	KMB ANH UB 1-1/8 SAE	520,75	79	0331002117	KMB ANH UB TK17 SAE	4.816,50	79
0331020046	KMB ANH UB 1-13/16 SAE		79	0331002120	KMB ANH UB TK20 SAE	6.587,25	79
0330020012	KMB ANH UB 12	127,75	78	0330002121	KMB ANH UB TK21	4.465,50	78
0330020013	KMB ANH UB 13	143,00	78	0330002108	KMB ANH UB TK8	1.059,75	78
0331020021	KMB ANH UB 13/16 SAE	316,00	79	0331002108	KMB ANH UB TK8 SAE	1.528,25	79
0331020030	KMB ANH UB 1-3/16 SAE	596,00	79	6740270140	KMB MKS 140	641,25	215
0331020035	KMB ANH UB 1-3/8 SAE		79	6740270190	KMB MKS 190	752,00	215
0330020014	KMB ANH UB 14	148,50	78	0588750150	KMPS 150	1.944,50	196
0330020015	KMB ANH UB 15	159,00	78	0860052528	KNC ANH 4GEN UÇ 25/28	244,75	90
0331020024	KMB ANH UB 15/16 SAE	445,00	79	0860053032	KNC ANH 4GEN UÇ 30/32	244,75	90
0331020033	KMB ANH UB 1-5/16 SAE	625,00	79	0860053436	KNC ANH 4GEN UÇ 34/36	264,50	90
0331020041	KMB ANH UB 1-5/8 SAE		79	0860054042	KNC ANH 4GEN UÇ 40/42	264,50	90
0330020016	KMB ANH UB 16	160,25	78	0860054550	KNC ANH 4GEN UÇ 45/50	306,25	90
0330020017	KMB ANH UB 17	181,50	78	0860055255	KNC ANH 4GEN UÇ 52/55	306,25	90
0331020036	KMB ANH UB 1-7/16 SAE		79	0860055862	KNC ANH 4GEN UÇ 58/62	369,50	90
0330020018	KMB ANH UB 18	196,00	78	0860056875	KNC ANH 4GEN UÇ 68/75	369,50	90
0330020019	KMB ANH UB 19	213,25	78	0860058090	KNC ANH 4GEN UÇ 80/90	482,50	90



KOD	ÜRÜN	FIYAT	SAYFA	KOD	ÜRÜN	FIYAT	SAYFA
0860059510	KNC ANH 4GEN UÇ 95/100	482,50	90	4100178200	KRAFT DÜZ UÇ TRNV 8X200	272,25	164
5545240002	KNK PİM ZMB 02	148,75	188	4100179200	KRAFT DÜZ UÇ TRNV 9X200	290,00	164
5545240003	KNK PİM ZMB 03	161,75	188	4100008108	KRAFT DÜZ UÇ TRNV TK8	963,25	164
5545240004	KNK PİM ZMB 04	182,25	188	4100008107	KRAFT DÜZ&YLD UÇ TRNV SET7	855,25	165
5545240005	KNK PİM ZMB 05	185,75	188	3225133160	KRAFT EĞRİ UÇ KRGB 160	632,00	139
5545240006	KNK PİM ZMB 06	273,50	188	3225133180	KRAFT EĞRİ UÇ KRGB 180	694,00	139
5545240007	KNK PİM ZMB 07	285,00	188	3225133200	KRAFT EĞRİ UÇ KRGB 200	763,25	139
5545240008	KNK PİM ZMB 08	295,75	188	3020123160	KRAFT KMB PNS 160	547,50	137
5545240009	KNK PİM ZMB 09	302,75	188	3020123180	KRAFT KMB PNS 180	611,50	137
5545240010	KNK PİM ZMB 10	309,00	188	3020123200	KRAFT KMB PNS 200	691,00	137
5545240012	KNK PİM ZMB 12	323,00	188	4110175525	KRAFT TPÇ DÜZ UÇ TRNV 5,5X25	90,75	166
5545240103	KNK PİM ZMB KKPL 03	169,25	188	4110175540	KRAFT TPÇ DÜZ UÇ TRNV 5,5X40	122,50	166
4550170135	KNT KLM DÜZ UÇ 135	93,50	163	4110176525	KRAFT TPÇ DÜZ UÇ TRNV 6,5X25	101,25	166
4550170190	KNT KLM DÜZ UÇ 190	119,75	163	4110176540	KRAFT TPÇ DÜZ UÇ TRNV 6,5X40	138,75	166
4560180135	KNT KLM YLD UÇ 135	103,75	163	4130184525	KRAFT TPÇ YLD UÇ TRNV 4,5X25	96,75	166
4560180190	KNT KLM YLD UÇ 190	141,50	163	4130184540	KRAFT TPÇ YLD UÇ TRNV 4,5X40	122,00	166
0375150012	KOAK KBLO SYRC	718,75	195	4130180625	KRAFT TPÇ YLD UÇ TRNV 6X25	101,50	166
2515110270	KPRT AYR PNS 270	1.146,25	136	4130180640	KRAFT TPÇ YLD UÇ TRNV 6X40	137,50	166
6210270250	KPRT MKS 250 SAĞ YAY	863,00	214	4120181200	KRAFT YLD UÇ TRNV 10X200	449,00	165
6211270250	KPRT MKS 250 SOL YAY	863,00	214	4120180360	KRAFT YLD UÇ TRNV 3X60	88,75	165
6210270275	KPRT MKS 275 SAĞ YAY	944,00	214	4120185100	KRAFT YLD UÇ TRNV 4,5X100	142,00	165
6211270275	KPRT MKS 275 SOL YAY	944,00	214	4120185150	KRAFT YLD UÇ TRNV 4,5X150	169,75	165
6210270300	KPRT MKS 300 SAĞ YAY	1.076,00	214	4120185300	KRAFT YLD UÇ TRNV 4,5X300	400,75	165
6211270300	KPRT MKS 300 SOL YAY	1.076,00	214	4120184580	KRAFT YLD UÇ TRNV 4,5X80	127,75	165
3220133140	KRAFT DÜZ UÇ KRGB 140	543,25	138	4120186100	KRAFT YLD UÇ TRNV 6X100	153,25	165
3220133160	KRAFT DÜZ UÇ KRGB 160	613,00	138	4120186150	KRAFT YLD UÇ TRNV 6X150	183,50	165
3220133180	KRAFT DÜZ UÇ KRGB 180	674,50	138	4120186200	KRAFT YLD UÇ TRNV 6X200	238,25	165
3220133200	KRAFT DÜZ UÇ KRGB 200	715,00	138	4120186300	KRAFT YLD UÇ TRNV 6X300	414,25	165
4100171125	KRAFT DÜZ UÇ TRNV 11X250	368,50	164	4120188150	KRAFT YLD UÇ TRNV 8X150	290,75	165
4100170340	KRAFT DÜZ UÇ TRNV 3X40	78,75	164	4120008106	KRAFT YLD UÇ TRNV TK6	865,00	165
4100170380	KRAFT DÜZ UÇ TRNV 3X80	83,75	164	3700163140	KRAFT YNKSK 140	561,00	140
4100174100	KRAFT DÜZ UÇ TRNV 4X100	104,75	164	3700163160	KRAFT YNKSK 160	673,50	140
4100174300	KRAFT DÜZ UÇ TRNV 4X300	256,50	164	3700163180	KRAFT YNKSK 180	784,50	140
4100170480	KRAFT DÜZ UÇ TRNV 4X80	90,25	164	0588150013	KROM ŞRT MT3	266,75	195
4100175100	KRAFT DÜZ UÇ TRNV 5X100	121,50	164	0588150015	KROM ŞRT MT5	301,00	195
4100175125	KRAFT DÜZ UÇ TRNV 5X125	138,75	164	3800150160	KRPTN 160	459,75	149
4100175150	KRAFT DÜZ UÇ TRNV 5X150	152,00	164	3801150160	KRPTN 160 ELTA	372,00	235
4100175250	KRAFT DÜZ UÇ TRNV 5X250	287,25	164	3800150180	KRPTN 180	475,75	149
4100175350	KRAFT DÜZ UÇ TRNV 5X350	323,75	164	3801150180	KRPTN 180 ELTA	401,50	235
4100170580	KRAFT DÜZ UÇ TRNV 5X80	110,75	164	3800150200	KRPTN 200	634,25	149
4100176100	KRAFT DÜZ UÇ TRNV 6X100	124,50	164	3801150200	KRPTN 200 ELTA	501,50	235
4100176125	KRAFT DÜZ UÇ TRNV 6X125	143,00	164	3800150250	KRPTN 250	691,00	149
4100176150	KRAFT DÜZ UÇ TRNV 6X150	156,75	164	5600006106	KSK&ZMB SET6	1.240,25	189
4100176175	KRAFT DÜZ UÇ TRNV 6X175	201,00	164	6400250600	KSR 400GR	805,25	191
4100176350	KRAFT DÜZ UÇ TRNV 6X350	342,75	164	6400250001	KSR YP SAP 400GR	116,25	243
4100177125	KRAFT DÜZ UÇ TRNV 7X125	159,00	164	4912000007	KST ALLEN ANH 1,5-6	546,75	182
4100177150	KRAFT DÜZ UÇ TRNV 7X150	183,50	164	4912003107	KST ALLEN ANH 2,5-10	863,00	182
4100177175	KRAFT DÜZ UÇ TRNV 7X175	210,25	164	4915006106	KST ALLEN ANH 2,5-8 ELTA	546,75	238
4100178150	KRAFT DÜZ UÇ TRNV 8X150	208,75	164	0600011010	KURB ANH 10"	739,25	89
4100178175	KRAFT DÜZ UÇ TRNV 8X175	222,50	164	0601010010	KURB ANH 10" ELTA	614,50	230

KOD	ÜRÜN	FİYAT	SAYFA	KOD	ÜRÜN	FİYAT	SAYFA
0600011012	KURBANH 12"	1.021,50	89	5700002112	KYŞ ZMB TK12	2.356,25	189
0601010012	KURBANH 12" ELTA	812,00	230	4770190040	LKM UÇ TRNV 04	231,25	171
0600011015	KURBANH 15"	1.600,25	89	4770190050	LKM UÇ TRNV 05	231,25	171
0600011006	KURBANH 6"	458,75	89	4770190060	LKM UÇ TRNV 06	231,25	171
0600011008	KURBANH 8"	573,75	89	4770190070	LKM UÇ TRNV 07	248,50	171
0601010008	KURBANH 8" ELTA	408,50	230	4770190080	LKM UÇ TRNV 08	248,50	171
0600010210	KURBANH YP SMN 10"	56,50	242	4770190090	LKM UÇ TRNV 09	268,00	171
0600010212	KURBANH YP SMN 12"	77,25	242	4770190100	LKM UÇ TRNV 10	268,00	171
0600010215	KURBANH YP SMN 15"	111,00	242	4770190110	LKM UÇ TRNV 11	293,00	171
0600010206	KURBANH YP SMN 6"	36,00	242	4770190120	LKM UÇ TRNV 12	314,00	171
0600010208	KURBANH YP SMN 8"	42,50	242	4770190130	LKM UÇ TRNV 13	338,25	171
0600010310	KURBANH YP VİDA 10"	17,25	242	4770190140	LKM UÇ TRNV 14	374,00	171
0600010312	KURBANH YP VİDA 12"	22,75	242	4770190055	LKM UÇ TRNV 5,5	231,25	171
0600010315	KURBANH YP VİDA 15"	28,50	242	4770008108	LKM UÇ TRNV TK8	2.209,50	171
0600010306	KURBANH YP VİDA 6"	9,25	242	5870250400	LSTK ÇKÇ 400GR	766,75	190
0600010308	KURBANH YP VİDA 8"	14,25	242	6350260300	LVY OLK 300	267,00	199
0600010410	KURBANH YP YAY 10"	6,75	242	6350260400	LVY OLK 400	336,75	199
0600010412	KURBANH YP YAY 12"	6,75	242	6351260400	LVY OLK 400 ELTA	257,50	238
0600010415	KURBANH YP YAY 15"	6,75	242	6350260500	LVY OLK 500	467,75	199
0600010406	KURBANH YP YAY 6"	6,75	242	6351260500	LVY OLK 500 ELTA	377,50	238
0600010408	KURBANH YP YAY 8"	6,75	242	6350260600	LVY OLK 600	571,50	199
1850071120	KVN ANH MİL 10X120	85,00	118	6351260600	LVY OLK 600 ELTA	491,75	238
1850071200	KVN ANH MİL 10X200	95,75	118	6360260600	LVY OLK KVRK UÇ 600	631,50	199
1850075125	KVN ANH MİL 5X125	49,00	118	6225260200	MDN YAĞ FLEX UÇ 200CC	297,00	197
1850078180	KVN ANH MİL 8X180	74,75	118	6225260300	MDN YAĞ FLEX UÇ 300CC	334,00	197
0741650001	KVRK UÇ FRÇ PLS SAP 270	101,25	201	6225260500	MDN YAĞ FLEX UÇ 500CC	366,50	197
6800270180	KYM MKS DÜZ 180	700,25	215	5865251000	MDRG 1000GR	731,00	191
6801270180	KYM MKS EĞRİ 180	766,00	215	5865251500	MDRG 1500GR	872,25	191
2513110280	KYNK AYR PNS BORU AĞZ 280	1.444,00	136	5865250001	MDRG YP SAP&KAMA 1000GR	108,50	243
2512110200	KYNK AYR PNS DÜZ AĞZ 200	1.444,00	136	5865250002	MDRG YP SAP&KAMA 1500GR	119,00	243
0637350140	KYŞ YAĞ FLT SÖKM 60-140	1.022,00	200	0345020008	MFSL CRC KMB ANH 08	659,25	81
5700240003	KYŞ ZMB 03	127,75	189	0345020009	MFSL CRC KMB ANH 09	672,50	81
5700240004	KYŞ ZMB 04	133,50	189	0345020010	MFSL CRC KMB ANH 10	699,75	81
5700240005	KYŞ ZMB 05	145,00	189	0345020011	MFSL CRC KMB ANH 11	721,25	81
5700240006	KYŞ ZMB 06	147,75	189	0345020012	MFSL CRC KMB ANH 12	762,50	81
5700240007	KYŞ ZMB 07	162,75	189	0345020013	MFSL CRC KMB ANH 13	795,25	81
5700240008	KYŞ ZMB 08	172,75	189	0345020014	MFSL CRC KMB ANH 14	836,25	81
5700240009	KYŞ ZMB 09	192,75	189	0345020015	MFSL CRC KMB ANH 15	877,25	81
5700240010	KYŞ ZMB 10	205,50	189	0345020016	MFSL CRC KMB ANH 16	955,00	81
5700240011	KYŞ ZMB 11	220,75	189	0345020017	MFSL CRC KMB ANH 17	967,25	81
5700240012	KYŞ ZMB 12	264,25	189	0345020018	MFSL CRC KMB ANH 18	1.041,25	81
5700240013	KYŞ ZMB 13	278,00	189	0345020019	MFSL CRC KMB ANH 19	1.088,25	81
5700240014	KYŞ ZMB 14	305,50	189	0345002112	MFSL CRC KMB ANH TK12	10.075,75	81
5700240015	KYŞ ZMB 15	350,00	189	0375350054	MKNK KBLO SYRC 0,5-4	947,00	195
5700240016	KYŞ ZMB 16	383,50	189	0741050010	MKR UZT KBLO MT10	2.015,25	201
5700240017	KYŞ ZMB 17	419,25	189	0741050025	MKR UZT KBLO MT25	3.561,25	201
5700240018	KYŞ ZMB 18	457,00	189	0741050050	MKR UZT KBLO MT50	7.110,75	201
5700240019	KYŞ ZMB 19	496,75	189	7400000100	MNGN (DNR TBL DHL) 100	5.916,00	203
5700240020	KYŞ ZMB 20	529,00	189	7400000125	MNGN (DNR TBL DHL) 125	8.070,25	203
5700002110	KYŞ ZMB TK10	1.772,75	189	7400000150	MNGN (DNR TBL DHL) 150	10.205,00	203



KOD	ÜRÜN	FİYAT	SAYFA	KOD	ÜRÜN	FİYAT	SAYFA
7400000175	MNGN (DNR TBL DHL) 175	12.340,25	203	3221131200	OPAK DÜZ UÇ KRGB 200 ELTA	424,75	235
7400300100	MNGN 100	4.570,00	203	4300170380	OPAK DÜZ UÇ TRNV 3X80	73,75	168
7400300125	MNGN 125	6.292,00	203	4150170380	OPAK DÜZ UÇ TRNV 3X80 ELTA	61,00	236
7400300150	MNGN 150	8.046,50	203	4300174100	OPAK DÜZ UÇ TRNV 4X100	90,75	168
7400300175	MNGN 175	9.900,00	203	4150174100	OPAK DÜZ UÇ TRNV 4X100 ELTA	74,75	236
7401300100	MNGN DNR TBL 100	1.346,00	203	4300170480	OPAK DÜZ UÇ TRNV 4X80	76,25	168
7401300125	MNGN DNR TBL 125	1.778,25	203	4150170480	OPAK DÜZ UÇ TRNV 4X80 ELTA	70,00	236
7401300150	MNGN DNR TBL 150	2.158,50	203	4300175100	OPAK DÜZ UÇ TRNV 5X100	109,50	168
7401300175	MNGN DNR TBL 175	2.440,25	203	4150175100	OPAK DÜZ UÇ TRNV 5X100 ELTA	89,75	236
8004316004	MNGN SHP	3.275,00	249	4300175125	OPAK DÜZ UÇ TRNV 5X125	127,75	168
0325020010	MNT ANH 10	140,50	76	4150175125	OPAK DÜZ UÇ TRNV 5X125 ELTA	103,75	236
0325020013	MNT ANH 13	156,75	76	4300176100	OPAK DÜZ UÇ TRNV 6X100	114,00	168
0325020017	MNT ANH 17	207,50	76	4150176100	OPAK DÜZ UÇ TRNV 6X100 ELTA	93,50	236
0325020019	MNT ANH 19	242,75	76	4300176125	OPAK DÜZ UÇ TRNV 6X125	130,00	168
0325020020	MNT ANH 20	247,25	76	4150176125	OPAK DÜZ UÇ TRNV 6X125 ELTA	106,00	236
0325020021	MNT ANH 21	287,50	76	4300176150	OPAK DÜZ UÇ TRNV 6X150	142,00	168
0325020022	MNT ANH 22	329,25	76	4150176150	OPAK DÜZ UÇ TRNV 6X150 ELTA	117,25	236
4780196120	MNY BİTS TUTC TRNV 6,3X120	298,25	173	4300177125	OPAK DÜZ UÇ TRNV 7X125	145,50	168
4785196330	MNY BİTS TUTC TRNV 6,3X30	162,75	173	4300177150	OPAK DÜZ UÇ TRNV 7X150	167,25	168
4788196160	MNY BİTS TUTC TRNV FLEX SNG 6,3X160	618,25	174	4150177150	OPAK DÜZ UÇ TRNV 7X150 ELTA	137,00	236
8779008741	MOTOSİKLET BKM SET42	3.640,25	63	4150178150	OPAK DÜZ UÇ TRNV 8X150 ELTA	148,50	236
7030291212	MSTR ÇEK 2KOL 12X12	1.442,25	222	4300178175	OPAK DÜZ UÇ TRNV 8X175	202,75	168
7030291616	MSTR ÇEK 2KOL 16X16	2.170,25	222	4150178175	OPAK DÜZ UÇ TRNV 8X175 ELTA	166,25	236
7030292320	MSTR ÇEK 2KOL 23X20	2.950,50	222	4300179200	OPAK DÜZ UÇ TRNV 9X200	267,75	168
7030290808	MSTR ÇEK 2KOL 8X8	699,75	222	4150008106	OPAK DÜZ&YLD UÇ TRNV SET6 ELTA	606,25	236
7040291212	MSTR ÇEK 3KOL 12X12	1.960,75	222	4300008107	OPAK DÜZ&YLD UÇ TRNV SET7	765,75	168
7040291616	MSTR ÇEK 3KOL 16X16	2.883,00	222	4150008107	OPAK DÜZ&YLD UÇ TRNV SET7 ELTA	726,50	236
7040292320	MSTR ÇEK 3KOL 23X20	3.881,75	222	3225132160	OPAK EĞRİ UÇ KRGB 160	525,50	139
7040290808	MSTR ÇEK 3KOL 8X8	1.340,00	222	3225132180	OPAK EĞRİ UÇ KRGB 180	594,00	139
7030291222	MSTR ÇEK YP KOL 12X12	238,25	245	3225132200	OPAK EĞRİ UÇ KRGB 200	634,25	139
7030291622	MSTR ÇEK YP KOL 16X16	425,00	245	3020122160	OPAK KMB PNS 160	447,00	137
7030292322	MSTR ÇEK YP KOL 23X20	578,25	245	3021121160	OPAK KMB PNS 160 ELTA	341,75	235
7030290822	MSTR ÇEK YP KOL 8X8	171,75	245	3020122180	OPAK KMB PNS 180	507,25	137
7030291244	MSTR ÇEK YP MİL 12X12	343,00	245	3021121180	OPAK KMB PNS 180 ELTA	418,25	235
7030291644	MSTR ÇEK YP MİL 16X16	379,00	245	3020122200	OPAK KMB PNS 200	572,00	137
7030292344	MSTR ÇEK YP MİL 23X20	519,00	245	3021121200	OPAK KMB PNS 200 ELTA	509,50	235
7030290844	MSTR ÇEK YP MİL 8X8	233,25	245	3020002003	OPAK PNS 160 SET3	1.504,75	139
4555170165	MSTR KNT KLM DÜZ UÇ 165	129,50	163	4325180360	OPAK PZ UÇ TRNV 3X60	88,75	168
14000005043	MTL GVD KLT MKT BÇK 18 ELTA	173,00	240	4325184580	OPAK PZ UÇ TRNV 4,5X80	127,75	168
6410250800	NCK 800GR	1.458,25	191	4325186100	OPAK PZ UÇ TRNV 6X100	153,25	168
6410250001	NCK YP SAP&KAMA 800GR	349,75	243	4325188150	OPAK PZ UÇ TRNV 8X150	290,75	168
5540244120	NKT ZMB 4X120	172,75	188	4320180360	OPAK YLD UÇ TRNV 3X60	81,50	168
5540245120	NKT ZMB 5X120	203,50	188	4170180360	OPAK YLD UÇ TRNV 3X60 ELTA	68,25	236
5540245150	NKT ZMB 5X150	225,25	188	4320184580	OPAK YLD UÇ TRNV 4,5X80	115,50	168
5540240412	NKT ZMB KKPL 4X120	170,75	188	4170184580	OPAK YLD UÇ TRNV 4,5X80 ELTA	92,50	236
3220132140	OPAK DÜZ UÇ KRGB 140	440,00	138	4320186100	OPAK YLD UÇ TRNV 6X100	139,75	168
3220132160	OPAK DÜZ UÇ KRGB 160	497,75	138	4170186100	OPAK YLD UÇ TRNV 6X100 ELTA	111,00	236
3221131160	OPAK DÜZ UÇ KRGB 160 ELTA	371,00	235	4320188150	OPAK YLD UÇ TRNV 8X150	264,50	168
3220132180	OPAK DÜZ UÇ KRGB 180	546,75	138	4170188150	OPAK YLD UÇ TRNV 8X150 ELTA	209,75	236
3220132200	OPAK DÜZ UÇ KRGB 200	579,75	138	3700162140	OPAK YNKS 140	465,00	140

KOD	ÜRÜN	FİYAT	SAYFA	KOD	ÜRÜN	FİYAT	SAYFA
3701161140	OPAK YNKS 140 ELTA	324,75	235	4880211003	PZ3 BİTS UÇ(100)	69,00	177
3700162160	OPAK YNKS 160	560,00	140	4880211503	PZ3 BİTS UÇ(150)	98,75	177
3701161160	OPAK YNKS 160 ELTA	381,25	235	4825210003	PZ3 BİTS UÇ(25)	20,25	177
3700162180	OPAK YNKS 180	652,75	140	4825210013	PZ3 BİTS UÇ(50)	35,25	177
4565170135	OTO KNT KLM 135	252,75	163	4880210703	PZ3 BİTS UÇ(75)	45,75	177
8705006113	OTO TİP HOB SET13	2.732,50	62	4825000003	PZ3 BİTS UÇ TK10(25)	202,50	177
8010316001	PANO	8.912,00	250	7126290018	RTL ÇEK 18	1.384,50	225
8011316001	PANO ELTA	7.375,75	239	7126290025	RTL ÇEK 25	1.898,25	225
0676050042	PLS BORU KSM MKS 42	2.365,25	218	7126290029	RTL ÇEK 29	2.524,75	225
0676050063	PLS BORU KSM MKS 63	4.149,25	218	7126290040	RTL ÇEK 40	3.563,75	225
0676550042	PLS BORU KSM MKS YP BÇK 42	1.224,25	244	7126290045	RTL ÇEK 45	4.499,50	225
0676550063	PLS BORU KSM MKS YP BÇK 63	2.273,00	244	0590150020	SENTİL 0,05-1	178,00	197
5850250030	PLS ÇKÇ 30	396,00	190	0590250020	SENTİL 2-35/1000 SAE	278,00	197
5850250040	PLS ÇKÇ 40	481,75	190	0639050125	SGM ÇMBR 125	871,25	201
5850250050	PLS ÇKÇ 50	610,75	190	0639050175	SGM ÇMBR 175	1.662,50	201
5850250130	PLS ÇKÇ YP BAŞLIK 30	89,75	243	3335001004	SGM PNS SET4	2.229,75	142
5850250140	PLS ÇKÇ YP BAŞLIK 40	127,75	243	14000004136	SIRT BTKÇ	1.859,25	65
5850250150	PLS ÇKÇ YP BAŞLIK 50	182,50	243	3425120220	SKŞTTİP HRTM KLPÇ PNS 235	956,50	144
0588150003	PLS ŞRT MT3	224,25	195	2510110250	SPCL AYR PNS 250	856,00	135
5884260003	PLS ŞRT MT3 ELTA	93,50	238	6220261000	SPRL MIKN 1000GR	592,50	197
0588150005	PLS ŞRT MT5	269,00	195	6220260500	SPRL MIKN 500GR	559,25	197
5884260005	PLS ŞRT MT5 ELTA	135,00	238	8501346001	SRVMASA	18.096,25	55
3020001002	PNS&KNT KLM SET2	566,75	139	8500346001	SRVMASA P	23.900,75	54
6195260260	PRÇN TBNC	888,75	197	2505110250	STD AYR PNS 250	856,00	135
14000005051	PRO GVN MKT BÇK OTO KLT TRAPEZ 2 YDK BÇK	457,75	208	6855280330	STD BORU KSC	706,00	218
14000005090	PRO GVN MKT TRAPEZ YP BÇK	73,00	210	7010291210	STD ÇEK 2KOL 12X10	1.857,25	221
14000005088	PRO MKT YP BÇK 18	57,75	210	7010291615	STD ÇEK 2KOL 16X15	3.165,25	221
14000005091	PRO MKT YP BÇK 30° 9	36,50	210	7010292015	STD ÇEK 2KOL 20X15	3.462,25	221
14000005089	PRO MKT YP BÇK 9	36,50	210	7010292520	STD ÇEK 2KOL 25X20	5.980,00	221
14000005050	PRO MTL GVD EMNY OTO KLT MKT BÇK 18	375,00	208	7010293520	STD ÇEK 2KOL 35X20	7.263,00	221
14000005048	PRO MTL GVD EMNY OTO KLT MKT BÇK 9	288,50	210	7010295220	STD ÇEK 2KOL 52X20	10.675,75	221
14000005049	PRO MTL GVD MKT BÇK 18	230,75	209	7010290810	STD ÇEK 2KOL 8X10	1.736,50	221
14000005053	PRO MTL GVD MKT BÇK 30° BÇK 9	48,00	210	7020293720	STD ÇEK 3KOL 37X20	13.401,75	221
14000005052	PRO MTL GVD MKT BÇK 9	163,50	210	7020295220	STD ÇEK 3KOL 52X20	18.475,00	221
14000005047	PRO MTL GVD MKT BÇK OTO YÜKL 5 YDK 9	240,50	209	7010291633	STD ÇEK YP BĞP 16X15-20X15	273,50	245
14000005148	PRO SIRT TKÇ	3.115,50	66	7010292533	STD ÇEK YP BĞP 25-35-37-52X20	479,00	245
6865281050	PROF BORU KSC	3.786,50	218	7010290833	STD ÇEK YP BĞP 8X10-12X10	159,00	245
6865280150	PROF BORU KSC YP BÇK	284,00	244	7010291622	STD ÇEK YP KOL 16X15-20X15	546,00	245
4880211001	PZ1 BİTS UÇ(100)	69,00	177	7010292522	STD ÇEK YP KOL 25-35-37-52X20	956,50	245
4880211501	PZ1 BİTS UÇ(150)	98,75	177	7010290822	STD ÇEK YP KOL 8X10-12X10	314,00	245
4825210001	PZ1 BİTS UÇ(25)	20,25	177	7010291644	STD ÇEK YP MİL 16X15-20X15	547,75	245
4825210011	PZ1 BİTS UÇ(50)	35,25	177	7010292544	STD ÇEK YP MİL 25X20	942,50	245
4880210701	PZ1 BİTS UÇ(75)	45,75	177	7010293544	STD ÇEK YP MİL 35X20-37X20	1.228,25	245
4825000001	PZ1 BİTS UÇ TK10(25)	202,50	177	7010295244	STD ÇEK YP MİL 52X20	1.228,25	245
4880211002	PZ2 BİTS UÇ(100)	69,00	177	7010290844	STD ÇEK YP MİL 8X10-12X10	287,25	245
4880211502	PZ2 BİTS UÇ(150)	98,75	177	7010292033	STD ÇEK YP UZP 200	417,00	245
4825210002	PZ2 BİTS UÇ(25)	20,25	177	7010293033	STD ÇEK YP UZP 300	725,75	245
4825210012	PZ2 BİTS UÇ(50)	35,25	177	7010294033	STD ÇEK YP UZP 400	1.073,50	245
4880210702	PZ2 BİTS UÇ(75)	45,75	177	2100100010	STİLSON BORU ANH 10"	991,25	133
4825000002	PZ2 BİTS UÇ TK10(25)	202,50	177	2100100012	STİLSON BORU ANH 12"	1.115,25	133



KOD	ÜRÜN	FİYAT	SAYFA	KOD	ÜRÜN	FİYAT	SAYFA
2100100014	STİLSON BORU ANH 14"	1.369,00	133	8420336305	TKÇ GÖZ5 520	2.144,50	59
2100100018	STİLSON BORU ANH 18"	1.737,75	133	8420336405	TKÇ GÖZ5 600	2.260,00	59
2100100024	STİLSON BORU ANH 24"	2.799,00	133	8440331016	TKÇ PLS 16"	532,25	62
2100100008	STİLSON BORU ANH 8"	824,00	133	8440331019	TKÇ PLS 19"	744,75	62
2100100210	STİLSON BORU ANH YP BĞP 10"	569,75	242	8440331022	TKÇ PLS 22"	1.219,75	62
2100100212	STİLSON BORU ANH YP BĞP 12"	624,00	242	8440001023	TKÇ PLS ELKT SET23 19"	6.020,50	159
2100100214	STİLSON BORU ANH YP BĞP 14"	753,25	242	8445331028	TKÇ PLS TKR 28"	2.939,75	62
2100100218	STİLSON BORU ANH YP BĞP 18"	863,25	242	8160326001	TKD	12.072,50	47
2100100224	STİLSON BORU ANH YP BĞP 24"	1.290,50	242	13000005589	TKD 1.ÇKM SAĞ GRND MSTR SET 6	3.129,00	7
2100100208	STİLSON BORU ANH YP BĞP 8"	383,75	242	13000005568	TKD 1.ÇKM SET 18 ELKTRO	6.605,00	22
2100100110	STİLSON BORU ANH YP ÇENE 10"	371,00	242	8243001030	TKD 1.ÇKM SET 30 ECO	4.271,00	37
2100100112	STİLSON BORU ANH YP ÇENE 12"	413,75	242	13000005573	TKD 1.ÇKM SET 30 ELITE	4.543,00	30
2100100114	STİLSON BORU ANH YP ÇENE 14"	498,75	242	8242001030	TKD 1.ÇKM SET 30 GRJ	4.543,00	26
2100100118	STİLSON BORU ANH YP ÇENE 18"	670,75	242	8241001030	TKD 1.ÇKM SET 30 PROMOB	4.543,00	18
2100100124	STİLSON BORU ANH YP ÇENE 24"	960,25	242	8244001030	TKD 1.ÇKM SET 30 TRND	4.271,00	39
2100100108	STİLSON BORU ANH YP ÇENE 8"	250,75	242	8245001042	TKD 1.ÇKM SET 42 PRM	9.011,50	14
2100100310	STİLSON BORU ANH YP SMN 10"	205,50	242	8235001072	TKD 1.ÇKM SET 69 PART	10.194,50	34
2100100312	STİLSON BORU ANH YP SMN 12"	214,50	242	13000005590	TKD 1.ÇKM SOL GRND MSTR SET 23	5.020,25	7
2100100314	STİLSON BORU ANH YP SMN 14"	239,25	242	13000005592	TKD 2.ÇKM SAĞ GRND MSTR SET 13	4.092,00	7
2100100318	STİLSON BORU ANH YP SMN 18"	330,25	242	13000005569	TKD 2.ÇKM SET 16 ELKTRO	14.065,75	22
2100100324	STİLSON BORU ANH YP SMN 24"	361,25	242	8235002031	TKD 2.ÇKM SET 31 PART	4.526,00	35
2100100308	STİLSON BORU ANH YP SMN 8"	186,00	242	8243002052	TKD 2.ÇKM SET 49 ECO	6.471,50	37
7070292013	STİP ÇEK 2KOL 20X13	1.916,50	223	8244002052	TKD 2.ÇKM SET 49 TRND	6.471,50	39
7080292013	STİP ÇEK 3KOL 20X13	2.471,50	223	13000005574	TKD 2.ÇKM SET 69 ELITE	9.054,00	30
7070292022	STİP ÇEK YP KOL 20X13	343,75	245	8242002072	TKD 2.ÇKM SET 69 GRJ	9.054,00	26
7070292044	STİP ÇEK YP MİL 20X13	479,25	245	8241002072	TKD 2.ÇKM SET 69 PROMOB	9.054,00	18
0588050100	SU TRZ 100CM	1.254,50	196	8245002094	TKD 2.ÇKM SET 91 PRM	10.001,00	14
0588050120	SU TRZ 120CM	1.484,00	196	13000005591	TKD 2.ÇKM SOL GRND MSTR SET 13	2.470,50	7
0588050150	SU TRZ 150CM	1.710,25	196	13000005593	TKD 3.ÇKM SAĞ GRND MSTR SET 10	10.002,00	8
0588050200	SU TRZ 200CM	2.389,25	196	13000005575	TKD 3.ÇKM SET 10 ELITE	6.190,75	31
0588050040	SU TRZ 40CM	806,00	196	8242003010	TKD 3.ÇKM SET 10 GRJ	6.190,75	27
0588050050	SU TRZ 50CM	873,75	196	8243003013	TKD 3.ÇKM SET 13 ECO	4.554,75	37
0588050060	SU TRZ 60CM	949,75	196	8244003013	TKD 3.ÇKM SET 13 TRND	4.554,75	39
0588050070	SU TRZ 70CM	1.020,00	196	8245003014	TKD 3.ÇKM SET 14 PRM	4.657,25	14
0588050080	SU TRZ 80CM	1.102,00	196	8235003017	TKD 3.ÇKM SET 17 PART	4.401,00	35
13000005399	SYND DAR 300X400X1800	4.890,00	48	8241003051	TKD 3.ÇKM SET 51 PROMOB	4.298,25	18
13000005564	SYND DAR 300X400X450	1.955,00	51	13000005570	TKD 3.ÇKM SET 8 ELKTRO	7.492,25	23
13000005566	SYND DAR 300X400X900	2.935,00	50	13000005594	TKD 3.ÇKM SOL GRND MSTR SET 8	6.896,00	8
13000005400	SYND GNŞ 400X400X1800	5.950,00	49	13000005596	TKD 4.ÇKM SAĞ GRND MSTR SET 48	4.915,75	9
13000005565	SYND GNŞ 400X400X450	2.380,00	51	13000005576	TKD 4.ÇKM SET 18 ELITE	3.491,00	31
13000005567	SYND GNŞ 400X400X900	3.570,00	50	8242004018	TKD 4.ÇKM SET 18 GRJ	3.491,00	27
6815270200	TEL KSM MKS 200	354,50	215	8241004027	TKD 4.ÇKM SET 27 PROMOB	7.477,00	19
13000005538	TKÇ ELEKTRO SET24	15.120,25	65	8245004043	TKD 4.ÇKM SET 43 PRM	5.320,00	15
8410336103	TKÇ GÖZ3 300	1.012,50	59	13000005571	TKD 4.ÇKM SET 51 ELKTRO	6.723,25	23
8410336203	TKÇ GÖZ3 420	1.210,50	59	13000005595	TKD 4.ÇKM SOL GRND MSTR SET 24	5.381,75	9
8420336105	TKÇ GÖZ5 300	1.782,00	59	13000005598	TKD 5.ÇKM SOL GRND MSTR SET 45	9.784,25	10
8420336205	TKÇ GÖZ5 420	1.845,25	59	13000005597	TKD 5.ÇKM SAĞ GRND MSTR SET 33	16.310,25	10
8420005046	TKÇ GÖZ5 420 ELKT SET45	12.291,50	61	8241005010	TKD 5.ÇKM SET 10 PROMOB	6.190,75	19
8420005063	TKÇ GÖZ5 420 MKNK SET62	10.773,25	61	13000005577	TKD 5.ÇKM SET 11 ELITE	2.766,00	31
8420005028	TKÇ GÖZ5 420 TSTÇ SET28	10.601,00	61	8242005011	TKD 5.ÇKM SET 11 GRJ	2.766,00	27

KOD	ÜRÜN	FİYAT	SAYFA	KOD	ÜRÜN	FİYAT	SAYFA
8245005043	TKD 5.ÇKM SET43 PRM	5.732,75	15	8245007096	TKD ÇKM7 SET250 PRM	67.051,00	13
13000005599	TKD 6.ÇKM SAĞ GRND MSTR SET 16	12.363,50	11	8245321007	TKD ÇKM7 SYH PRM	26.721,75	13
8245006009	TKD 6.ÇKM SET16 PRM	5.606,75	15	8242323008	TKD ÇKM8 GRİ GRİ GRJ	28.790,25	25
8241006018	TKD 6.ÇKM SET18 PROMOB	3.491,00	19	8241323008	TKD ÇKM8 GRİ GRİ PROMOB	29.051,00	17
13000005600	TKD 6.ÇKM SOL GRND MSTR SET 8	5.421,50	11	8241321008	TKD ÇKM8 GRİ KRMZ PROMOB	29.051,00	17
8247321007	TKD AŞŞAP ÜST TBL KRMZ ANT WB	29.857,00	41	8241322008	TKD ÇKM8 GRİ MAVİ PROMOB	29.051,00	17
8246321007	TKD AŞŞAP ÜST TBL KRMZ ANT XXL	31.815,50	40	8242321008	TKD ÇKM8 KRMZ GRİ GRJ	28.790,25	25
8243321003	TKD ÇKM3 KRMZ GRİ ECO	12.657,00	36	8242008142	TKD ÇKM8 KRMZ SET139 GRJ	54.835,00	25
13000005562	TKD ÇKM3 KRMZ SYH TRND	12.455,00	38	8241001209	TKD ÇKM8 KRMZ SET206 PROMOB	64.105,00	17
8243323005	TKD ÇKM5 GRİ GRİ ECO	12.657,00	36	8242322008	TKD ÇKM8 MAVİ GRİ GRJ	28.790,25	25
8242323005	TKD ÇKM5 GRİ GRİ GRJ	19.070,00	25	13000005279	TKD GRİ KRMZ MINI PROMOB	11.870,00	16
8241323005	TKD ÇKM5 GRİ GRİ PROMOB	21.342,25	17	13000005561	TKD KRMZ MINI PART	11.515,00	32
8241321005	TKD ÇKM5 GRİ KRMZ PROMOB	21.342,25	17	8210326001	TKD VGN	13.385,75	46
8241322005	TKD ÇKM5 GRİ MAVİ PROMOB	21.342,25	17	8015316001	TKR 3GEN PANO	4.644,00	249
8243321005	TKD ÇKM5 KRMZ GRİ ECO	12.657,00	36	14000004293	TKR TAMİRCİ KIZ BYK 500X1010 SYH	2.015,75	205
8242321005	TKD ÇKM5 KRMZ GRİ GRJ	19.070,00	25	14000004294	TKR TAMİRCİ KIZ KÇK 400X900 SYH	1.459,75	205
8235326005	TKD ÇKM5 KRMZ PART	17.350,00	33	6860280635	TL SK BORU KSC	1.500,75	218
8235006121	TKD ÇKM5 KRMZ SET118 PART	36.471,50	33	6820270200	TNK MKS 200	580,00	214
8243001096	TKD ÇKM5 KRMZ SET93 ECO	27.954,25	36	6820270250	TNK MKS 250	741,25	214
8244005096	TKD ÇKM5 KRMZ SET93 TRND	28.004,75	38	6820270300	TNK MKS 300	807,75	214
8244321005	TKD ÇKM5 KRMZ SYH TRND	12.707,50	38	6821270250	TNK MKS YAY 250	805,00	214
8243322005	TKD ÇKM5 MAVİ GRİ ECO	12.657,00	36	6821270300	TNK MKS YAY 300	880,25	214
8242322005	TKD ÇKM5 MAVİ GRİ GRJ	19.070,00	25	4910220010	TORX ALLEN ANH T10	98,75	181
8235325005	TKD ÇKM5 MAVİ PART	17.350,00	33	4910220015	TORX ALLEN ANH T15	101,50	181
8235327005	TKD ÇKM5 SYH PART	17.350,00	33	4910220020	TORX ALLEN ANH T20	106,75	181
8245321005	TKD ÇKM5 SYH PRM	20.641,75	13	4910220025	TORX ALLEN ANH T25	106,75	181
8242323006	TKD ÇKM6 GRİ GRİ GRJ	22.446,50	25	4910220027	TORX ALLEN ANH T27	106,75	181
8241323006	TKD ÇKM6 GRİ GRİ PROMOB	23.062,00	17	4910220030	TORX ALLEN ANH T30	114,00	181
8241321006	TKD ÇKM6 GRİ KRMZ PROMOB	23.062,00	17	4910220040	TORX ALLEN ANH T40	121,50	181
8241322006	TKD ÇKM6 GRİ MAVİ PROMOB	23.062,00	17	4910220045	TORX ALLEN ANH T45	148,75	181
8242321006	TKD ÇKM6 KRMZ GRİ GRJ	22.446,50	25	4910220050	TORX ALLEN ANH T50	169,25	181
8242322006	TKD ÇKM6 MAVİ GRİ GRJ	22.446,50	25	4910220055	TORX ALLEN ANH T55	234,75	181
8243323007	TKD ÇKM7 GRİ GRİ ECO	16.968,25	36	4910220060	TORX ALLEN ANH T60	323,25	181
8242323007	TKD ÇKM7 GRİ GRİ GRJ	26.226,00	25	4910220066	TORX ALLEN ANH T66	323,25	181
8241323007	TKD ÇKM7 GRİ GRİ PROMOB	27.253,50	17	4910220077	TORX ALLEN ANH T77	98,00	181
8241321007	TKD ÇKM7 GRİ KRMZ PROMOB	27.253,50	17	4910220088	TORX ALLEN ANH T88	98,00	181
8241322007	TKD ÇKM7 GRİ MAVİ PROMOB	27.253,50	17	4910220099	TORX ALLEN ANH T99	98,75	181
13000005434	TKD ÇKM7 KRMZ ANT XXL SET252 GRND MSTR	119.292,25	6	4910007108	TORX ALLEN ANH TK8	854,75	181
8243321007	TKD ÇKM7 KRMZ GRİ ECO	16.968,25	36	4885211025	TORX BİTS UÇ T25(100)	70,00	177
8242321007	TKD ÇKM7 KRMZ GRİ GRJ	26.226,00	25	4885211525	TORX BİTS UÇ T25(150)	100,25	177
13000005548	TKD ÇKM7 KRMZ SARI ELEKTRO SET94	63.426,25	21	4830210025	TORX BİTS UÇ T25(25)	27,50	177
13000005547	TKD ÇKM7 KRMZ SARI ELKETRO	28.540,00	21	4830210125	TORX BİTS UÇ T25(50)	35,25	177
8242001142	TKD ÇKM7 KRMZ SET139 GRJ	52.270,75	25	4885210725	TORX BİTS UÇ T25(75)	48,50	177
8243007096	TKD ÇKM7 KRMZ SET93 ECO	32.265,50	36	4830000025	TORX BİTS UÇ T25 TK10(25)	275,00	177
8244007096	TKD ÇKM7 KRMZ SET93 TRND	28.528,75	38	4885211027	TORX BİTS UÇ T27(100)	70,00	177
13000005563	TKD ÇKM7 KRMZ SYH ELITE	21.255,00	29	4885211527	TORX BİTS UÇ T27(150)	100,25	177
13000005572	TKD ÇKM7 KRMZ SYH ELITE SET139	47.299,75	29	4830210027	TORX BİTS UÇ T27(25)	27,50	177
8244321007	TKD ÇKM7 KRMZ SYH TRND	13.231,50	38	4830210127	TORX BİTS UÇ T27(50)	35,25	177
8243322007	TKD ÇKM7 MAVİ GRİ ECO	16.968,25	36	4885210727	TORX BİTS UÇ T27(75)	48,50	177
8242322007	TKD ÇKM7 MAVİ GRİ GRJ	26.226,00	25	4830000027	TORX BİTS UÇ T27 TK10(25)	275,00	177



KOD	ÜRÜN	FIYAT	SAYFA	KOD	ÜRÜN	FIYAT	SAYFA
4885211030	TORX BİTS UÇ T30(100)	70,00	177	5800250020	TSVY ÇKÇ YP SAP&KAMA 2000GR	182,25	243
4885211530	TORX BİTS UÇ T30(150)	100,25	177	5800250002	TSVY ÇKÇ YP SAP&KAMA 200GR	92,50	243
4830210030	TORX BİTS UÇ T30(25)	27,50	177	5800250003	TSVY ÇKÇ YP SAP&KAMA 300GR	103,75	243
4830210130	TORX BİTS UÇ T30(50)	35,25	177	5800250005	TSVY ÇKÇ YP SAP&KAMA 500GR	116,25	243
4885210730	TORX BİTS UÇ T30(75)	48,50	177	5510230125	TSVY DÜZ KSK 125	204,50	188
4830000030	TORX BİTS UÇ T30 TK10(25)	275,00	177	5510230150	TSVY DÜZ KSK 150	255,25	188
4885211040	TORX BİTS UÇ T40(100)	70,00	177	14000005070	TSVY MNGN 100	3.702,00	204
4885211540	TORX BİTS UÇ T40(150)	100,25	177	14000005069	TSVY MNGN 125	4.807,75	204
4830210040	TORX BİTS UÇ T40(25)	27,50	177	14000005072	TSVY MNGN 150	7.980,75	204
4830210140	TORX BİTS UÇ T40(50)	35,25	177	14000005071	TSVY MNGN 175	9.548,00	204
4885210740	TORX BİTS UÇ T40(75)	48,50	177	14000005126	TSVY MNGN DNR TBL 100	849,00	204
4830000040	TORX BİTS UÇ T40 TK10(25)	275,00	177	14000005127	TSVY MNGN DNR TBL 125	1.058,75	204
0380020008	TORX KMB ANH 08	190,50	83	14000005128	TSVY MNGN DNR TBL 150	1.340,50	204
0380020009	TORX KMB ANH 09	193,75	83	14000005129	TSVY MNGN DNR TBL 175	1.471,25	204
0380020010	TORX KMB ANH 10	214,50	83	4920220030	TTİP 6KŞ ALLEN ANH 03	137,50	183
0380020011	TORX KMB ANH 11	226,25	83	4920220040	TTİP 6KŞ ALLEN ANH 04	154,50	183
0380020012	TORX KMB ANH 12	232,25	83	4920220050	TTİP 6KŞ ALLEN ANH 05	164,75	183
0380020013	TORX KMB ANH 13	254,75	83	4920220060	TTİP 6KŞ ALLEN ANH 06	188,00	183
0380020014	TORX KMB ANH 14	282,00	83	4920220070	TTİP 6KŞ ALLEN ANH 07	197,50	183
0380020015	TORX KMB ANH 15	298,25	83	4920220080	TTİP 6KŞ ALLEN ANH 08	232,00	183
0380020017	TORX KMB ANH 17	323,75	83	4920220100	TTİP 6KŞ ALLEN ANH 10	351,00	183
0380020018	TORX KMB ANH 18	351,75	83	4920220025	TTİP 6KŞ ALLEN ANH 2,5	135,00	183
0380020019	TORX KMB ANH 19	380,25	83	4920008108	TTİP 6KŞ ALLEN ANH TK8	1.560,25	183
0380020022	TORX KMB ANH 22	511,75	83	4921220030	TTİP 6KŞ YVRL BAŞL ALLEN ANH 03	177,75	183
0380002112	TORX KMB ANH TK12	3.459,75	83	4921220040	TTİP 6KŞ YVRL BAŞL ALLEN ANH 04	199,00	183
0380002108	TORX KMB ANH TK8	2.016,00	83	4921220050	TTİP 6KŞ YVRL BAŞL ALLEN ANH 05	213,50	183
4775180010	TORX UÇ TRNV T10	115,25	172	4921220060	TTİP 6KŞ YVRL BAŞL ALLEN ANH 06	244,50	183
4775180015	TORX UÇ TRNV T15	115,25	172	4921220070	TTİP 6KŞ YVRL BAŞL ALLEN ANH 07	256,00	183
4775180020	TORX UÇ TRNV T20	127,75	172	4921220080	TTİP 6KŞ YVRL BAŞL ALLEN ANH 08	275,00	183
4775180025	TORX UÇ TRNV T25	147,75	172	4921220100	TTİP 6KŞ YVRL BAŞL ALLEN ANH 10	456,00	183
4775180027	TORX UÇ TRNV T27	162,75	172	4921220025	TTİP 6KŞ YVRL BAŞL ALLEN ANH 2,5	175,25	183
4775180030	TORX UÇ TRNV T30	172,75	172	4921008108	TTİP 6KŞ YVRL BAŞL ALLEN ANH TK8	1.997,00	183
4775180040	TORX UÇ TRNV T40	215,00	172	4922220030	TTİP ALLEN ANH 03 ELTA	112,00	237
4775180045	TORX UÇ TRNV T45	242,75	172	4922220040	TTİP ALLEN ANH 04 ELTA	113,75	237
4775008107	TORX UÇ TRNV TK7	1.056,50	172	4922220050	TTİP ALLEN ANH 05 ELTA	128,25	237
5520230125	TRN KSK 130	229,50	188	4922220060	TTİP ALLEN ANH 06 ELTA	140,75	237
5520230150	TRN KSK 150	273,25	188	4922220070	TTİP ALLEN ANH 07 ELTA	145,75	237
3860260180	TSTR ÇPRZ	742,00	146	4922220080	TTİP ALLEN ANH 08 ELTA	175,50	237
5891260830	TSTR KOL 300 ELTA	334,00	238	4922220100	TTİP ALLEN ANH 10 ELTA	306,25	237
0589050830	TSTR KOL 30CM	842,50	196	4922220025	TTİP ALLEN ANH 2,5 ELTA	111,75	237
5800251000	TSVY ÇKÇ 1000GR	611,50	190	4922008108	TTİP ALLEN ANH TK8 ELTA	1.234,00	237
5800250100	TSVY ÇKÇ 100GR	277,00	190	4765190040	TTİP LKM UÇ TRNV 04	203,50	171
5800251500	TSVY ÇKÇ 1500GR	802,75	190	4765190050	TTİP LKM UÇ TRNV 05	203,50	171
5800252000	TSVY ÇKÇ 2000GR	987,00	190	4765190060	TTİP LKM UÇ TRNV 06	203,50	171
5800250200	TSVY ÇKÇ 200GR	302,00	190	4765190070	TTİP LKM UÇ TRNV 07	217,00	171
5800250300	TSVY ÇKÇ 300GR	365,75	190	4765190080	TTİP LKM UÇ TRNV 08	217,00	171
5800250500	TSVY ÇKÇ 500GR	423,00	190	4765190090	TTİP LKM UÇ TRNV 09	241,00	171
5800250010	TSVY ÇKÇ YP SAP&KAMA 1000GR	150,25	243	4765190100	TTİP LKM UÇ TRNV 10	241,00	171
5800250001	TSVY ÇKÇ YP SAP&KAMA 100GR	92,25	243	4765190110	TTİP LKM UÇ TRNV 11	266,25	171
5800250015	TSVY ÇKÇ YP SAP&KAMA 1500GR	169,25	243	4765190120	TTİP LKM UÇ TRNV 12	274,75	171

KOD	ÜRÜN	FİYAT	SAYFA	KOD	ÜRÜN	FİYAT	SAYFA
4765190130	TTİP LKM UÇ TRNV 13	287,50	171	0750050145	YLD ÇAK ANH 145		88
4765190140	TTİP LKM UÇ TRNV 14	334,00	171	0750050150	YLD ÇAK ANH 150		88
4765190055	TTİP LKM UÇ TRNV 5,5	203,50	171	0750050155	YLD ÇAK ANH 155		88
4795190010	TTİP MNY BİTS TUTC TRNV 6,3X130	316,00	174	0750050160	YLD ÇAK ANH 160		88
4909220010	TTİP TORX ALLEN ANH T10	254,75	182	0750050165	YLD ÇAK ANH 165		88
4909220015	TTİP TORX ALLEN ANH T15	260,00	182	0750050170	YLD ÇAK ANH 170		88
4909220020	TTİP TORX ALLEN ANH T20	262,25	182	0750050180	YLD ÇAK ANH 180		88
4909220025	TTİP TORX ALLEN ANH T25	268,00	182	0750050024	YLD ÇAK ANH 24	477,25	88
4909220027	TTİP TORX ALLEN ANH T27	298,00	182	0750050027	YLD ÇAK ANH 27	569,75	88
4909220030	TTİP TORX ALLEN ANH T30	306,25	182	0750050030	YLD ÇAK ANH 30	679,50	88
4909220040	TTİP TORX ALLEN ANH T40	317,75	182	0750050032	YLD ÇAK ANH 32	781,00	88
4909220009	TTİP TORX ALLEN ANH T9	249,75	182	0750050036	YLD ÇAK ANH 36	883,75	88
4909008108	TTİP TORX ALLEN ANH TK8	2.216,75	182	0750050038	YLD ÇAK ANH 38	1.058,25	88
6401250600	USTA KSR 400GR	805,25	191	0750050041	YLD ÇAK ANH 41	1.155,25	88
2500110250	ÜNV AYR PNS 250	856,00	135	0750050042	YLD ÇAK ANH 42	1.320,75	88
7090292222	ÜNV ÇEK 2KOL 22X22	2.129,50	223	0750050046	YLD ÇAK ANH 46	1.381,00	88
7100292222	ÜNV ÇEK 3KOL 22X22	2.791,50	223	0750050047	YLD ÇAK ANH 47	1.524,00	88
7090292322	ÜNV ÇEK YP KOL 22X22	382,00	245	0750050050	YLD ÇAK ANH 50	1.630,50	88
7090292244	ÜNV ÇEK YP MİL 22X22	504,75	245	0750050055	YLD ÇAK ANH 55	2.293,50	88
2400110160	ÜNV FORT PNS 160	514,00	134	0750050060	YLD ÇAK ANH 60	2.488,50	88
2400110240	ÜNV FORT PNS 240	718,75	134	0750050065	YLD ÇAK ANH 65	3.253,00	88
2400110315	ÜNV FORT PNS 315	1.177,00	134	0750050070	YLD ÇAK ANH 70	3.724,25	88
4790266360	ÜNV MNY BİTS ADP 6,3X60	142,25	173	0750050075	YLD ÇAK ANH 75	3.986,25	88
6370260100	YAĞ FLT SÖKM 100	417,00	199	0750050080	YLD ÇAK ANH 80	5.661,50	88
4870211001	YLD BİTS UÇ PH1(100)	68,25	176	0750050085	YLD ÇAK ANH 85	6.369,75	88
4870211501	YLD BİTS UÇ PH1(150)	96,00	176	0750050090	YLD ÇAK ANH 90	7.835,25	88
4820210001	YLD BİTS UÇ PH1(25)	18,50	176	0750050095	YLD ÇAK ANH 95	8.835,00	88
4820210011	YLD BİTS UÇ PH1(50)	33,25	176	3705165160	YNKSK İNCE UÇ 160	728,25	142
4870210701	YLD BİTS UÇ PH1(75)	44,50	176	0530040810	YRM AY YLD ANH 0810	169,25	87
4870211002	YLD BİTS UÇ PH2(100)	68,25	176	0531041214	YRM AY YLD ANH 1/2X9/16 SAE	284,50	87
4870211502	YLD BİTS UÇ PH2(150)	96,00	176	0530041011	YRM AY YLD ANH 1011	198,50	87
4820210002	YLD BİTS UÇ PH2(25)	18,50	176	0530041012	YRM AY YLD ANH 1012	198,50	87
4820210012	YLD BİTS UÇ PH2(50)	33,25	176	0530041113	YRM AY YLD ANH 1113	198,50	87
4870210702	YLD BİTS UÇ PH2(75)	44,50	176	0530041315	YRM AY YLD ANH 1315	236,50	87
4870211003	YLD BİTS UÇ PH3(100)	68,25	176	0530041317	YRM AY YLD ANH 1317	236,50	87
4870211503	YLD BİTS UÇ PH3(150)	96,00	176	0530041417	YRM AY YLD ANH 1417	236,50	87
4820210003	YLD BİTS UÇ PH3(25)	18,50	176	0530041517	YRM AY YLD ANH 1517	236,50	87
4820210013	YLD BİTS UÇ PH3(50)	33,25	176	0530041922	YRM AY YLD ANH 1922	307,25	87
4870210703	YLD BİTS UÇ PH3(75)	44,50	176	0531041922	YRM AY YLD ANH 3/4X7/8 SAE	369,25	87
4820000001	YLD BİTS UÇ TK10 PH1(25)	185,00	176	0531040911	YRM AY YLD ANH 3/8X7/16 SAE		87
4820000002	YLD BİTS UÇ TK10 PH2(25)	185,00	176	0531040809	YRM AY YLD ANH 5/16X3/8 SAE		87
4820000003	YLD BİTS UÇ TK10 PH3(25)	185,00	176	0531041112	YRM AY YLD ANH 7/16X1/2 SAE	244,75	87
0750050100	YLD ÇAK ANH 100	10.213,50	88	0531041417	YRM AY YLD ANH 9/16X11/16 SAE		87
0750050105	YLD ÇAK ANH 105	10.543,00	88	0531041416	YRM AY YLD ANH 9/16X5/8 SAE	293,00	87
0750050110	YLD ÇAK ANH 110	11.270,50	88	14000005036	ZNCR BORU ANH 4"	6.730,75	133
0750050115	YLD ÇAK ANH 115	12.633,50	88	14000005037	ZNCR BORU ANH 6"	9.134,50	133
0750050120	YLD ÇAK ANH 120	17.363,25	88	14000005140	ZNCR BORU ANH 8"	15.384,50	133
0750050125	YLD ÇAK ANH 125		88	14000005039	ZNCR BORU ANH YP 4"	1.653,75	133
0750050130	YLD ÇAK ANH 130		88	14000005038	ZNCR BORU ANH YP 6"	2.884,50	133
0750050135	YLD ÇAK ANH 135		88	14000005139	ZNCR BORU ANH YP 8"	3.365,50	133
0750050140	YLD ÇAK ANH 140		88	0637450140	ZNCR YAĞ FLT SÖKM 60-140	880,75	200





İŞIKKENT FABRİKASI



58.280 M² Açık 24.320 M² Kapalı Alan

TURGUTLU FABRİKASI



40.415 M² Açık 13.120 M² Kapalı Alan

SÜTÇÜLER FABRİKASI



41.225 M² Açık 14.050 M² Kapalı Alan

ALİAĞA FABRİKASI



50.000 M² Arsa



İzeltaş El Aletleri Sanayi ve Ticaret A.Ş.

Kemalpaşa Cad. No: 303
Işıkkent / İzmir / TÜRKİYE

Sipariş Telefon
Phone for Orders

DT: +90 232 472 13 92
T: +90 232 472 13 75
F: +90 232 472 13 78

Adana Bölge Müdürlüğü
Adana Office

+90 533 495 53 09

Ankara Bölge Müdürlüğü
Ankara Office

+90 533 603 47 29

İstanbul Bölge Müdürlüğü
Istanbul Office

+90 533 603 41 81
+90 535 461 54 87



ANDROID APP ON
Google play

Download on the
App Store

izeltas_

/izeltaselaletleri

İZELTAŞ

izeltas A.S.

www.izeltas.com.tr